

SIGN PUNCHING, STRINGER AND SUPPORT LOCATION DETAILS - ROUTE MARKER SIGNS

D-754-72

Notes:

1. Use 0.100 inch minimum thickness sign backing material.
2. Use 1 1/2"x1 1/2" perforated square tube stringers.
3. Punch holes round for 3/8" bolt.

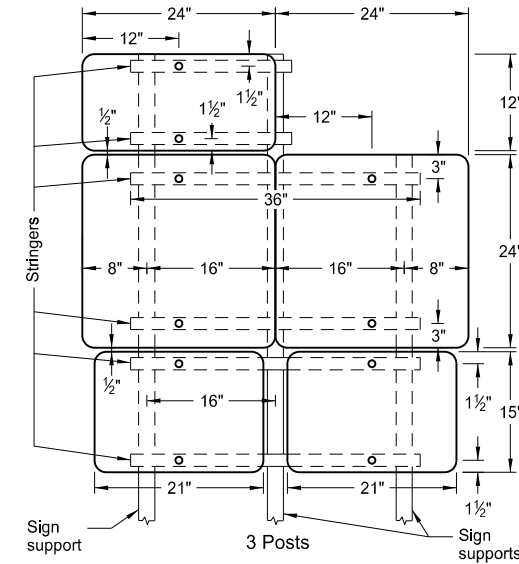
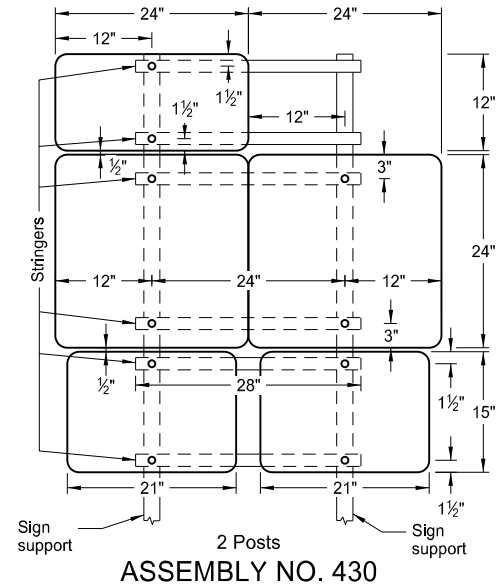
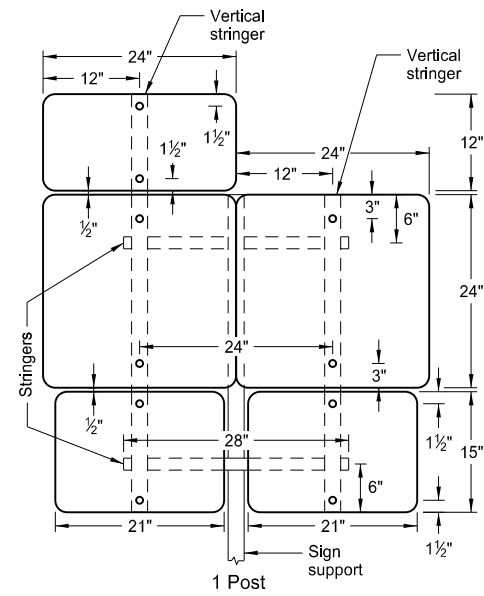

ASSEMBLY NO. 430

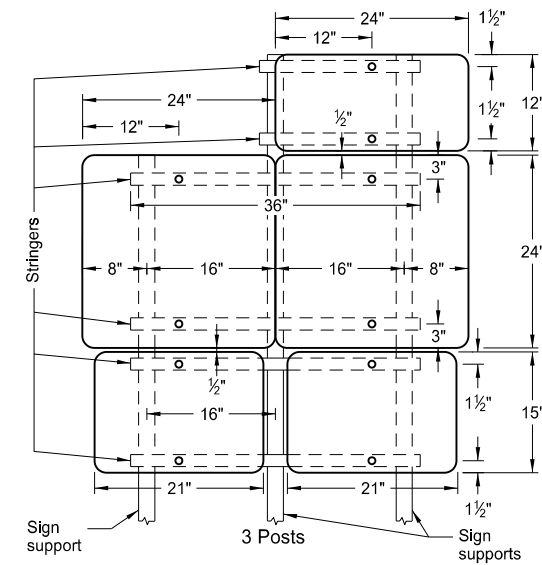
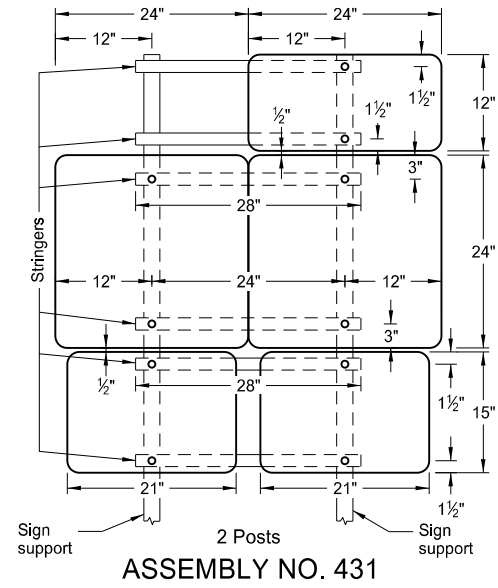
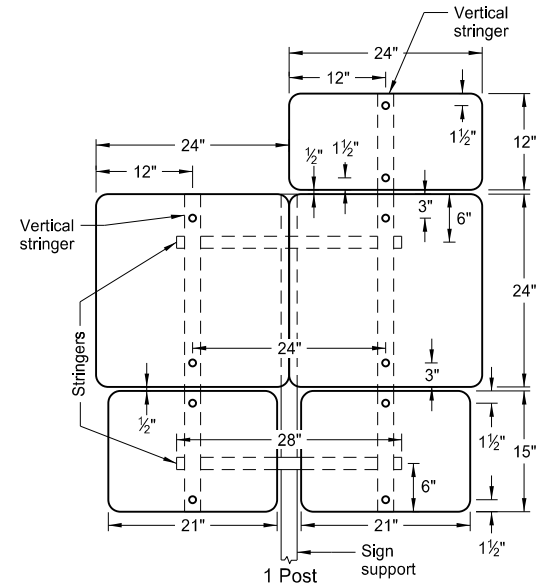

ASSEMBLY NO. 431

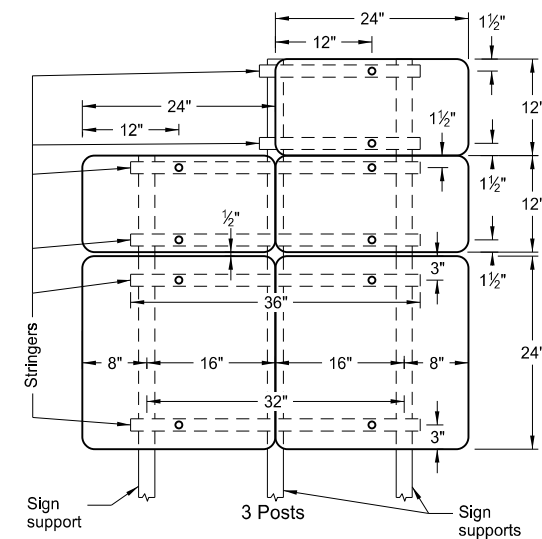
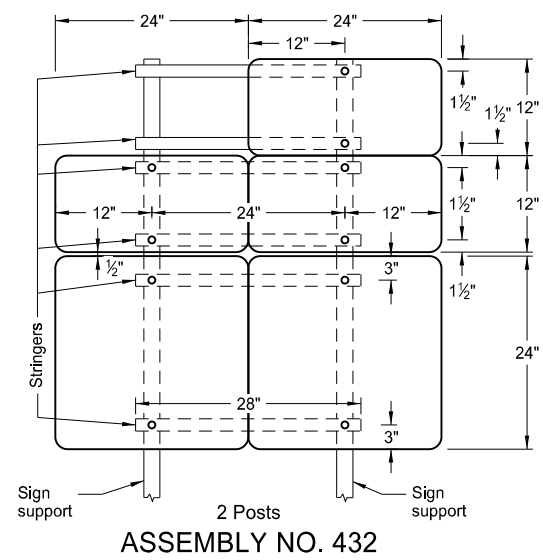
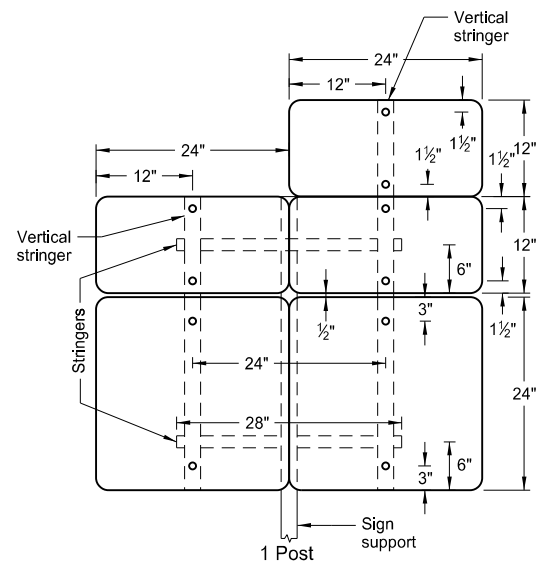

ASSEMBLY NO. 432

NORTH DAKOTA DEPARTMENT OF TRANSPORTATION	
8-22-12	
REVISIONS	
DATE	CHANGE
8-30-18	Updated to active voice & revised Assembly 432 sign spacing.
9-05-19	New Design Engineer PE Stamp.

This document was originally issued and sealed by
 Kirk J Hoff,
 Registration Number
 PE- 4683,
 on 9/05/19 and the original document is stored at the
 North Dakota Department
 of Transportation