

SIGN PUNCHING, STRINGER AND SUPPORT LOCATION DETAILS  
REGULATORY, WARNING AND GUIDE SIGNS

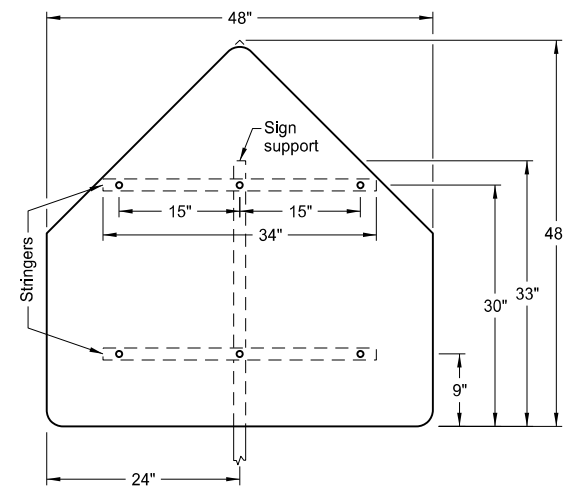

1 Post

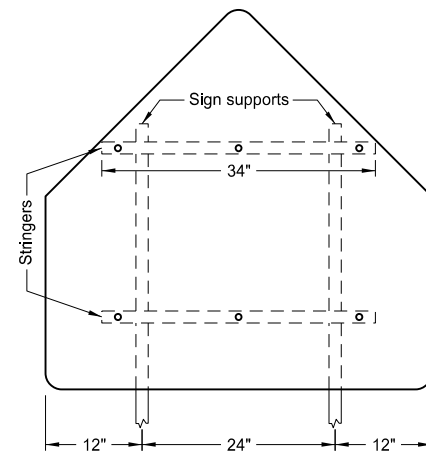

2 Posts

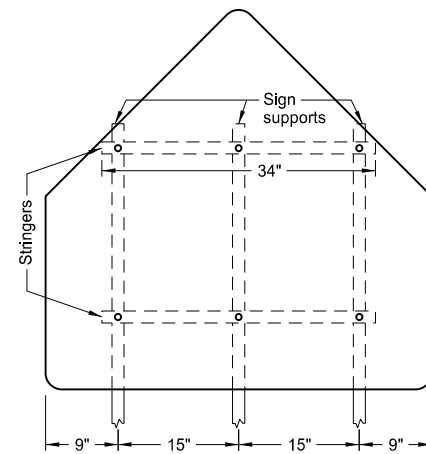

3 Posts

ASSEMBLY NO. 73

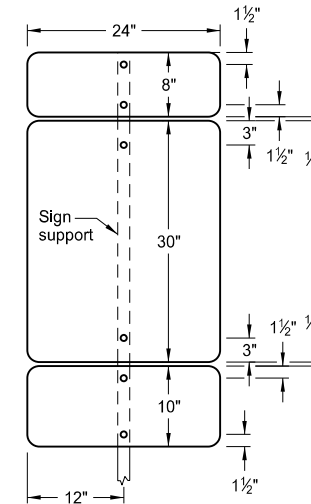

1 Post

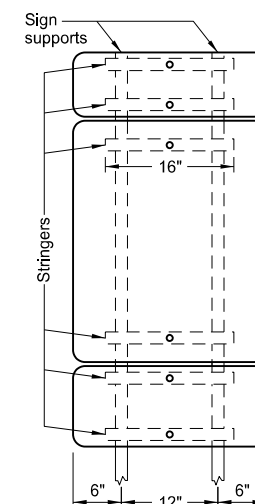

2 Posts

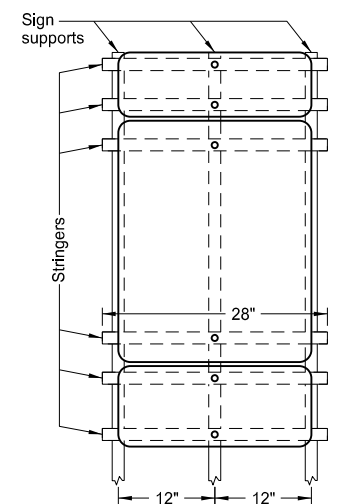

3 Posts

ASSEMBLY NO. 74

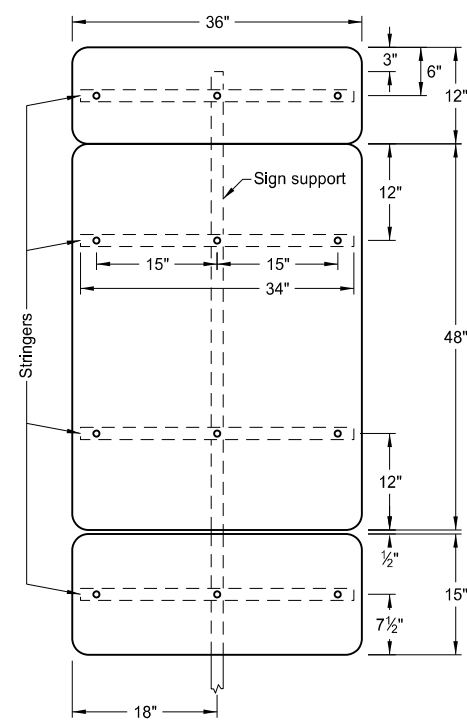

1 Post

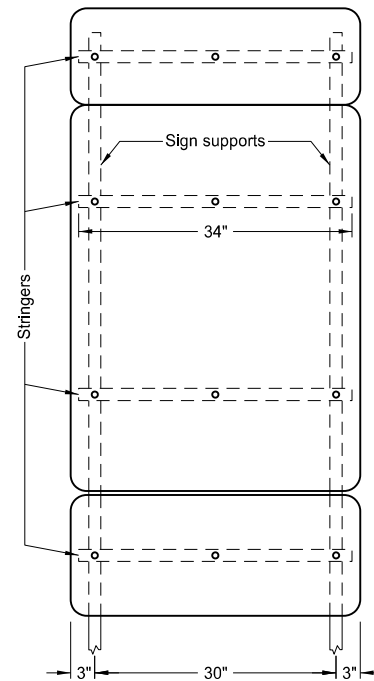

2 Posts

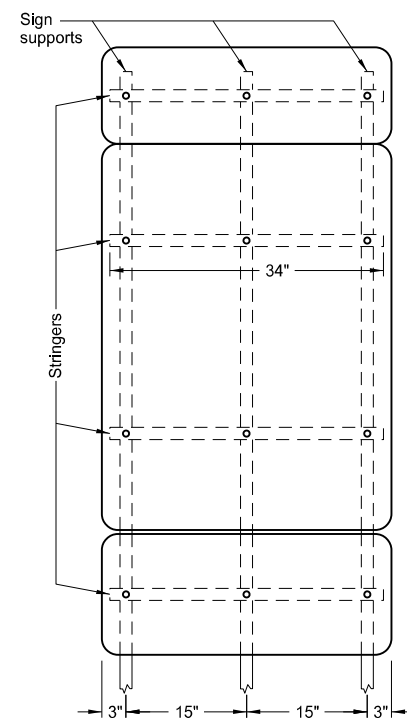

3 Posts

ASSEMBLY NO. 75

Notes:

1. Use 0.100 inch minimum thickness sign backing material.
2. Use 1 1/2"x1 1/2" perforated square tube stringers.
3. Punch holes round for 3/8" bolt.

NORTH DAKOTA DEPARTMENT OF TRANSPORTATION	
8-22-12	
REVISIONS	
DATE	CHANGE
8-30-18	Updated to active voice & removed 4 post layout for Assembly 75.
8-30-19	New Design Engineer PE Stamp.

This document was originally issued and sealed by  
Kirk J Hoff,  
Registration Number  
PE- 4683,  
on 8/30/19 and the original document is stored at the North Dakota Department of Transportation