

DESIGN DATA				
Current Traffic	Miles	Total	Design Speed	Sight Distance
CMC-3008 - CO 139A	6.39	430	45	360

PROJECT LENGTHS	MILES
CMC-3008 STA. 35+00 TO 265+69.4	4.37
CMC-3008 STA. 0+00 TO 106+68	2.02
TOTAL	6.39

MORTON COUNTY NORTH DAKOTA

FEDERAL AID PROJECT SC-3008(059) - SU-1-988(057)
MICRO-SURFACING AND INCIDENTALS
CMC-3008 FROM CROWN BUTTE EAST 6.39 MILES

STATE	PROJECT NO.	PCN	SECTION NO.	SHEET NO.
ND	SC-3008(059)	24677	1	1
ND	SU-1-988(057)	24682		

GOVERNING SPECIFICATIONS	Date published and Adopted by the North Dakota Department of Transportation
STANDARD SPECIFICATIONS	7/1/2025
SUPPLEMENTAL SPECIFICATIONS	NONE

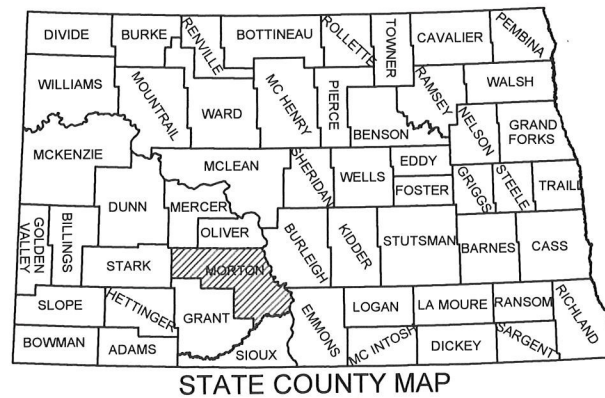
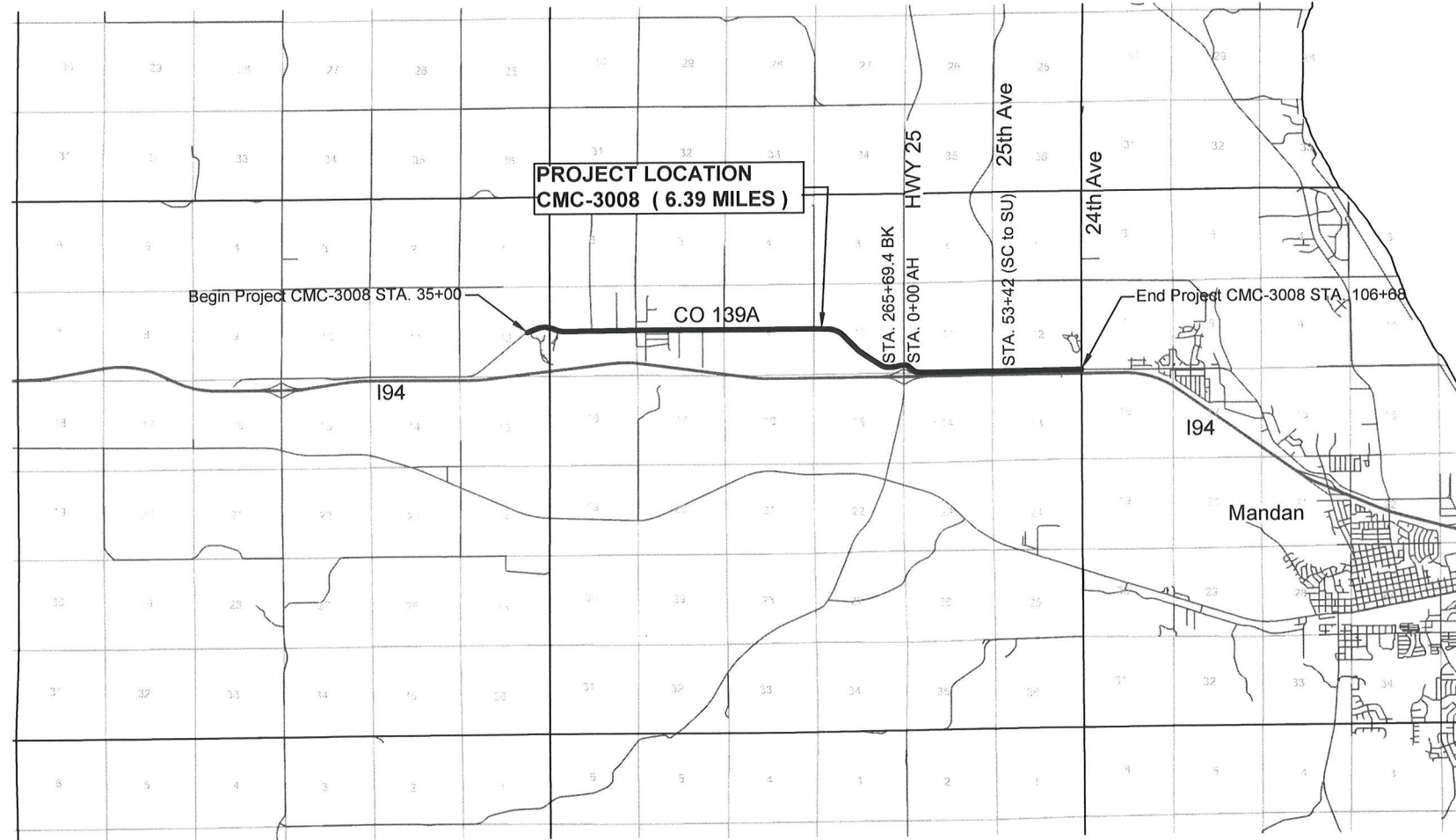

MORTON COUNTY
HIGHWAY DEPARTMENT

I hereby certify that the attached plans were prepared by me or under my direct supervision and that I am a duly registered professional engineer under the laws of the State of ND.

September 2, 2025
APPROVED DATE

John A. Saki
JOHN SAKI, P.E.
MORTON COUNTY ENGINEER

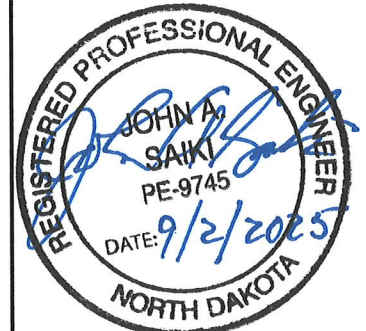

	STATE	PROJECT NO.	SECTION NO.	SHEET NO.
	ND	SC-3008(059) - SU-1-988(057)	2	1

TABLE OF CONTENTS

Section No.	Sheet No.	Description
1	1	Title Sheet
2	1	Table of Contents
4	1	Scope of Work
6	1	Notes
8	1	Quantities
10	1	Basis of Estimate
30	1	Typical Sections
100	1	Traffic Control

LIST OF STANDARD DRAWINGS

Standard No.	Description
D-101-1,2,3	NDDOT Abbreviations
D-101-10	Utility
D-101-20,21	Line Styles
D-101-30,31,32	Symbols
D-704-3	Lane Markers (Spotting Tab for Seal Projects Only)
D-704-7	Breakaway Systems for Construction Zone Signs - Perforated Tube
D-704-8	Breakaway Systems for Construction Zone Signs - U-Channel Post
D-704-9	Construction Sign Details - Terminal and Guide Signs
D-704-10	Construction Sign Details - Regulatory Signs
D-704-11	Construction Sign Details - Warning Signs
D-704-11A	Construction Sign Details - Warning Signs
D-704-13	Barricade and Channelizing Device Details
D-704-14	Construction Sign Punching and Mounting Details
D-704-15	Road Closure Layouts
D-704-20	Terminal and Seal Coat Sign Layouts
D-704-22	Construction Truck and Temporary Detour Layouts
D-704-26	Miscellaneous Sign Layouts
D-704-27	Traffic Control Plan for Moving Operations
D-704-50	Portable Sign Support Assembly
D-760-5	Saw Slotted Rumble Strips at Intersections
D-762-4	Pavement Marking
D-762-11	Short Term Pavement Marking

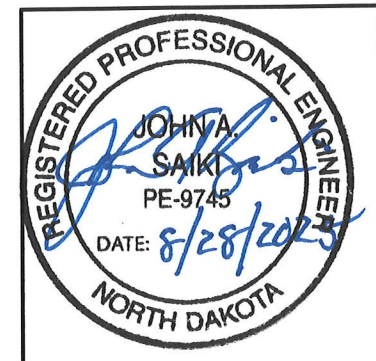
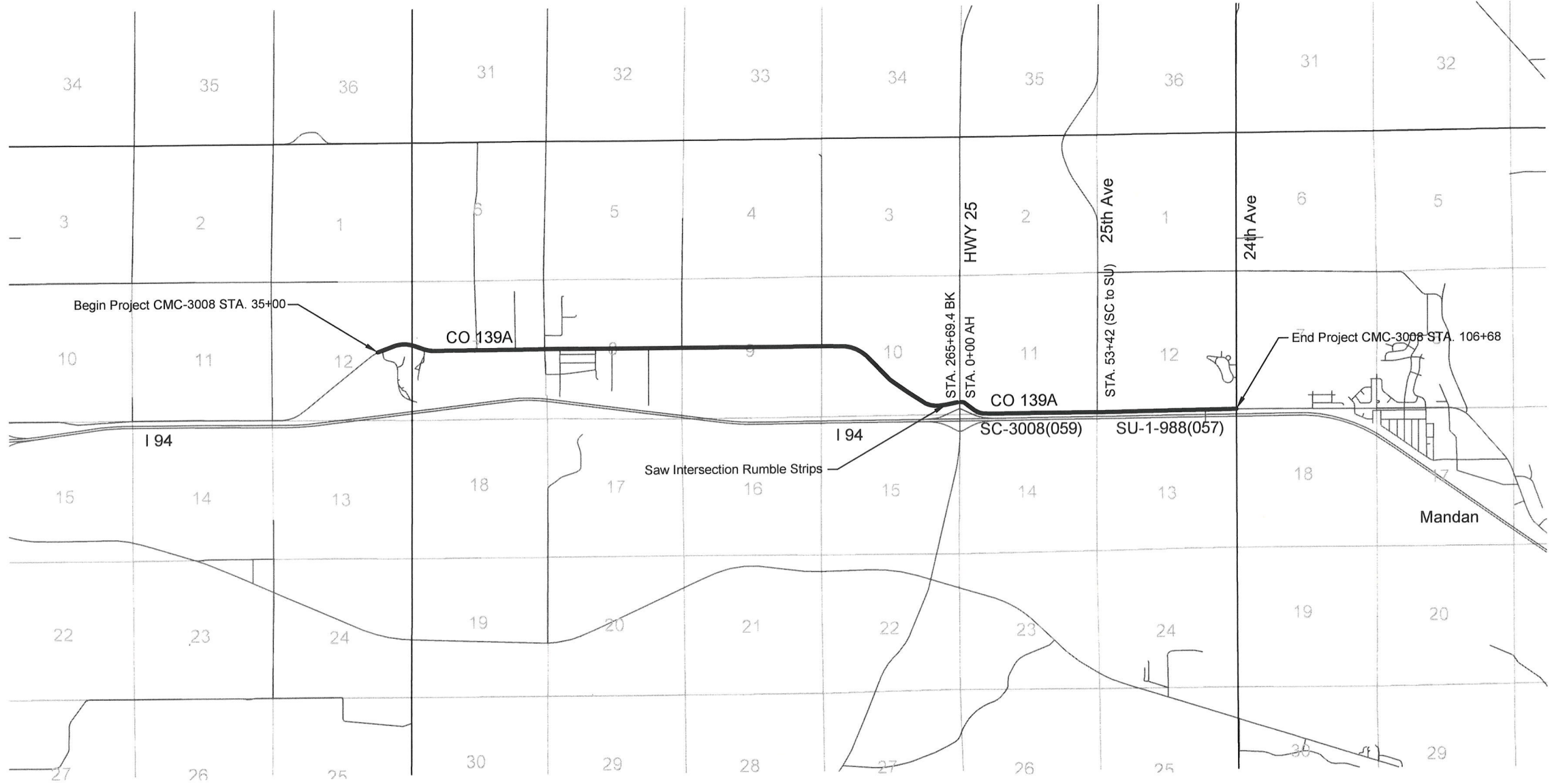
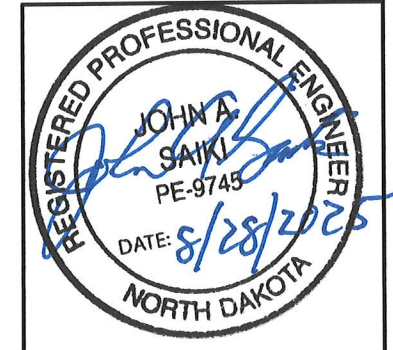

Table of Contents

STATE	PROJECT NO.	SECTION NO.	SHEET NO.
ND	SC-3008(059) - SU-1-988(057)	4	1



Micro-Surfacing Type III



Scope of Work

	STATE	PROJECT NO.	SECTION NO.	SHEET NO.
	ND	SC-3008(059) - SU-1-988(057)	6	1

NOTES

422-P01

Double Application of Micro-Surfacing: Allow the 1st lift of Micro-Surfacing to cure a minimum of 24 hours before placing 2nd lift of Micro-Surfacing.

704-P01

Traffic control for Micro-Surfacing shall consist of lane closures, flagging, and pilot car. Traffic Control Devices shall comply with the following Standard Drawings:

1. Standard D-704-15, Layout A:
2. Standard D-704-20, Layout H:
3. Standard D-704-22: For traffic control plan moving operations The required traffic control signs and devices are included in the "Traffic Control Devices List" and will be measured and paid at the contract unit price for each device. Traffic control devices will be paid one time. No additional payment will be made for moving traffic control devices during phase progression. Additional devices required to accommodate the contractor's operation shall be the contractor's responsibility.

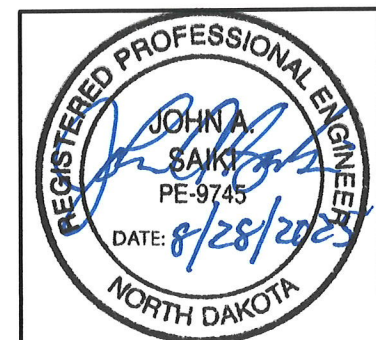

Notes

STATE	PROJECT NO.	SECTION NO.	SHEET NO.
ND	SC-3008(059) - SU-1-988(057)	8	1

ESTIMATE OF QUANTITIES

SPEC NO.	CODE NO.	ITEM	UNIT	SC-3008(059)	SU-1-988(057)	TOTAL
103	0100	CONTRACT BOND	LSUM	0.84	0.16	1
421	0011	AGGREGATE FOR MICRO-SURFACING TYPE III	TON	1283	140	1423
421	0020	ASPHALT EMULSION FOR MICRO-SURFACING	GAL	42393	4606	46999
702	0100	MOBILIZATION	LSUM	0.84	0.16	1
704	0100	FLAGGING	MHR	135	25	160
704	1000	TRAFFIC CONTROL SIGNS	UNIT	1279	128	1407
704	1185	PILOT CAR	HR	68	12	80
760	0010	RUMBLE STRIPS - INTERSECTION	SET	1	0	1
762	0430	SHORT TERM 4IN LINE - TYPE NR	LF	28824	5686	34510
762	1104	PVMT MK PAINTED 4IN LINE	LF	85197	16266	101463

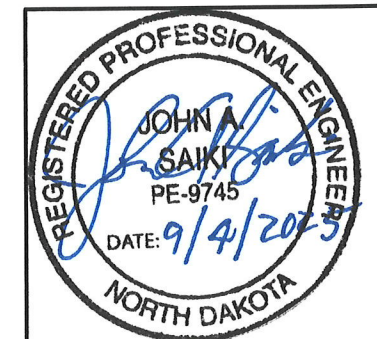

Estimate of Quantities

	STATE	PROJECT NO.	SECTION NO.	SHEET NO.
	ND	SC-3008(059) - SU-1-988(057)	10	1

BASIS OF ESTIMATE-ROADWAY

TYPICAL SECTION				
ITEM DESCRIPTION	BASIS	UNIT	WIDTH	PER MILE
AGGREGATE FOR MICRO-SURFACING TYPE III	18 LBS / SY	TON	24.5 FEET	130 TON
AGGREGATE FOR MICRO-SURFACING TYPE III	18 LBS / SY	TON	26 FEET	138 TON
ASPHALT EMULSION FOR MICRO-SURFACING @ 14% BY WEIGHT)	8.43 LBS / GAL	GAL	24.5 FEET	4297 GAL
ASPHALT EMULSION FOR MICRO-SURFACING @ 14% BY WEIGHT	8.43 LBS / GAL	GAL	26 FEET	4560 GAL

BASIS OF ESTIMATE-MARKING

<p>CENTERLINE SKIP - 4" YELLOW, 10' LINE, 30' SKIP, 1,320'/MILE CENTER LINE BARRIER LINES - 4" YELLOW, 4" BETWEEN LINES</p>
<p>PAVEMENT MARKING PAINTED LINE (PERMANENT) CENTERLINE SKIP - 4" YELLOW, 10' LINE, 30' SKIP, 1,320'/MILE CENTER LINE BARRIER LINES - 4" YELLOW, 4" BETWEEN LINES EDGE LINE - 4" WHITE, 10,560'/MILE</p>

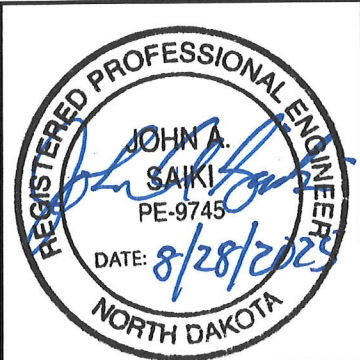

Basis of Estimate

STATE	PROJECT NO.	SECTION NO.	SHEET NO.
ND	SC-3008(059) - SU-1-988(057)	30	1

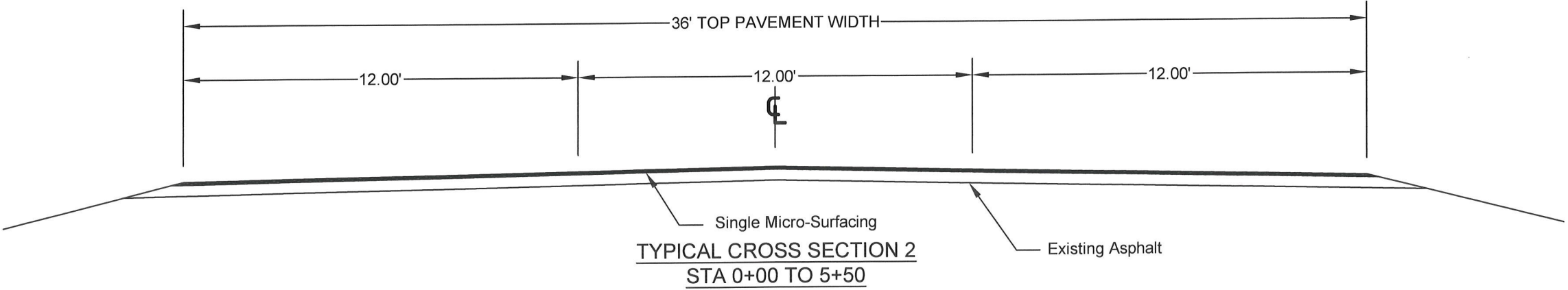
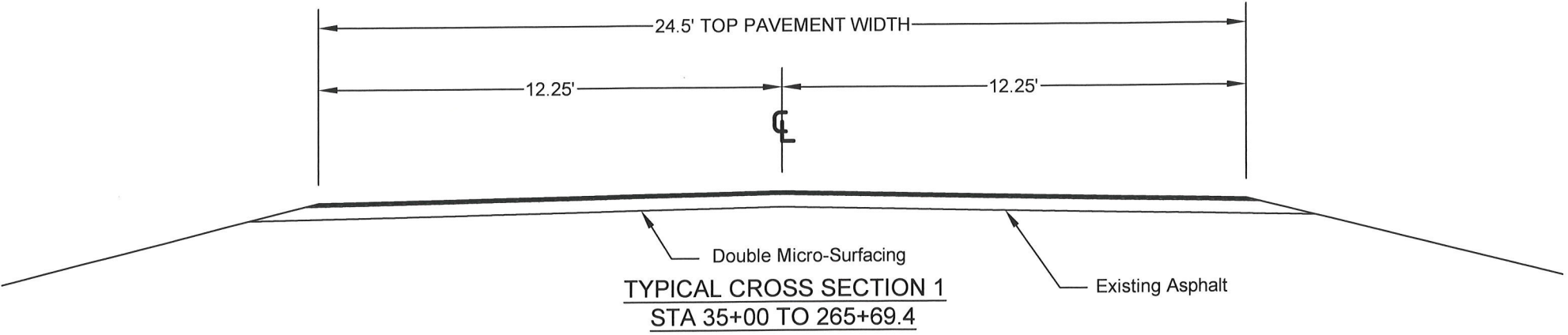

* TRANSITION AREA FROM 36' TO 26' TOP STA 5+50 TO STA11+00
 * SC-3008(059) STA 0+00 TO STA 5+50
 * SC-3008(059) STA 5+50 TO STA11+00

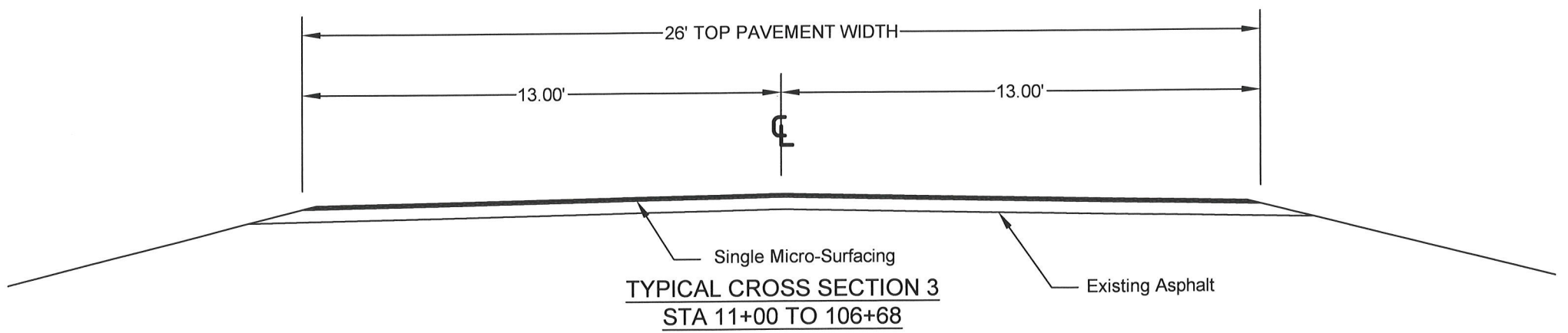

* SC-3008(059) STA 11+00 TO STA 53+42
 * SU-1-988(057) STA 53+42 TO STA 106+68

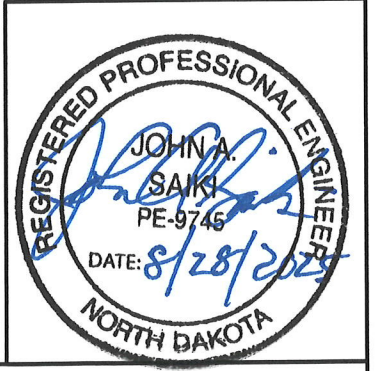

Typical Sections

STATE	PROJECT NO.	SECTION NO.	SHEET NO.
ND	SC-3008(059) - SU-1-988(057)	100	1

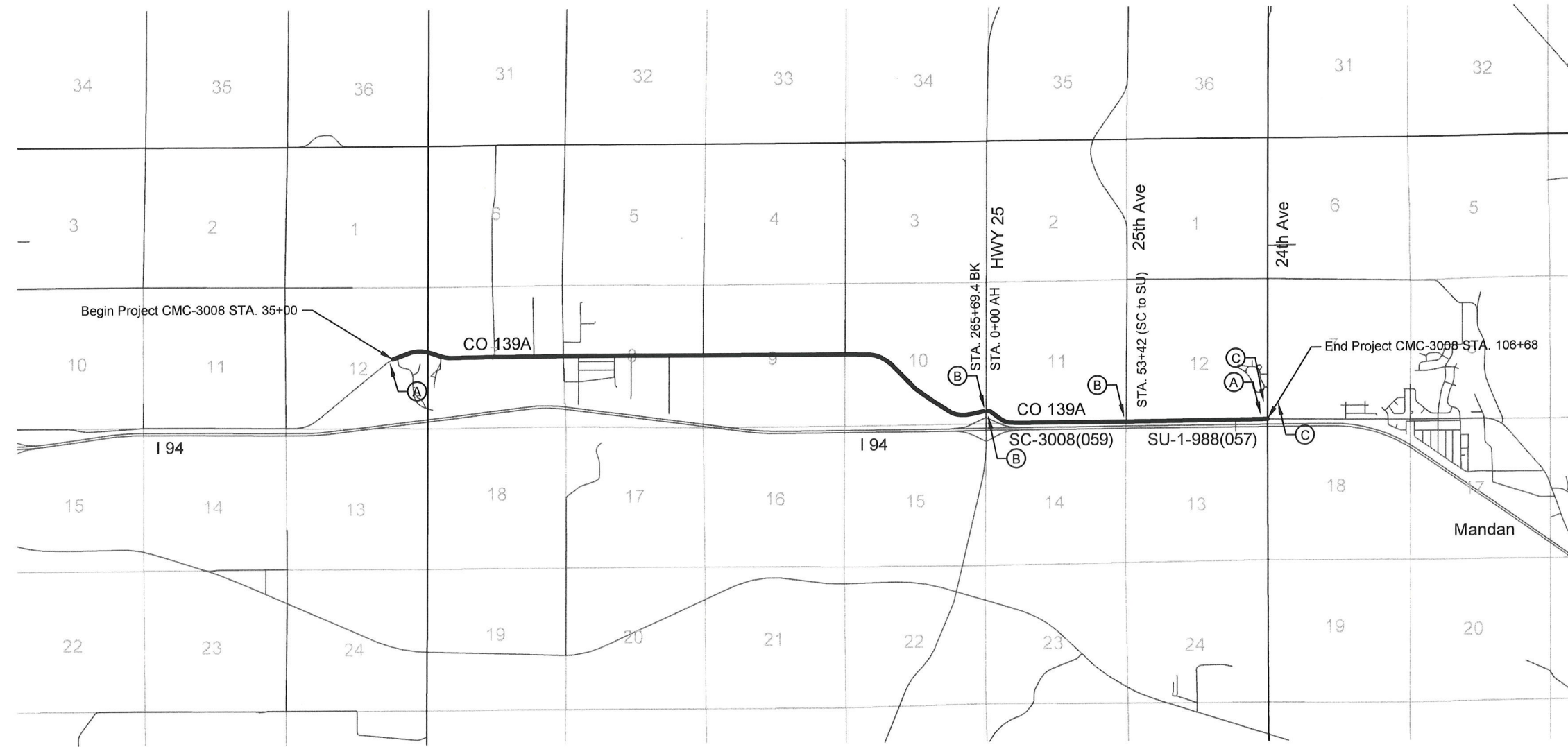

SIGN LIST						
LO.	SIGN NO	DESCRIPTION	NO.	UNITS EA	PAY FACTOR	TOTAL UNITS
(A)	G20-1-60	ROAD WORK NEXT <u>MILES</u>	2	34	1	68
(B)	G20-50a-72	ROAD WORK NEXT <u>MILES</u> RT AND LT	3	37	1	111
(C)	G20-52a-72	ROAD WORK NEXT <u>MILES</u> RT OR LT	2	30	1	60
(D)	W20-1-48	ROAD WORK AHEAD (PORTABLE)	4	35	1	140
(E)	W20-7b-48	BE PREPARED TO STOP (PORTABLE)	4	35	1	140
(F)	W20-7a-48	FLAGGING SYMBOL (PORTABLE)	4	35	1	140
(G)	W8-12-48	NO CENTER STRIPE (PORTABLE)	4	34	1	136
(H)	R4-1-48	DO NOT PASS (PORTABLE)	4	39	1	156
(I)	W3-5-48	SPEED REDUCTION AHEAD (PORTABLE)	4	35	1	140
(J)	W22-8-48	FRESH OIL LOOSE ROCK (PORTABLE)	4	35	1	140
(K)	R2-1-48	SPEED LIMIT (PORTABLE)	4	39	1	156
	R1-1-18	STOP & SLOW PADDLE BACK TO BACK	4	5	1	20
TOTAL						1407

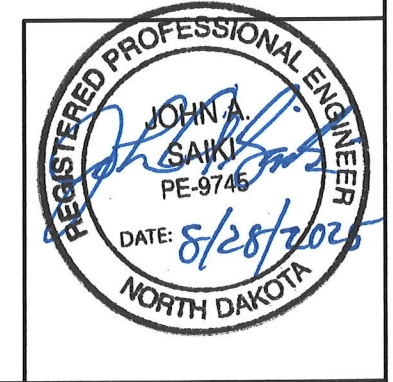

Traffic Control

NDDOT ABBREVIATIONS

? This is a special text character used in the labeling of existing features. It indicates a feature that has an unknown characteristic, potentially based on: lack of description, location accuracy or purpose.

Abn abandoned
 Abut abutment
 Adj adjusted
 Aggr aggregate
 Ahd ahead
 ARV air release valve
 Align alignment
 Al alley
 Alt alternate
 Alum aluminum
 ADA Americans with Disabilities Act
 & and
 Appr approach
 Approx approximate
 ACP asbestos cement pipe
 Asph asphalt
 AC asphalt cement
 Assmd assumed
 @ at
 Atten attenuation
 ATR automatic traffic recorder
 Ave Avenue
 Avg average
 ADT average daily traffic

C Gdrl cable guardrail
 Calc calculate
 CIP cast iron pipe
 CB catch basin
 CRS cationic rapid setting
 C Gd cattle guard
 C To C center to center
 CL or C centerline
 Ch chain
 Chnlk chain-link
 Ch Blk channel block
 Ch Ch channel change
 Chk check
 Chsld chiseled
 Cir circle
 Cl class
 Clnt clean-out
 Clr clear
 Cl&gr clearing & grubbing
 Comb. combination
 Coml commercial
 Compr compression
 CADD computer aided drafting & design
 Conc concrete
 CECB concrete erosion control blanket
 Cond conductor
 Const construction
 Cont continuous
 CSB continuous split barrel sample
 Contr contraction
 Contr contractor
 CP control point
 Coord coordinate
 Cor corner
 Corr corrected
 CAES corrugated aluminum end section
 CAP corrugated aluminum pipe
 CMES corrugated metal end section
 CMP corrugated metal pipe
 CPVCP corrugated poly-vinyl chloride pipe
 CSES corrugated steel end section
 CSFES corrugated steel flared end section
 CSP corrugated steel pipe
 CSTES corrugated steel traversable end section
 Co County
 Crse course
 Ct Court
 Xarm cross arm
 Xbuck cross buck
 Xsec cross sections
 Xing crossing
 Xrd crossroad
 Crn crown

Culv culvert
 C&G curb & gutter
 CI curb inlet
 CR curb ramp
 C cut
 Dd Ld dead load
 Defl deflection
 Defm deformed
 DInt delineate
 DIntr delineator
 Depr depression
 Desc description
 Det detail
 DWP detectable warning panel
 Dtr detour
 Dia or \emptyset diameter
 Dir direction
 Dist distance
 DM disturbed material
 DB ditch block
 DG ditch grade
 Dbl double
 Dn down
 Dwg drawing
 Dr drive
 Drwy driveway
 DI drop inlet
 D dry density
 Ea each
 Esmt easement
 E East
 EB Eastbound
 Elast elastomeric
 EL electric locker
 E Mtr electric meter
 EVSE electric vehicle supply equipment
 Elec electric/al
 EDM electronic distance meter
 Elev or El elevation
 Ellipt elliptical
 Emb embankment
 Emuls emulsion/emulsified
 ES end section
 Engr engineer
 ESS environmental sensor station
 Eq equal
 Evgr evergreen
 Exc excavation
 Exst existing
 Exp expansion
 Expy Expressway
 E external of curve
 Extru extruded

FOS factor of safety
 Fed Federal
 FP feed point
 Fn fence
 Fn P fence post
 FO fiber optic
 FD field drive
 F fill
 FAA fine aggregate angularity
 FH fire hydrant
 Fl flange
 Flrd flared
 FES flared end section
 F Bcn flashing beacon
 FA flight auger sample
 FL flow line
 Ftg footing
 FM force main
 Fnd found
 Fdn foundation
 Frac fractional
 Frwy freeway
 Frt front
 FF front face
 F Disp fuel dispenser
 FFP fuel filler pipes
 FLS fuel leak sensor
 Furn furnish/ed

Bk back
 BF back face
 Balc balcony
 B Wire barbed wire
 Barr barricade
 Btry battery
 BI beehive inlet
 Beg begin
 BG below grade
 BM bench mark
 Bkwy bikeway
 Bit bituminous
 Blk block
 BH bore hole
 Bot bottom
 Blvd Boulevard
 Bndry boundary
 Brkwy breakaway
 Br bridge
 Bldg building
 Bus. business
 BV butterfly valve
 Byp bypass

NORTH DAKOTA DEPARTMENT OF TRANSPORTATION	
07-01-14	
REVISIONS	
DATE	CHANGE
04-23-18	General Revisions
09-20-18	General Revisions
12-18-20	General Revisions
08-16-22	General Revisions
04-14-25	General Revisions



NDDOT ABBREVIATIONS

D-101-2

Galv	galvanized	Ln	lane	Obsc	obscure(d)	Qty	quantity
Gar	garage	Lg	large	Ocpd	occupied	Qtr	quarter
Gs L	gas line	Lat	latitude	Ocpy	occupy		
G Reg	gas line regulator	Lt	left	O/s	offset		
GMV	gas main valve	Lens	lenses	OC	on center	Rad or R	radius
G Mtr	gas meter	Lvl	level	C	one dimensional consolidation	RR	railroad
GSV	gas service valve	Lvng	leveling	OC	organic content	Rlwy	railway
GVP	gas vent pipe	Lht	light	Orig	original	Rsd	raised
GV	gate valve	LP	light pole	O To O	out to out	RC	rapid curing
Ga	gauge	Ltg	lighting	OD	outside diameter	Rec	record
Gov	government	Liq	liquid	OH	overhead	Recy	recycle
Grd	graded/grade	LL	liquid limit			RAP	recycled asphalt pavement
Grnd	ground	Loc	location			RPCC	recycled portland cement concrete
GWM	ground water monitor	Long.	longitude	PMT	pad mounted transformer	Ref	reference
Gdrl	guardrail	Lp	loop	Pg	pages	R Mkr	reference marker
Gtr	gutter	LD	loop detector	Pntd	painted	RM	reference monument
		Lum	luminaire	Pr	pair	RP	reference point
				Pnl	panel	Refl	reflectorized
H Plg	H piling			Pk	park	RCB	reinforced concrete box
Hdwl	headwall	Mb	mailbox	PSD	passing sight distance	RCES	reinforced concrete end section
Ht	height	ML	main line	Pvmt	pavement	RCFES	reinforced concrete flared end section
Hel	helical	MH	manhole	Ped	pedestal	RCP	reinforced concrete pipe
HDPE	high density polyethylene	Mkd	marked	Ped	pedestrian	RCPS	reinforced concrete pipe sewer
HM	high mast	Mkr	marker	PPP	pedestrian pushbutton post	RCTES	reinforced concrete traversable end section
HP	high pressure	Mkg	marking	Pen.	penetration	Reinf	reinforcement
HPS	high pressure sodium	MA	mast arm	Perf	perforated	Res	reservation
HTCG	high tension cable guardrail	Matl	material	Per.	perimeter	Res	residence
Hwy	highway	Max	maximum	Perm	permanent	Ret	retaining
Hor	horizontal			PL	pipeline	Rev	reverse
HBP	hot bituminous pavement	Meas	measure	PI	place	Rt	right
HMA	hot mix asphalt	Mdn	median	P&P	plan & profile	R/W	right of way
Hyd	hydrant	MD	median drain	PL	plastic limit	Riv	river
Ph	hydrogen ion content	MC	medium curing	Pl or \bar{P}	plate	Rd	road
		MGS	Midwest Guardrail System	Pt	point	Rdbd	road bed
		MM	mile marker	PE	polyethylene	Rdwy	roadway
Id	identification	MP	mile post	PVC	polyvinyl chloride	RWIS	roadway weather information system
Incl	inclinometer tube	Min	minimum	PCC	Portland Cement concrete	Rk	rock
IMH	inlet manhole	Misc	miscellaneous	PP	power pole	Rt	route
ID	inside diameter	Mon	monument	Preempt	preemption		
Inst	instrument	Mnd	mound	Prefab	prefabricated		
Intchg	interchange	Mtbl	mountable	Prfmd or Pref	performed		
Intmdt	intermediate	Mtd	mounted	Prep	preparation		
Intscn	intersection	Mtg	mounting	Press.	pressure		
Inv	invert	Mk	muck	PRV	pressure relief valve		
IP	iron pipe			Prestr	prestressed		
				Pvt	private		
				PD	private drive		
Jt	joint	Neop	neoprene	Prod.	production/produce		
Jct	junction	Ntwk	network	Prog	programmed		
		N	North	Prop.	property		
		NE	Northeast	Ppsd	proposed		
		NW	Northwest	PB	pull box		
		NB	Northbound				
		No. or #	number				

NORTH DAKOTA DEPARTMENT OF TRANSPORTATION	
07-01-14	
REVISIONS	
DATE	CHANGE
08-03-15	General Revisions
04-23-18	General Revisions
12-18-20	General Revisions
08-16-22	General Revisions
04-14-25	General Revisions

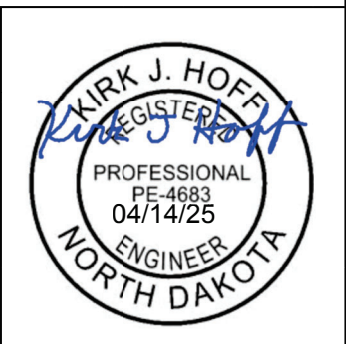

NDDOT ABBREVIATIONS

D-101-3

Salv	salvage(d)	Tel	telephone
San	sanitary sewer line	Tel B	Telephone Booth
Sec	section	Tel P	telephone pole
SL	section line	Tv	television
Sep	separation	Temp	temperature
Seq	sequence	Temp	temporary
Serv	service	TBM	temporary bench mark
Sht	sheet	T	thinwall tube sample
Shtng	sheeting	Ts	topsoil
Shldr	shoulder	Traf	traffic
Sw or Sdwk	sidewalk	TSCB	traffic signal control box
SD	sight distance	Tr	trail
SN	sign number	Transf	transformer
Sig	signal	Trans	transition
Sgl	single	TT	transmission tower
SRCP	slotted reinforced concrete pipe	TES	traversable end section
SC	slow curing	Trans	transverse
SS	slow setting	Trtd	treated
Sm	small	Trmt	treatment
S	South	Qc	triaxial compression
SE	Southeast	TERO	tribal employment rights ordinance
SW	Southwest	Tpl	triple
SB	Southbound	Typ	typical
Sp	spaces		
Spcl	special	Qu	unconfined compressive strength
SA	special assembly	Ugrnd	underground
SP	special provisions	Util	utility
G	specific gravity		
Spk	spike	VG	valley gutter
SB	split barrel sample	Vap	vapor
SH	sprinkler head	Vert	vertical
SV	sprinkler valve	VCP	vitrified clay pipe
Sq	square	Vol	volume
Stk	stake	VSFS	vehicle speed feedback sign
Std	standard		
N	standard penetration test	Wkwy	walkway
Std Specs	standard specifications	W	water content
Stm L	steam line	WGV	water gate valve
SEC	steel encased concrete	WL	water line
SMA	stone matrix asphalt	WM	water main
SSD	stopping sight distance	WMV	water main valve
SD	storm drain	W Mtr	water meter
St	street	WSV	water service valve
SPP	structural plate pipe	WW	water well
SPPA	structural plate pipe arch	Wrng	wearing
Str	structure	WIM	weigh in motion
Subd	subdivision	W	west
Sub	subgrade	WB	westbound
Sub Prep	subgrade preparation	Wrng	wiring
Ss	subsoil	W/	with
SS	supplement specification	W/o	without
Supp	supplemental		
Surf	surfacing		
Surv	survey		
Sym	symmetrical		

NORTH DAKOTA
DEPARTMENT OF TRANSPORTATION

07-01-14

REVISIONS

DATE	CHANGE
08-03-15	General Revisions
04-23-18	General Revisions
12-18-20	General Revisions
08-16-22	General Revisions
04-14-25	General Revisions

08-03-15 General Revisions
04-23-18 General Revisions
12-18-20 General Revisions
08-16-22 General Revisions
04-14-25 General Revisions



NDDOT UTILITY COMPANY AND ORGANIZATION ABBREVIATIONS

D-101-10

702COM 702 Communications
 ACCENT Accent Communications
 AGASSIZ WU Agassiz Water Users District
 AGC Associated General Contractors of America
 ALL PL Alliance Pipeline
 ALL SEAS WU All Seasons Water Users District
 AMOCO PI Amoco Pipeline Company
 AMRDA HESS Amerada Hess Corporation
 AT&T AT&T Corporation
 B PAW Bear Paw Energy Incorporated
 BAKER ELEC Baker Electric
 BASIN ELEC Basin Electric Cooperative Incorporated
 BEK TEL Bek Communications Cooperative
 BELLE PL Belle Fourche Pipeline Company
 BLM Bureau of Land Management
 BNSF Burlington Northern Santa Fe Railway
 BOEING Boeing
 BRNS RWD Barnes Rural Water District
 BURK-DIV ELEC Burke-Divide Electric Cooperative
 BURL WRD Burleigh County Water Resource District
 CABLE ONE Cable One
 CABLE SERV Cable Services
 CAP ELEC Capital Electric Cooperative Incorporated
 CASS CO ELEC Cass County Electric Cooperative
 CASS RWU Cass Rural Water Users District
 CAV ELEC Cavalier Rural Electric Cooperative
 CBLCOM Cablecom Of Fargo
 CENEX PL Cenex Pipeline
 CENT PL WATER DIST Central Pipe Line Water District
 CENT PWR ELEC Central Power Electric Cooperative
 CENTURYLINK CenturyLink
 COE Corps of Engineers
 CONS COMM Consolidated Communications
 CONS TELCOM Consolidated Telcom
 CONT RES Continental Resource Inc
 CPR Canadian Pacific Railway
 D O E Department Of Energy
 DAK CARR Dakota Carrier Network
 DAK CENT TEL Dakota Central Telephone
 DAK RWD Dakota Rural Water District
 DGC Dakota Gasification Company
 DICKEY R NET Dickey Rural Networks
 DICKEY WRD Dickey County Water Resource District
 DICKEY TEL Dickey Telephone
 DNRR Dakota Northern Railroad
 DOME PL Dome Pipeline Company
 DVELEC Dakota Valley Electric Cooperative
 DVMW Dakota, Missouri Valley & Western
 E CENT REG WD East Central Water District
 ENBRDG Enbridge Pipelines Incorporated
 ENVENTIS Enventis Telephone
 EQUINOR Equinor Pipeline
 FALK MNG Falkirk Mining Company
 FHWA Federal Highway Administration
 G FKS-TRL WD Grand Forks-traill Water District
 GETTY TRD & TRAN Getty Trading & Transportation
 GLDN W ELEC Golden West Electric Cooperative

GTR RAMSEY WD Greater Ramsey Water District
 GT PLNS NAT GAS Great Plains Natural Gas Company
 HALS TEL Halstad Telephone Company
 IDEA1 Idea1
 INT-COMM TEL Inter-Community Telephone Company
 KANEB PL Kaneb Pipeline Company
 KEM ELEC Kem Electric Cooperative Incorporated
 KOCH GATH SYS Koch Gathering Systems Incorporated
 LKHD PL Lakehead Pipeline Company
 LWR YELL R ELEC Lower Yellowstone Rural Electric
 LUMEN Lumen Technologies Incorporated
 MCKNZ CON McKenzie Consolidated Telcom
 MCKNZ ELEC McKenzie Electric Cooperative
 MCKNZ WRD McKenzie County Water Resource District
 MCLEOD McLeod USA
 MCLN ELEC McLean Electric Cooperative
 MCLN-SHRDN R WAT McLean-Sheridan Rural Water District
 MDU Montana-dakota Utilities
 MIDCO MidContinent Communications
 MIDSTATE TEL Midstate Telephone Company
 MINOT CABLE Minot Cable Television
 MINOT TEL Minot Telephone Company
 MISS VALL COMM Missouri Valley Communications Incorporated
 MISS W W S Missouri West Water System
 MNKOTA PWR Minnkota Power
 MOR-GRAN-SOU ELEC Mor-gran-sou Electric Cooperative
 MOUNT-WILLI ELEC Mountrail-williams Electric Cooperative
 MLGC Moore & Liberty - Griggs County
 MUNICIPAL City Water And Sewer
 MUNICIPAL City Of '.....'
 N CENT ELEC North Central Electric Cooperative
 N PRAIR REG WD North Prairie Regional Water District
 ND PKS & REC North Dakota Parks And Recreation
 ND TEL North Dakota Telephone Company
 NDDOT North Dakota Department of Transportation
 NE REG WD Northeast Regional Water District
 NDSU SOIL SCI DEPT NDSU Soil Science Department
 NEMONT TEL Nemont Telephone
 NODAK R ELEC Nodak Rural Electric Cooperative
 NOON FRMS TEL Noonan Farmers Telephone Company
 NPR Northern Plains Railroad
 NSP Northern States Power
 NTHN BRDR PL Northern Border Pipeline
 NTHN PLNS ELEC Northern Plains Electric Cooperative Incorporated
 NTHWSTRN REF Northwestern Refinery Company
 NW COMM Northwest Communication Cooperation
 NWRWD Northwest Rural Water District
 ONEOK Oneok gas
 OSHA Occupational Safety and Health Administration
 OTTR TL PWR Otter Tail Power Company
 PAAP Plains All American Pipeline
 P L E M Prairielands Energy Marketing
 POLAR COM Polar Communications
 PVT ELEC Private Electric
 QWEST Qwest Communications
 R&T REG WD R & T Water District

RED RIV COMM Red River Communications
 RESVTN TEL Reservation Telephone
 ROBRTS TEL Roberts Company Telephone
 R-RIDER ELEC Roughrider Electric Cooperative
 RRVW Red River Valley & Western Railroad
 S CENT REG WD South Central Regional Water District
 SE W U Southeast Water Users Incorporated
 SCOTT CABLE Scott Cable Television Dickinson
 SHERDN ELEC Sheridan Electric Cooperative
 SHEYN VLY ELEC Sheyenne Valley Electric Cooperative
 SKYTECH Skyland Technologies Incorporated
 SLOPE ELEC Slope Electric Cooperative Incorporated
 SOURIS RIV TELCOM Souris River Telecommunications
 ST WAT COMM State Water Commission
 STATE LN WATER State Line Water Cooperative
 STER ENG Sterling Energy
 STUT RWD Stutsman Rural Water District
 SW PL PRJ Southwest Pipeline Project
 SWWA Southwest Water Authority
 SUNOCO Sunoco LP
 T M C Turtle Mountain Communications
 TCI TCI of North Dakota
 TESORO HGH PLNS PL Tesoro High Plains Pipeline
 TRI-CNTY WU Tri-County Water Users Incorporated
 TRL CO WRD Traill County Water Resource District
 UNTD TEL United Telephone
 UPPR SOUR WD Upper Souris Water District
 US SPRINT U.S. Sprint
 USAF MSL CABLE U.S.A.F. Missile Cable
 USFWS US Fish and Wildlife Service
 USW COMM U.S. West Communications
 VRNDRY ELEC Verendrye Electric Cooperative
 W RIV TEL West River Telephone Incorporated
 WAPA Western Area Power Administration
 WAWSA Western Area Water Supply Authority
 WEB W. E. B. Water Development Association
 WILLI WRD Williams County Water Resource District
 WILSTN BAS PL Williston Basin Interstate Pipeline Company
 WLSH RWD Walsh Water Rural Water District
 WOLVRTN TEL Wolverton Telephone
 XLENER Xcel Energy
 YSVR Yellowstone Valley Railroad

NORTH DAKOTA DEPARTMENT OF TRANSPORTATION	
07-01-14	
REVISIONS	
DATE	CHANGE
04-23-18	General Revisions
05-20-18	General Revisions
12-18-20	General Revisions
08-16-22	General Revisions
04-14-25	General Revisions



LINE STYLES

D-101-20

Existing Topography

- Void — Void — Void — V Existing Ground Void
- + — + — Existing Cemetary Boundary
- - - - - Existing Box Culvert Bridge
- - - - - Existing Concrete Surface
- - - - - Existing Drainage Structure
- — — — — Existing Gravel Surface
- — — — — Existing Riprap
- — — — — Existing Dirt Surface
- — — — — Existing Asphalt Surface
- — — — — Existing Tie Point Line
- - - - - Existing Railroad Centerline
- . - . - . Existing Guardrail Cable
- • — • — • Existing Guardrail Metal
- . — . — . Existing Edge of Water
- - - - -x- - - - -x- Existing Fence
- | | | | | Existing Railroad
- Existing Field Line
- ~ ~ ~ ~ ~ Exst Flow
- ===== Existing Curb
- - - - - Existing Valley Gutter
- - - - - Existing Driveway Gutter
- ===== Existing Curb and Gutter
- ===== Existing Mountable Curb and Gutter

- - - - - Existing 3-Cable w Posts
- — — — — Site Boundary
- Existing Berm, Dike, Pit, or Earth Dam
- Existing Ditch Block
- ~ ~ ~ ~ ~ Existing Tree Boundary
- ===== Existing Brush or Shrub Boundary
- Existing Retaining Wall
- — — — — Existing Planter or Wall
- — — — — Existing W-Beam Guardrail with Posts
- — — — — Existing Railroad Switch
- ~ ~ ~ ~ ~ Gravel Pit - Borrow Area
- - - - - Existing Wet Area-Vegetation Break
- - - - - Existing High Tension Cable Guardrail
- - - - - Existing High Tension Cable Guardrail with Posts

Proposed Topography

- — — — — 3-Cable w Posts
- ~ ~ ~ ~ ~ Flow
- x- - - -x- - - -x- Fence
- REMOVE — REMOVE — Remove Line
- ===== Wall
- ~ ~ ~ ~ ~ Retaining Wall (Plan View)
- — — — — W-Beam w Posts
- — — — — High Tension Cable Guardrail with Posts

Existing Utilities

- — — — — E — Existing Electrical
- — — — — FO — Existing Fiber Optic Line
- — — — — FO — Existing TV Fiber Optic
- — — — — G — Existing Gas Pipe
- — — — — OH — Existing Overhead Utility Line
- — — — — P — Existing Power
- — — — — PL — Existing Fuel Pipeline
- — — — — PL — Existing Undefined Above Ground Pipe Line
- - - - - SAN - - - - - Existing Sanitary Sewer
- - - - - SAN FM - - - - - Existing Sanitary Force Main
- - - - - SD - - - - - Existing Storm Drain
- - - - - SD FM - - - - - Existing Storm Drain Force Main
- - - - - Existing Culvert
- — — — — T — Existing Telephone Line
- — — — — TV — Existing TV Line
- — — — — W — Existing Water or Steam Line
- ===== Existing Under Drain
- ===== Existing Slotted Drain
- — — — — Existing Conduit
- - - - - Existing Conductor
- — — — — Existing Down Guy Wire Down Guy
- — — — — Existing Underground Vault or Lift Station

Proposed Utilities

- ===== 24 Inch Pipe
- ===== Reinforced Concrete Pipe
- ===== Under Drain
- - - - - Edge Drain

Traffic Utilities

- - - - - Conductor
- - - - - Fiber Optic
- - - - - Existing Loop Detector
- — — — — Existing Double Micro Loop Detector
- — — — — Micro Loop Detector Double
- — — — — Existing Micro Loop Detector
- — — — — Micro Loop Detector
- ↓ — — — — Signal Head with Mast Arm
- ↓ — — — — Existing Signal Head with Mast Arm

Sign Structures

- — — — — Existing Overhead Sign Structure
- — — — — Existing Overhead Sign Structure Cantilever
- — — — — Overhead Sign Structure Cantilever

NORTH DAKOTA DEPARTMENT OF TRANSPORTATION	
07-01-14	
REVISIONS	
DATE	CHANGE
09-23-16	Added and Revised Items, Organized by Functional Groups
12-18-20	General Revisions

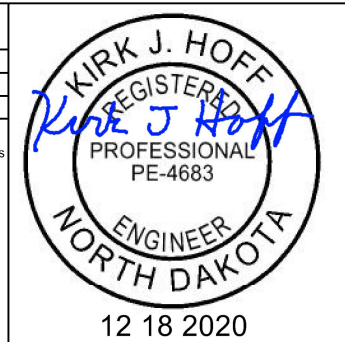

LINE STYLES

D-101-21

Right Of Way

- Easement
- Existing Easement
- Right of Way
- Existing Right of Way
- Existing Right of Way Railroad
- Existing Right of Way Not State Owned
- Existing Government Lot Line
- Existing Adjacent Block Lines
- Existing Adjacent Lot Lines
- Existing Adjacent Property Line
- Existing Adjacent Subdivision Lines
- Sight Distance Triangle Line
- Dimension Leader

Boundary Control

- ////// Existing City Corporate Limits or Reservation Boundary
- Existing State or International Line
- Existing Township
- Existing County
- Existing Section Line
- Existing Quarter Section Line
- Existing Sixteenth Section Line
- Existing Centerline
- Tangent Line

Cross Sections and Typical

- Existing Ground
- Existing Topsoil (Cross Section View)
- void - void - void - v Existing Ground Void (Not Surveyed)
- Existing Concrete
- Existing Aggregate (Cross Section View)
- Existing Curb and Gutter (Cross Section View)
- Existing Asphalt (Cross Section View)
- Existing Reinforcement Rebar

Geotechnical

- D ----- D ----- Geotextile Fabric Type D
- **Geo** ----- **Geo** ----- Geogrid
- R ----- R ----- Geotextile Fabric Type R
- R ----- R ----- Geotextile Fabric Type R1
- RR ----- RR ----- Geotextile Fabric Type RR
- S ----- S ----- Geotextile Fabric Type S

Countours

- Depression Contours
- Supplemental Contour

Profile

- Subgrade, Subcut or Ditch Grade
- Topsoil Profile

Striping

- Centerline Pavement Marking
- ===== Barrier with Centerline Pavement Marking
- ===== Barrier Pavement Marking
- - - - - Stripe 4 IN Dotted Extension White
- - - - - Stripe 8 IN Dotted Extension White
- - - - - Stripe 8 IN Lane Drop

Pavement Joints

- ===== Doweled Joint
- +++++ Tie Bar 30 Inch 4 Foot Center to Center
- +++++ Tie Bar 18 Inch 3 Foot Center to Center
- +++++ Tie Bar at Random Spacing

Bridge Details

- Small Hidden Object
- Large Hidden Object
- Phantom Object
- Existing Conditions Object
- Centerline Main
- Centerline Secondary
- Excavation Limits
- Proposed Ground
- Sheet Piling

Erosion Control

- Limits of Const Transition Line
- Bale Check
- Rock Check
- s ----- s ----- Floating Silt Curtain
- SF ----- SF ----- Silt Fence
- Excavation Limits
- Fiber Rolls

Environmental

- Wetland Mitigation
- Existing Wetland Easement USFWS
- Existing Wetland Jurisdictional
- Existing Wetland
- Tree Row

NORTH DAKOTA DEPARTMENT OF TRANSPORTATION	
07-01-14	
REVISIONS	
DATE	CHANGE
09-23-16	Added and Revised Items, Organized by Functional Groups General Revisions
12-18-20	

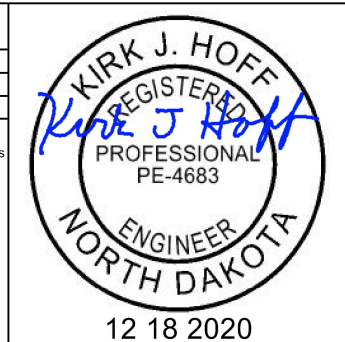

SYMBOLS



North Arrow (Half Scale)



Alignment Data Point



Alignment Monument



Spot Elevation



Existing Miscellaneous Spot



Existing Access Control Arrow



Existing Benchmark



Reset USGS Marker



Iron Monument Found



Iron Pin R/W Monument



Property Corner



Iron Pin Reference Monument



Right of Way Marker (Exst, Ppsd, Reset)



Existing Federal Reference Corner



Existing Section Corner (Full, Quarter, Sixteenth, Meander)



Existing Witness Corner



Existing Control Point (CP, GPS-RTK, TRI)



Existing Traverse PI Aerial Panel



Existing Reference Marker Point NGS



Existing EFB Misc



Existing Bush or Shrub



Existing Large Evergreen Tree



Existing Small Evergreen Tree



Existing Large Tree



Existing Small Tree



Existing Tree Trunk

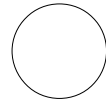

Cairn or Stone Circle



Existing Artifact



Existing Satellite Dish



Existing Weather Station



Existing Windmill or Tower



Reinforced Pavement



Continuous Split Barrel Sample



Flight Auger Sample



Split Barrel Sample



Thinwall Tube Sample



Standard Penetration Test



Inclinometer Tube



Excavation Unit









































































Existing Ground Water Well Bore Hole

NORTH DAKOTA DEPARTMENT OF TRANSPORTATION	
07-01-14	
REVISIONS	
DATE	CHANGE
12-18-20	General Revisions

Professional Engineer Seal for Kirk J. Hoff, North Dakota, PE-4683, dated 12 18 2020.

SYMBOLS

D-101-32

 Existing Luminaire  Luminaire LED  Existing Light Standard Luminaire  Relocate Light Standard  Light Standard Light LED Luminaire  Light Standard 35 Watt High Pressure Sodium Vapor Luminaire  Light Standard 50 Watt High Pressure Sodium Vapor Luminaire  Light Standard 70 Watt High Pressure Sodium Vapor Luminaire  Light Standard 100 Watt High Pressure Sodium Vapor Luminaire  Light Standard 150 Watt High Pressure Sodium Vapor Luminaire  Light Standard 200 Watt High Pressure Sodium Vapor Luminaire  Light Standard 250 Watt High Pressure Sodium Vapor Luminaire  Light Standard 310 Watt High Pressure Sodium Vapor Luminaire  Light Standard 400 Watt High Pressure Sodium Vapor Luminaire  Light Standard 700 Watt High Pressure Sodium Vapor Luminaire  Light Standard 1000 Watt High Pressure Sodium Vapor Luminaire  Emergency Vehicle Detector  Video Detection Camera	  High Mast Light Standard 3 Luminaire (Exst, Ppsd)   High Mast Light Standard 4 Luminaire (Exst, Ppsd)   High Mast Light Standard 5 Luminaire (Exst, Ppsd)   High Mast Light Standard 6 Luminaire (Exst, Ppsd)   High Mast Light Standard 7 Luminaire (Exst, Ppsd)   High Mast Light Standard 8 Luminaire (Exst, Ppsd)   High Mast Light Standard 9 Luminaire (Exst, Ppsd)   High Mast Light Standard 10 Luminaire (Exst, Ppsd)  Overhead Sign Structure Load Center (Exst, Ppsd)  Traffic Signal Controller (Exst, Ppsd)  Pad Mounted Traffic Signal Controller (Exst, Ppsd)  Flashing Beacon (Exst, Ppsd)  Concrete Foundation (Exst, Ppsd)  Pipe Mounted Flasher (Exst, Ppsd)  Pad Mounted Feed Point (Exst, Ppsd)  Pipe Mounted Feed Point with Pad (Exst, Ppsd)  Pole Mounted Feed Point (Exst, Ppsd)  Junction Box (Exst, Ppsd)  Existing Pedestrian Head with Number  Existing Signal Head  Pole Mounted Head  Existing Lighting Standard Pole	 Existing Traffic Signal Standard    Pull Box (Exst-Ppsd-Undefined)   Intelligent Transportation Pull Box (Exst, Ppsd)   Transformer (Exst, Ppsd)    Power Pole (Exst-Ppsd-with Transformer)   Wood Pole (Exst, Ppsd)   Pedestrian Push Button Post (Exst, Ppsd)  Existing Pole  Existing Telephone Pole  Existing Post     Connection Conductor (Ground, Neutral, Phase 1, Phase 2)
---	---	--

NORTH DAKOTA DEPARTMENT OF TRANSPORTATION	
07-01-14	
REVISIONS	
DATE	CHANGE
12-18-20	General Revisions



KIRK J. HOFF

REGISTERED

PROFESSIONAL

PE-4683

ENGINEER

NORTH DAKOTA

12 18 2020

LANE MARKERS
(Spotting Tab for Seal Projects only)

Notes:

1. Install lane line markers as shown, prior to beginning the seal coat.
2. Attach cover to vertical part of marker so traffic does not cause it to detach, but it can be easily removed manually.
3. Remove protective covers immediately after seal coat is applied.
4. Remove markers after permanent pavement marking is installed.
5. Use marker body and cover manufactured from polyurethane material.
6. Marker types:
Type Y - Yellow body and cover with yellow reflective tape on both sides.
Type W - White body and cover with white reflective tape on one side.
7. Use retroreflective tape with a minimum reflectance of 1200 candle power per foot-candle per square foot, using a .1 degree observation angle and 0 degree entrance angle.
8. Use adhesive conforming to AASHTO M 237.

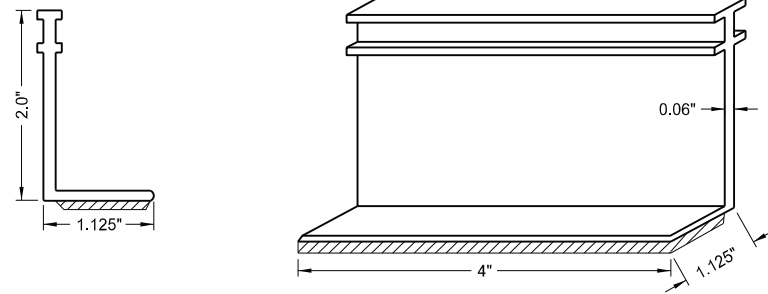

Marker Body

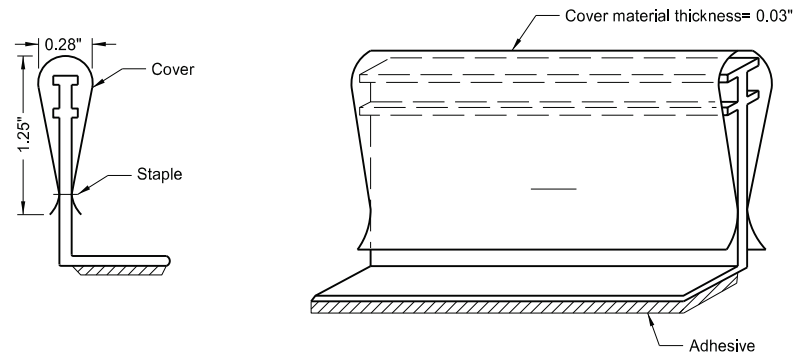

Marker Body with Protective Cover

NORTH DAKOTA DEPARTMENT OF TRANSPORTATION	
10-3-13	
REVISIONS	
DATE	CHANGE
9-27-17	Updated to active voice
10-03-19	New Design Engr PE Stamp
8-01-24	Electronic Stamp/Signature



08/01/24

BREAKAWAY SYSTEMS FOR CONSTRUCTION ZONE SIGNS

D-704-7

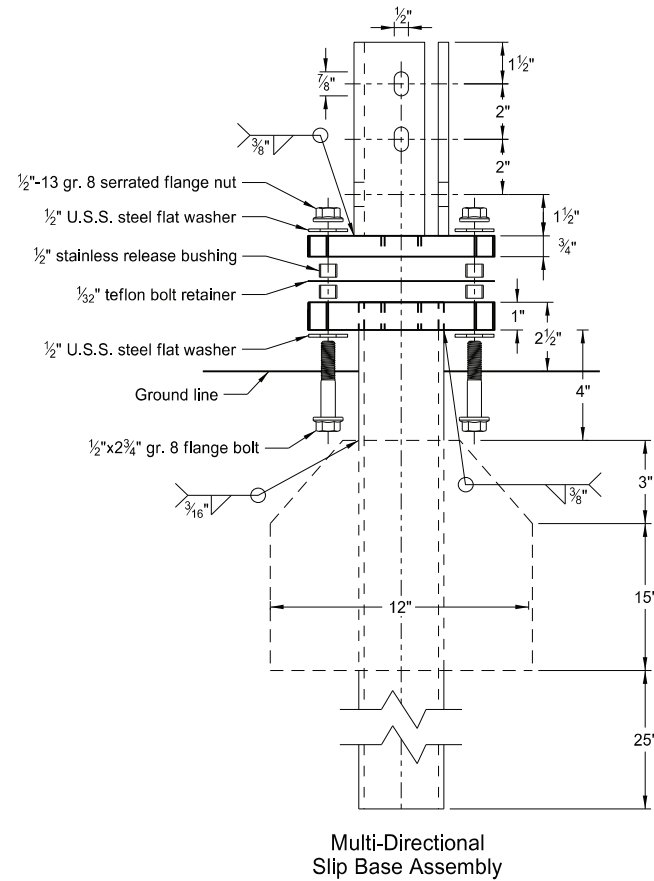

Perforated Tube

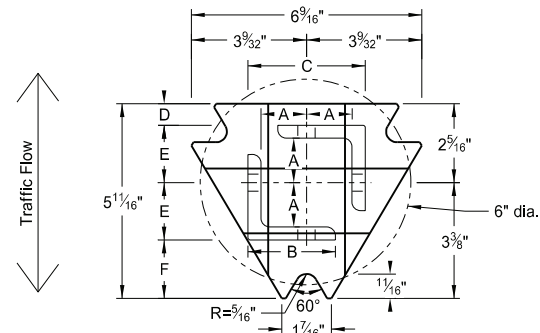
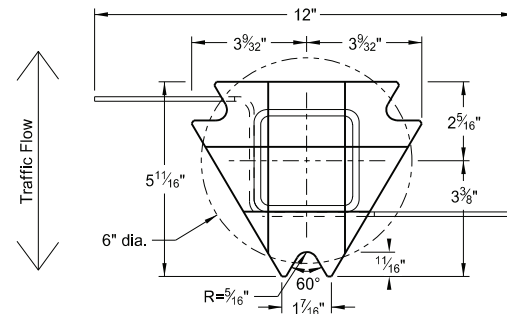
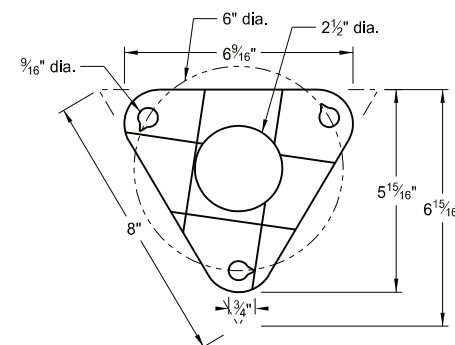

Plate - ASTM A572 grade 50
Angle Receiver - 2 1/2" x 2 1/2" x 3/8" ASTM A36 structural angle



Tube - 3"x3"x7 gauge ASTM A500 grade B tube
Stabilizing Wing - 7 gauge H.R.P.O. ASTM A1011
Plate - ASTM A572 grade 50



Bolt Retainer - 1/2" Reprocessed Teflon

Notes:

1. Torque slip base bolts as specified by manufacturer.
2. Use anchor with 43.9 KSI yield strength and 59.3 KSI tensile strength.
3. Provide 4" vertical clearance for anchor or breakaway base. Measure the 4"x60" measurement above and below post location and back and ahead of post.
4. In concrete sidewalk, use same anchor without wings.
5. Provide more than 7' between the first and fourth posts of a four post sign.

Telescoping Perforated Tube

Number of Posts	Post Size in.	Wall Thickness Gauge	Sleeve Size in.	Wall Thickness Gauge	Slip Base	Anchor Size without Slip Base in.
1	2	12			No	2 1/4
1	2 1/4	12			No	2 1/2
1	2 1/2	12			(A)	3
1	2 1/2	10			Yes	
1	2 1/4	12	2	12	Yes	
1	2 1/2	12	2 1/4	12	Yes	
2	2	12			No	2 1/4
2	2 1/4	12			No	2 1/2
2	2 1/2	12			Yes	
2	2 1/2	12			Yes	
2	2 1/4	10	2	12	Yes	
3 & 4	2 1/2	12			Yes	
3 & 4	2 1/2	10			Yes	
3 & 4	2 1/2	12	2 1/4	12	Yes	
3 & 4	2 1/4	12	2	12	Yes	
3 & 4	2 1/2	10	2 3/16	10	Yes	

Properties of Telescoping Perforated Tube

Tube Size in.	Wall Thickness in.	U.S. Standard Gauge	Weight per Foot lbs.	Moment of Inertia in. ⁴	Cross Sec. Area in. ²	Section Modulus in. ³
1 1/2 x 1 1/2	0.105	12	1.702	0.129	0.380	0.172
2 x 2	0.105	12	2.416	0.372	0.590	0.372
2 1/4 x 2 1/4	0.105	12	2.773	0.561	0.695	0.499
2 3/16 x 2 3/16	0.135	10	3.432	0.605	0.841	0.590
2 1/2 x 2 1/2	0.105	12	3.141	0.804	0.803	0.643
2 1/2 x 2 1/2	0.135	10	4.006	0.979	1.010	0.785

Top Post Receiver Data Table

Square Post Sizes (B)	A	B	C	D	E	F
2 3/16" x 10 ga.	1 5/64"	2 1/2"	3 1/32"	2 5/32"	1 33/64"	1 7/8"
2 1/2" x 10 ga.	1 3/32"	2 1/2"	3 5/16"	5/8"	1 21/32"	1 3/4"

(A) Use breakaway base when support is placed in weak soils. Engineer determines if soils are weak.

(B) For additional wind load, insert the 2 3/16" x 10 ga. into 2 1/2" x 10 ga.

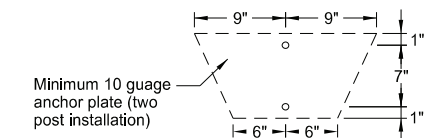
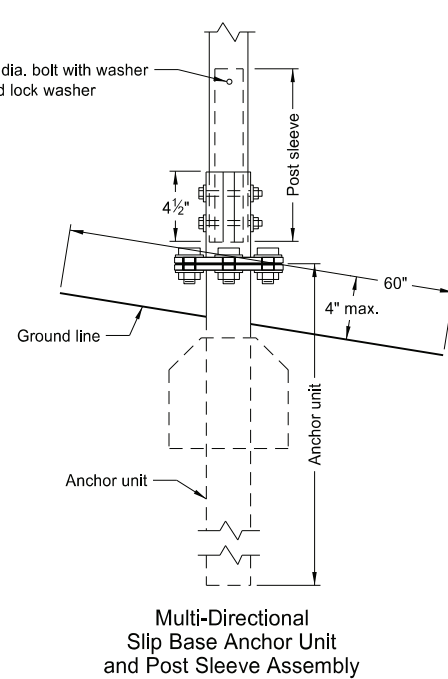
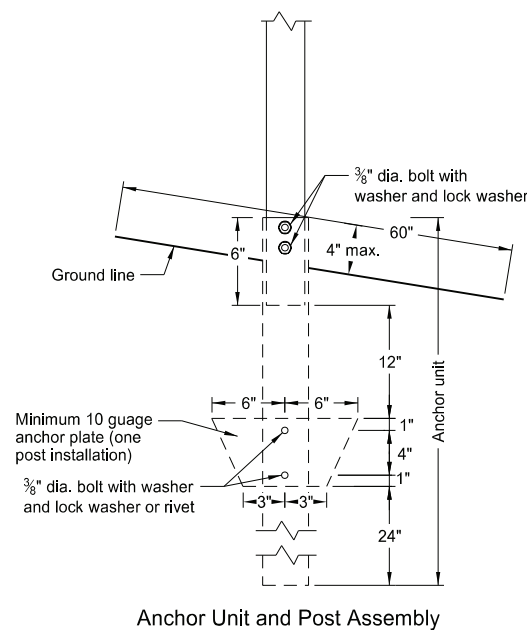

NORTH DAKOTA DEPARTMENT OF TRANSPORTATION	
2-28-14	
REVISIONS	
DATE	CHANGE
9-27-17	Updated to active voice
10-03-19	New Design Engr PE Stamp
8-01-24	Electronic Stamp/Signature



08/01/24

BREAKAWAY SYSTEMS FOR CONSTRUCTION ZONE SIGNS

D-704-8

U-Channel Post

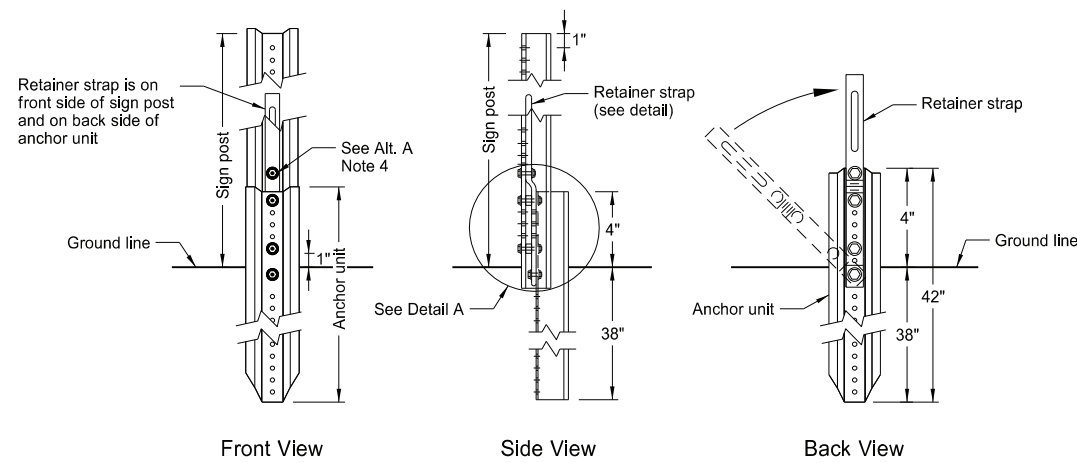
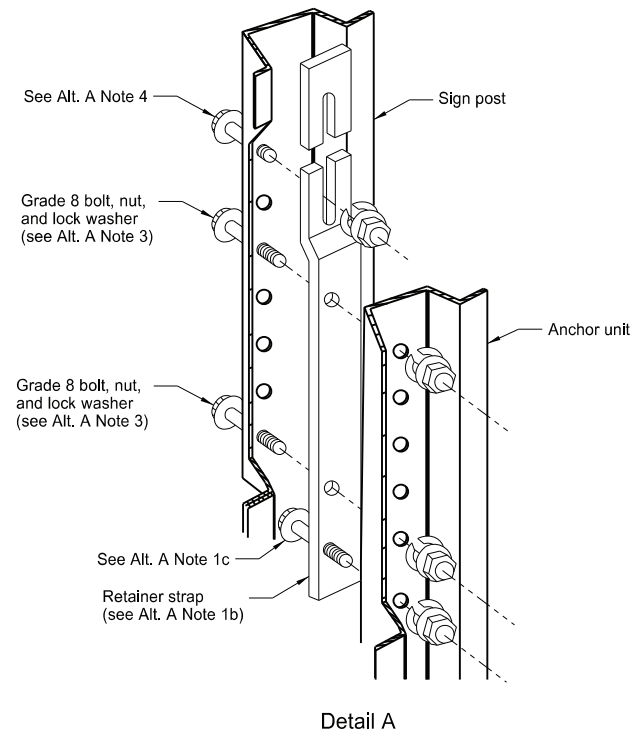

Breakaway U-Channel Detail Alternate A
Install a maximum of 2 posts within 7'.

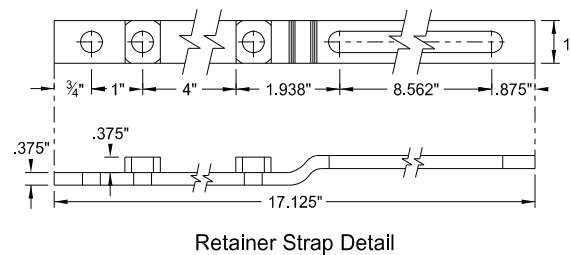

Retainer Strap Detail

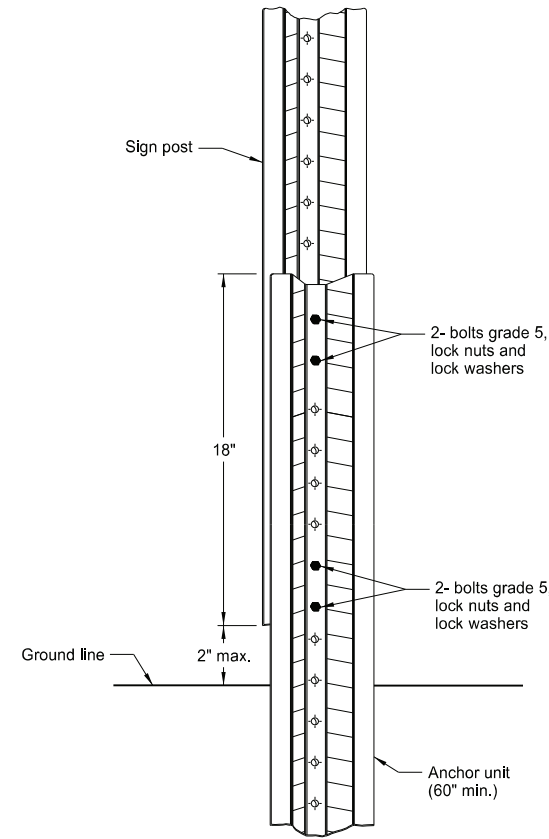

Breakaway U-Channel Splice Detail Alternate B
(2.5 and 3 lb/ft)
Install a maximum of 3 posts within 7'.

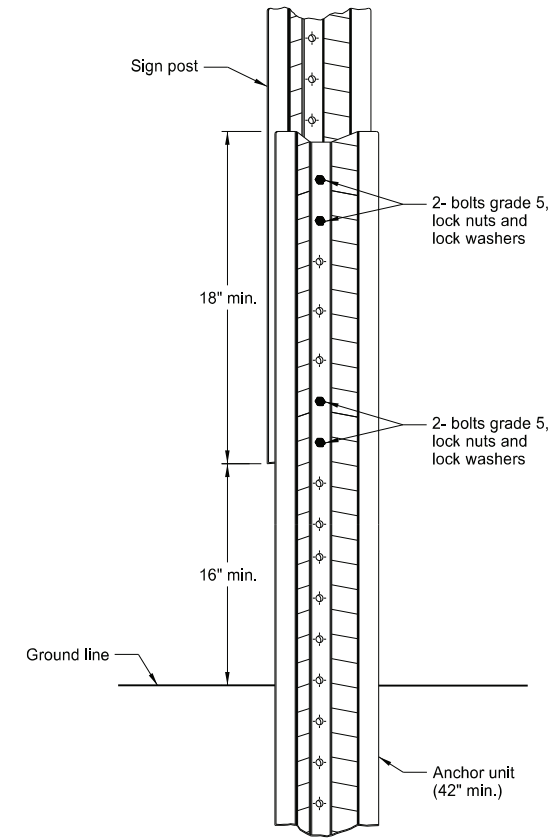

Breakaway U-Channel Splice Detail Alternate C
(2.5 and 3 lb/ft)
Install a maximum of 3 posts within 7'.

Alternate A Steps of Installation:

- Drive anchor unit to within 12" of ground level.
 - Establish proper assembly by lining up bottom hole of retainer strap with 6th hole from the top of the anchor unit.
 - Assemble strap to back of anchor unit using 5/16"x2" bolt, lock washer and nut.
 - Rotate strap 90° to left.
- Drive anchor unit to 4" above ground.
 - Rotate strap to vertical position.
- Place 5/16"x2" bolt, lock washer and nut in bottom of sign post to facilitate alignment of sign post with proper hole in anchor unit.
 - Alternately tighten two connector bolts.
- Complete assembly by tightening 5/16"x2" bolt (this fastens sign post to retainer strap).
- Properly nest base post, strap, and sign post. Proper nesting occurs when all flat surfaces of the base post, strap, and sign post at the bolts have full contact across the entire width.

NORTH DAKOTA DEPARTMENT OF TRANSPORTATION	
2-28-14	
REVISIONS	
DATE	CHANGE
9-27-17	Updated to active voice
10-03-19	New Design Engr PE Stamp
8-01-24	Electronic Stamp/Signature



08/01/24

CONSTRUCTION SIGN DETAILS
TERMINAL AND GUIDE SIGNS



G20-1-60
Legend: black (non-refl)
Background: orange

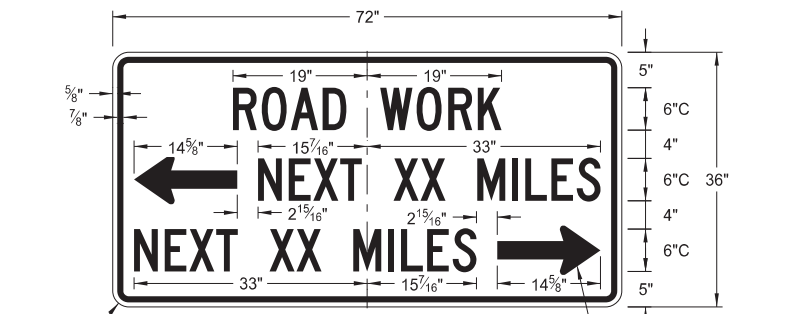

G20-50a-72
Legend: black (non-refl)
Background: orange

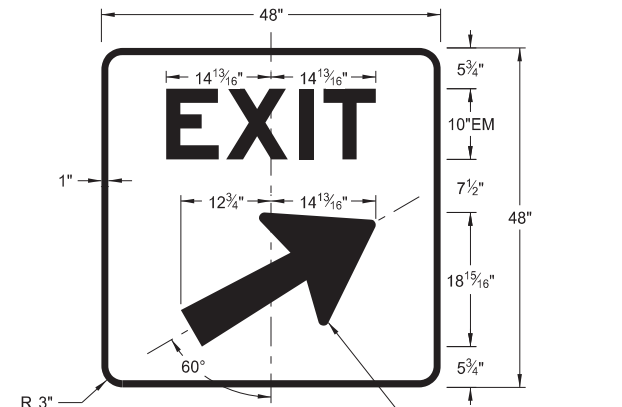

E5-1(L or R)-48
Legend: white
Background: green (orange optional)

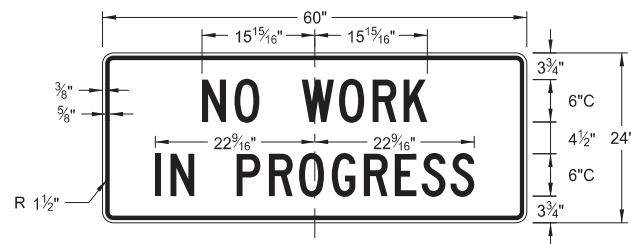
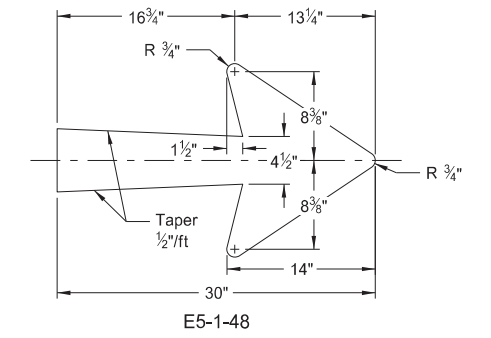

G20-1b-60
Legend: black (non-refl)
Background: orange

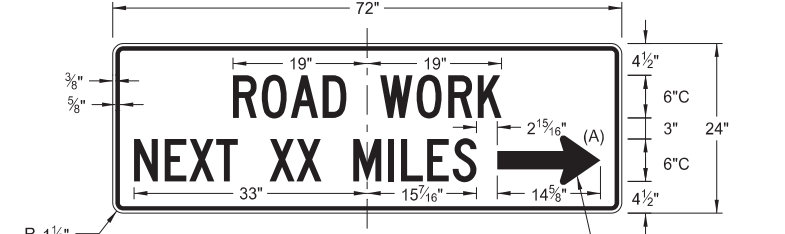

G20-52a-72
Legend: black (non-refl)
Background: orange

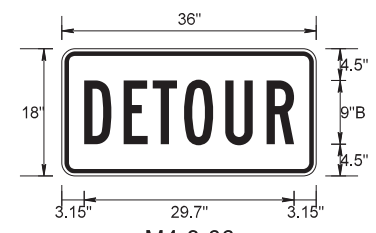

M4-8-36
Legend: black (non-refl)
Background: orange

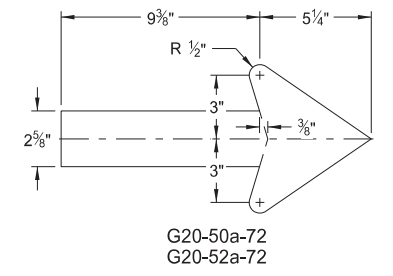

G20-50a-72
G20-52a-72

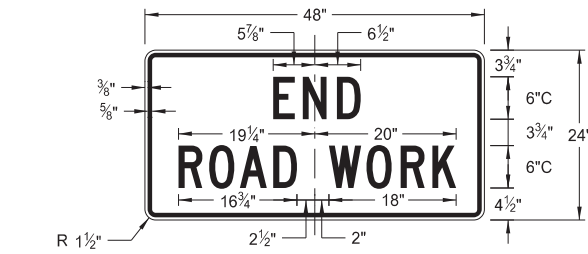

G20-2-48
Legend: black (non-refl)
Background: orange

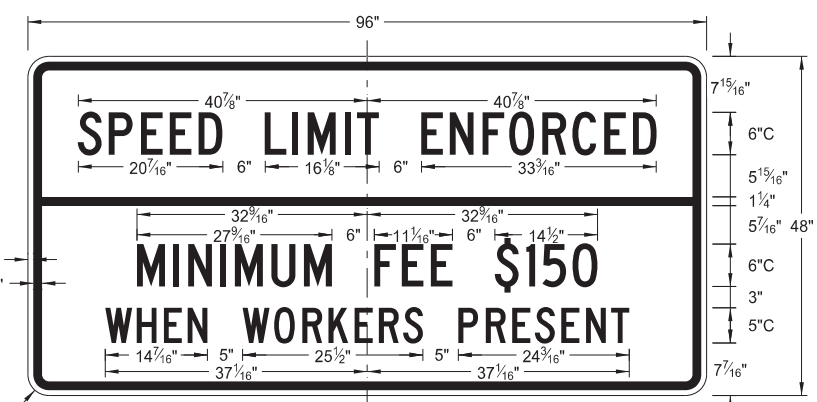

G20-55-96
Legend: black (non-refl)
Background: orange

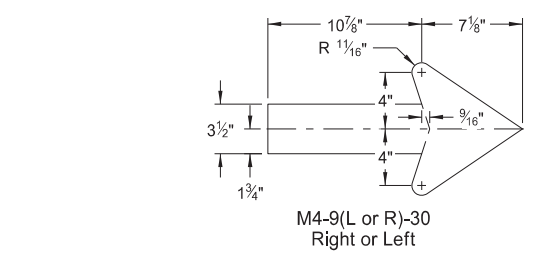

M4-9(L or R)-30
Right or Left

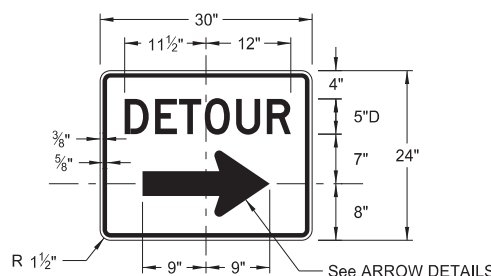

M4-9(L or R)-30 &
M4-9-30
Legend: black (non-refl)
Background: orange

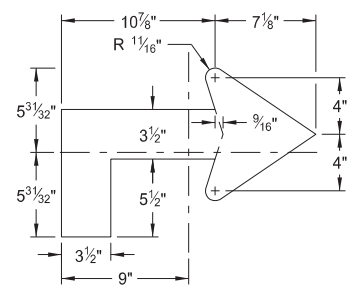

M4-9(L or R)-30
Advanced Right or Left

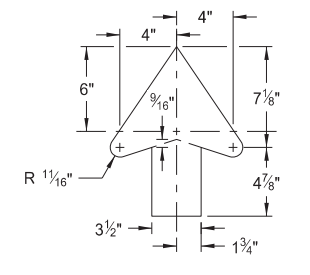

M4-9-30
Straight

ARROW DETAILS

NOTES:

(A) Arrow may be right or left of the legend to indicate construction to the right or left.

NORTH DAKOTA DEPARTMENT OF TRANSPORTATION	
8-13-13	
REVISIONS	
DATE	CHANGE
08-17-17	Added sign & background color
10-03-19	New Design Engineer PE Stamp
08-01-24	Electronic Stamp/Signature
06-30-25	Legislative Changes



CONSTRUCTION SIGN DETAILS
REGULATORY SIGNS

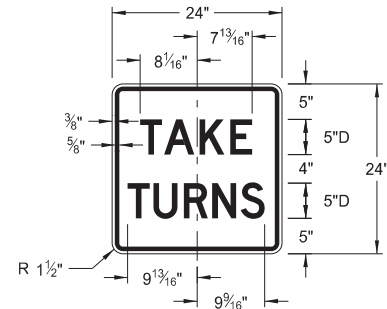

R1-50P-24
Legend: black (non-refl)
Background: white

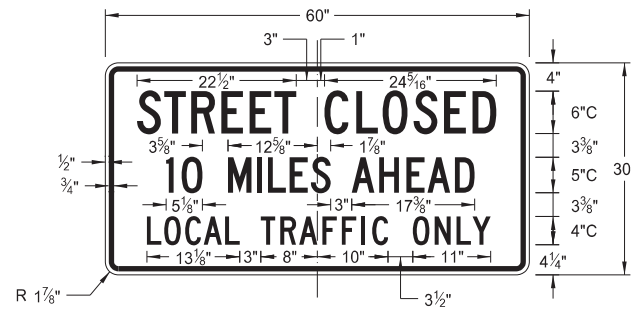

R11-3c-60
Legend: black (non-refl)
Background: white

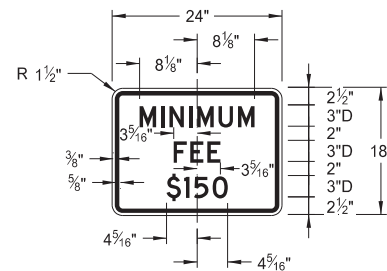

R2-1aP-24
Legend: black (non-refl)
Background: white

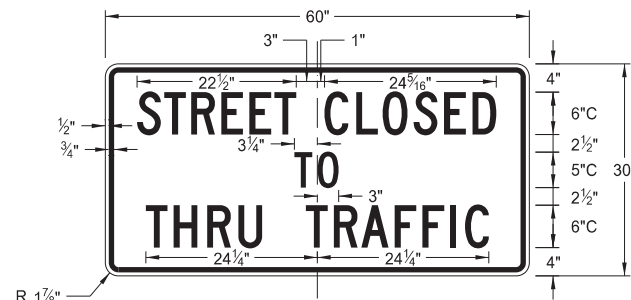

R11-4a-60
Legend: black (non-refl)
Background: white

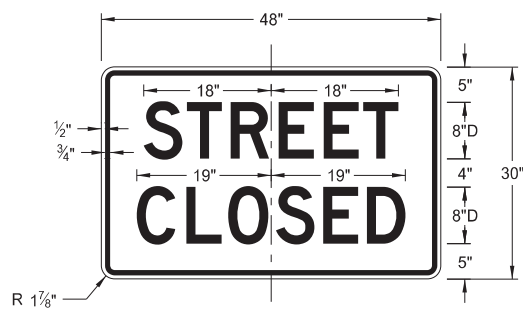

R11-2a-48
Legend: black (non-refl)
Background: white

NORTH DAKOTA DEPARTMENT OF TRANSPORTATION	
8-13-13	
REVISIONS	
DATE	CHANGE
08-17-17	Revised sign number
10-03-19	New Design Engineer PE Stamp
08-01-24	Electronic Stamp/Signature
06-30-25	Legislative Changes



CONSTRUCTION SIGN DETAILS
WARNING SIGNS

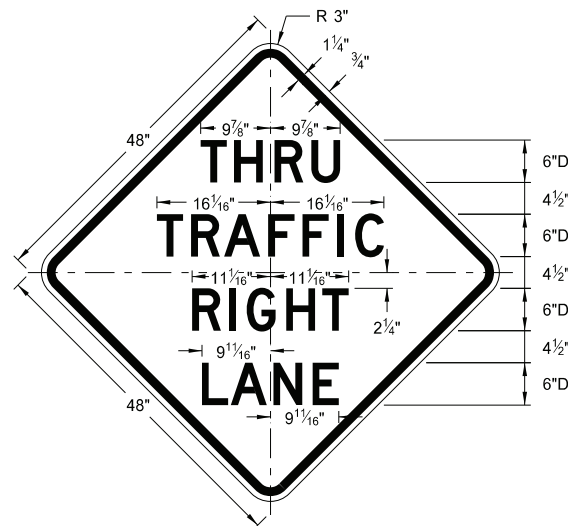

W5-8-48
Legend: black (non-refl)
Background: orange

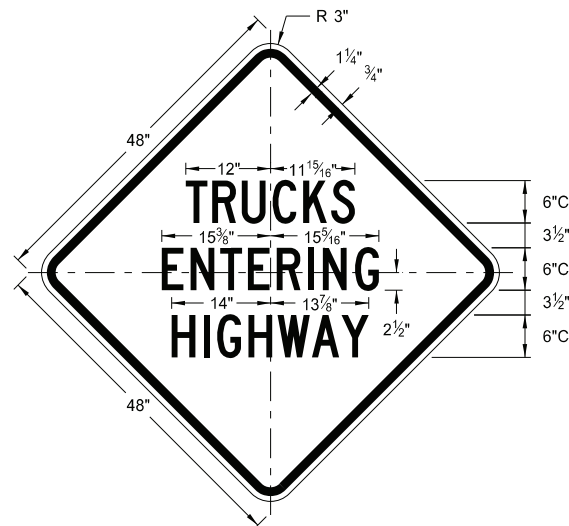

W8-53-48
Legend: black (non-refl)
Background: orange

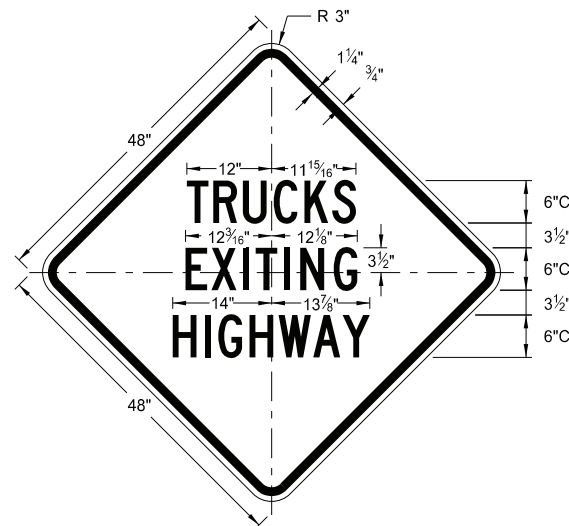

W8-56-48
Legend: black (non-refl)
Background: orange

WORD	LETTER SPACING
AHEAD	Standard
200 FT	Standard
350 FT	Standard
500 FT	Standard
1000 FT	Reduce 40%
1500 FT	Reduce 40%
½ MILE	Reduce 50%
1 MILE	Standard

* DISTANCE MESSAGES

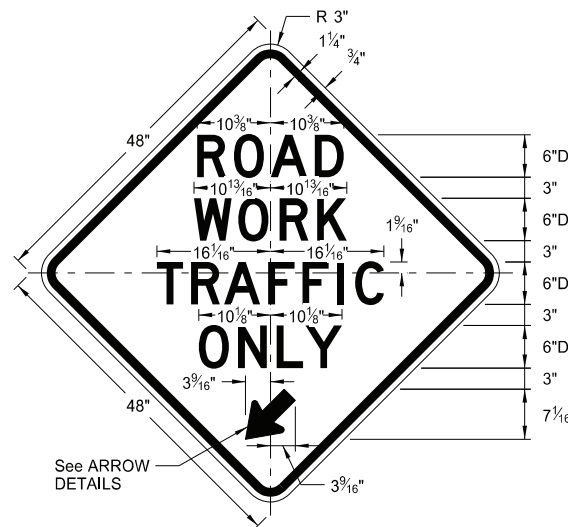

W5-9-48
Legend: black (non-refl)
Background: orange

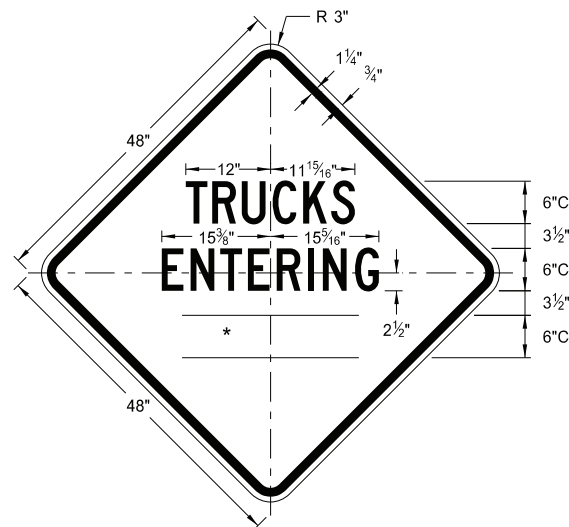

W8-54-48
Legend: black (non-refl)
Background: orange

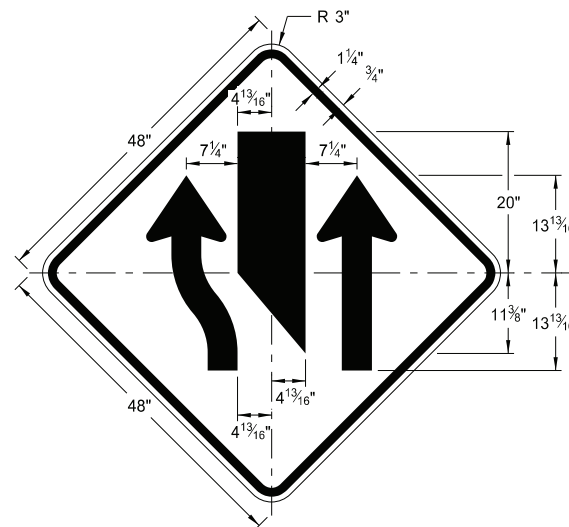

W9-3a-48
Legend: black (non-refl)
Background: orange

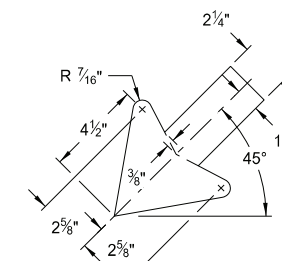

W5-9-48

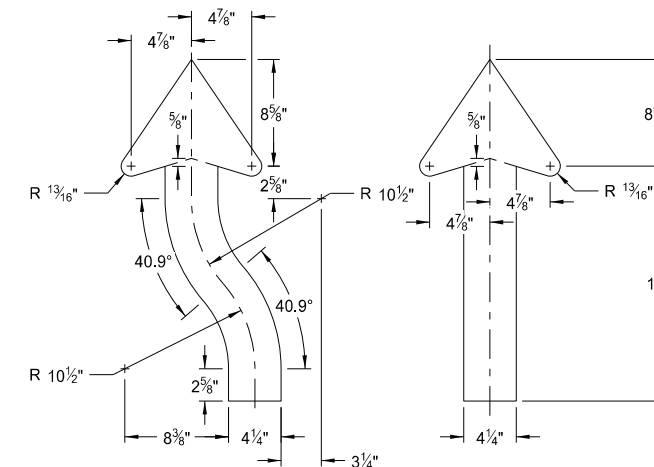

W9-3a-48

ARROW DETAILS

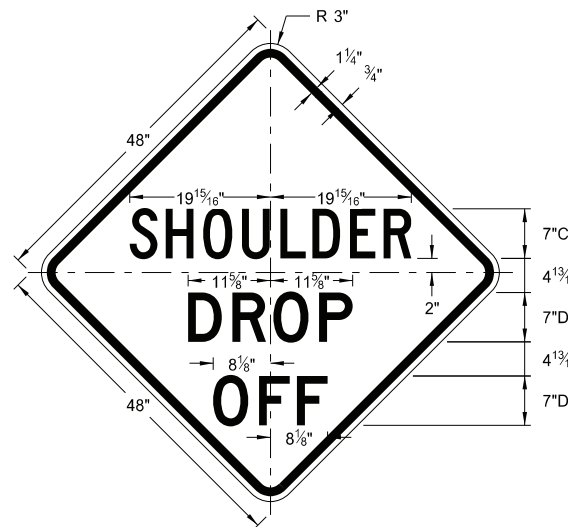

W8-9a-48
Legend: black (non-refl)
Background: orange

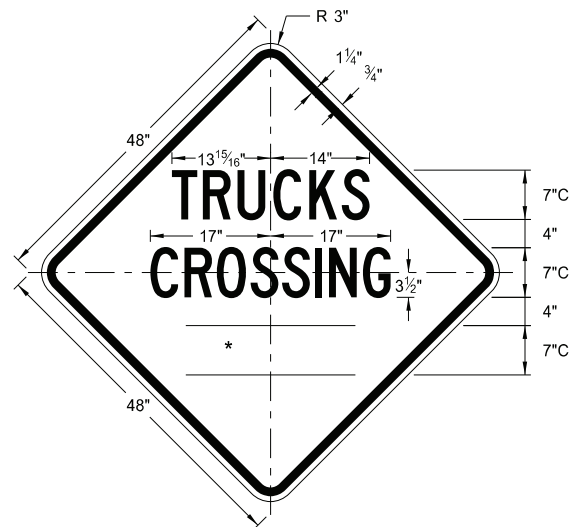

W8-55-48
Legend: black (non-refl)
Background: orange

NORTH DAKOTA DEPARTMENT OF TRANSPORTATION	
8-13-13	
REVISIONS	
DATE	CHANGE
8-17-17	Updated sign number
5-31-18	Revised sign and arrow details
10-03-19	New Design Engineer PE Stamp
8-01-24	Electronic Stamp/Signature



08/01/24

CONSTRUCTION SIGN DETAILS
WARNING SIGNS

WORD	LETTER SPACING
AHEAD	Standard
200 FT	Standard
350 FT	Standard
500 FT	Standard
1000 FT	Reduce 40%
1500 FT	Reduce 40%
½ MILE	Reduce 50%
1 MILE	Standard

* DISTANCE MESSAGES

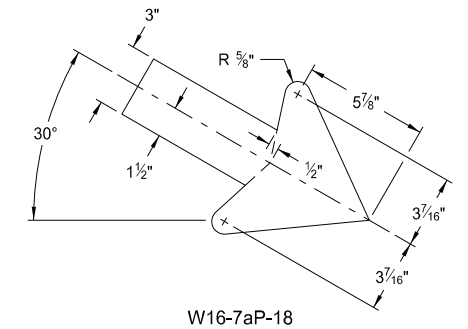

W16-7aP-18
Legend: black (non-refl)
Background: orange

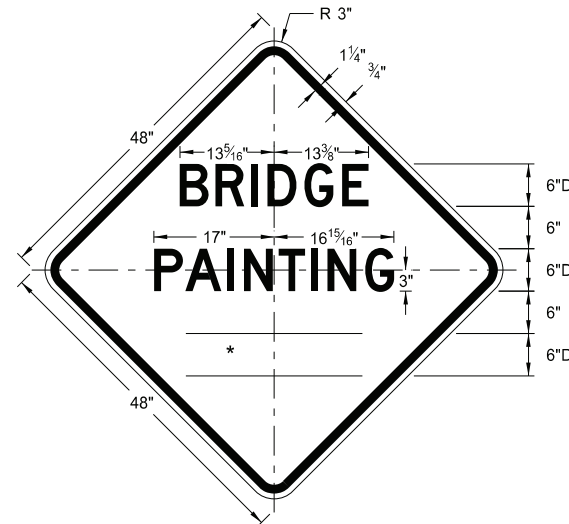

W21-50-48
Legend: black (non-refl)
Background: orange

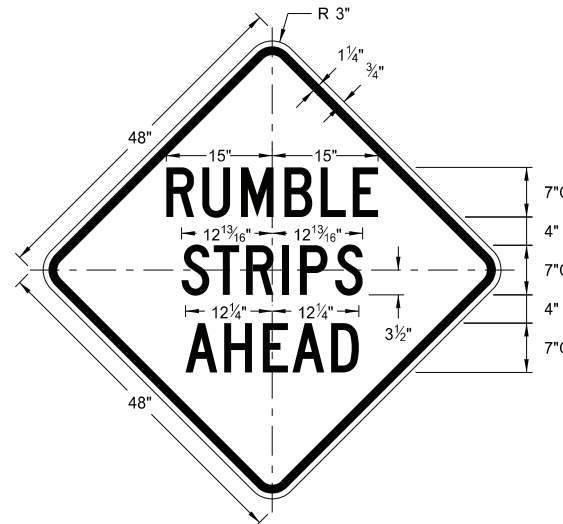

W21-53-48
Legend: black (non-refl)
Background: orange

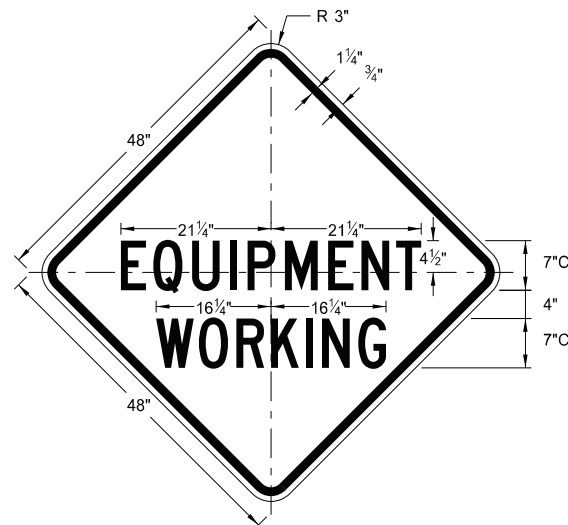

W20-51-48
Legend: black (non-refl)
Background: orange

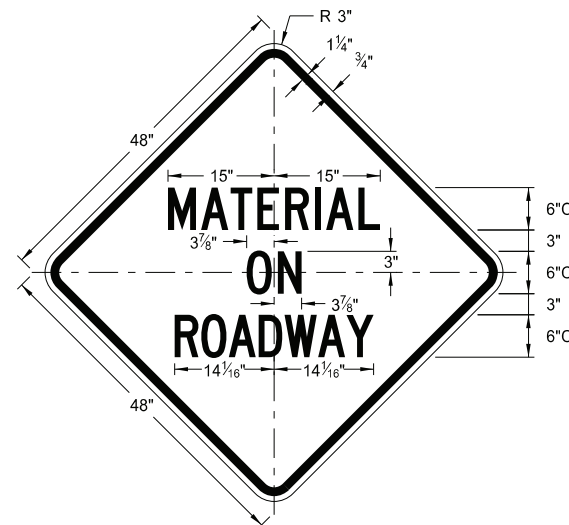

W21-51-48
Legend: black (non-refl)
Background: orange

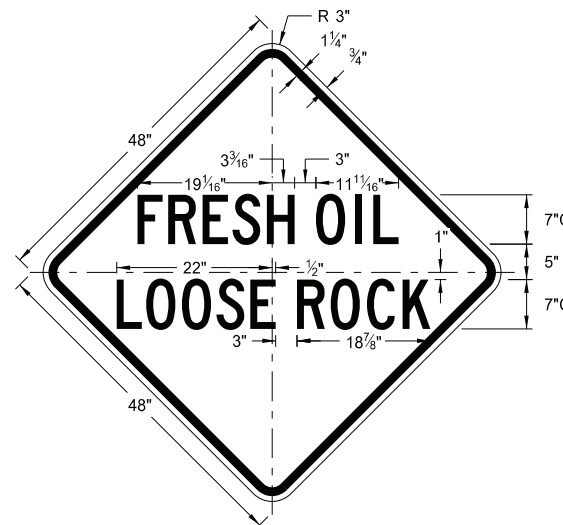

W22-8-48
Legend: black (non-refl)
Background: orange

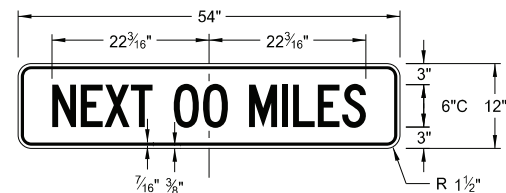

W20-52P-54
Legend: black (non-refl)
Background: orange

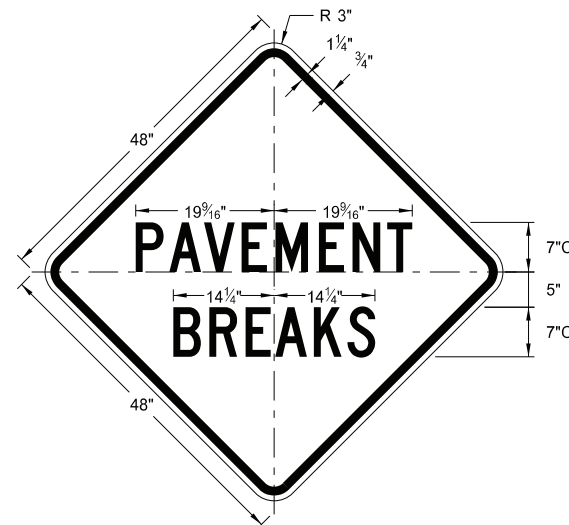

W21-52-48
Legend: black (non-refl)
Background: orange

NORTH DAKOTA
DEPARTMENT OF TRANSPORTATION
5-31-18

DATE	CHANGE
11-01-19	Added details for sign W16-7aP-18.
8-01-24	Electronic Stamp/Signature.



08/01/24

BARRICADE AND CHANNELIZING DEVICE DETAILS

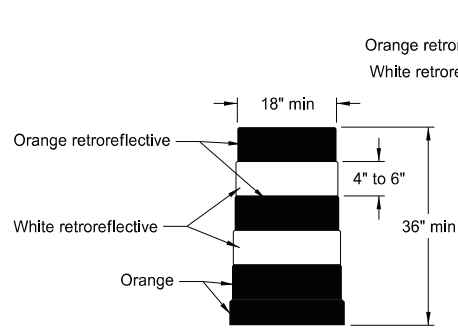

DELINEATOR DRUM

Provide horizontal, circumferential, alternating orange and white retroreflective stripes 4" to 6" wide for drum markings. Use a minimum of two orange and two white stripes with the top stripe being orange for each drum. Do not exceed 3" nonretroreflective spaces between the horizontal orange and white stripes. Avoid placement of stripes on drum ribs or indentations. Use closed top drums that will not allow collection of debris. Do not place ballast on the top of drum.

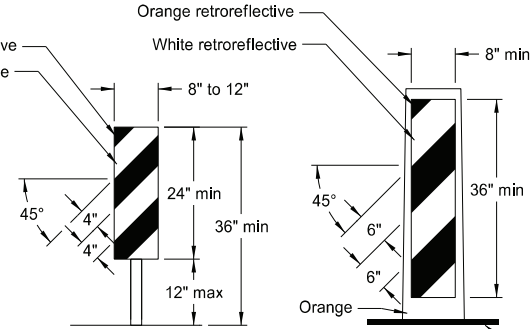

VERTICAL PANEL

Provide alternating orange and white retroreflective stripes, sloping downward in direction vehicular traffic is to pass. Place retroreflective sheeting on both sides of panel with a minimum of 270 square inches of retroreflective area facing vehicular traffic. Where the height of the retroreflective material on the vertical panel is 36 inches or more, use a stripe width of 6 inches.

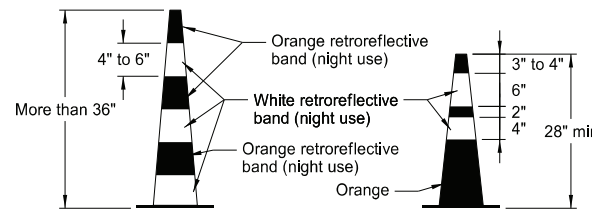

TRAFFIC CONE

Provide retroreflectization of cones more than 36" in height by alternating orange and white retroreflective stripes. Use a minimum of two orange and two white stripes for each cone with the top stripe being orange. Use maximum 3" nonretroreflective space between the orange and white stripes.

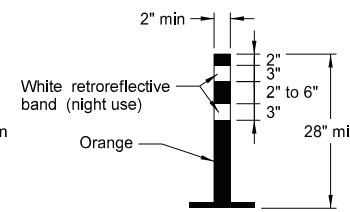

TUBULAR MARKER

Provide retroreflectization of tubular markers more than 42" in height by alternating four 4" to 6" wide orange and white stripes with the top stripe being orange.

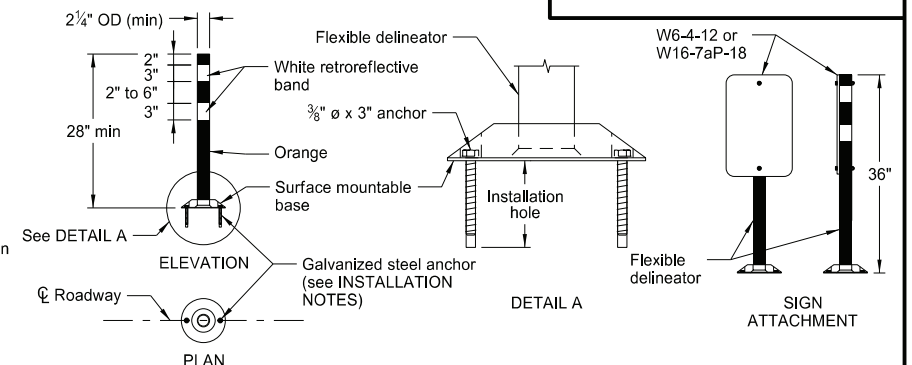

FLEXIBLE DELINEATOR

INSTALLATION NOTES:

1. Drill installation holes to diameter and depth required by manufacturer's specifications.
2. For removal, remove anchors and fill installation hole with an epoxy designed to bond to pavement surface.
3. In lieu of bolted down base, use an 8" x 8" butyl pad or hot melt butyl. Remove butyl as close as possible to pavement surface.

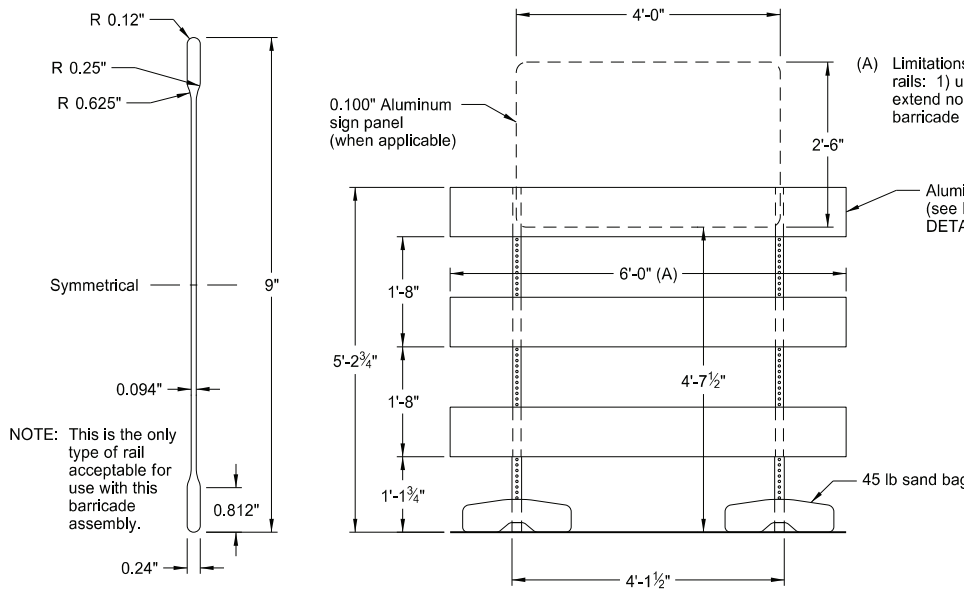

BARRICADE BLADE DETAIL

NOTE: This is the only type of rail acceptable for use with this barricade assembly.

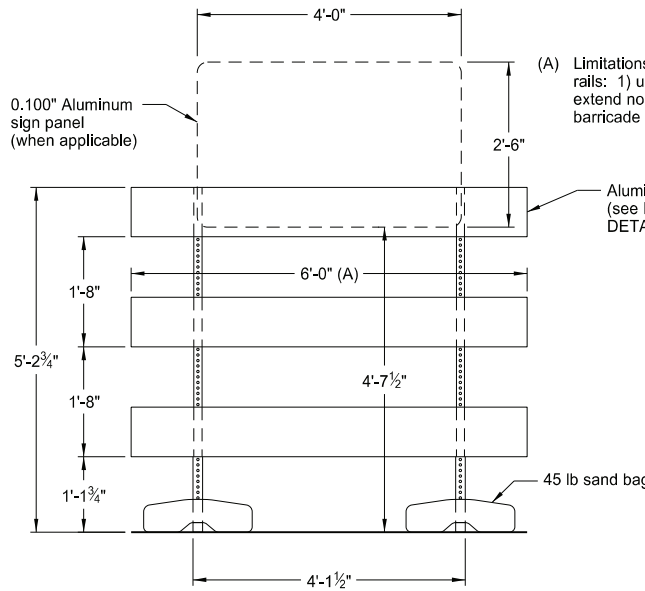

ELEVATION VIEW

BARRICADE ASSEMBLY DETAIL (Aluminum Barricade Rails)

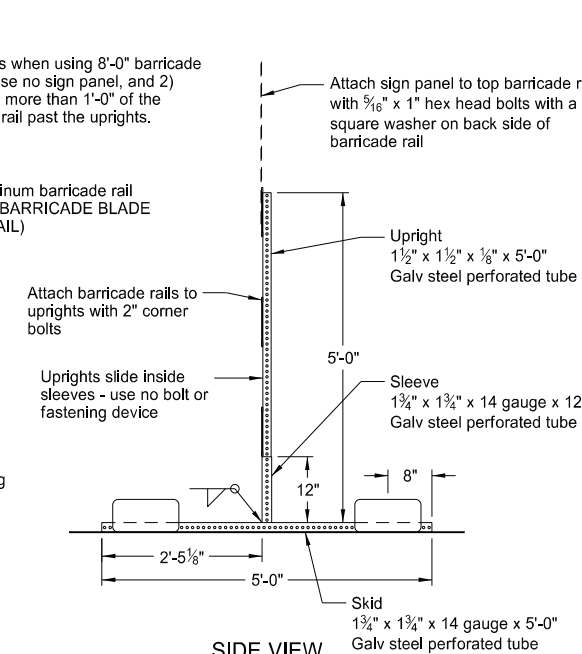

SIDE VIEW

BARRICADE ASSEMBLY DETAIL (Wood or Plastic Rails)

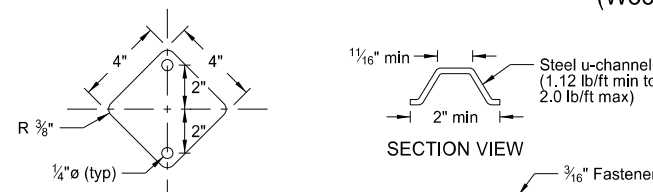

REFLECTOR DETAIL

SECTION VIEW

MOUNTING DETAIL

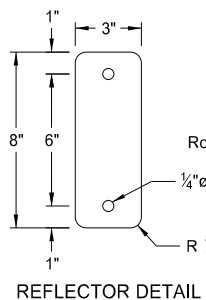

DELINEATORS

ELEVATION VIEW

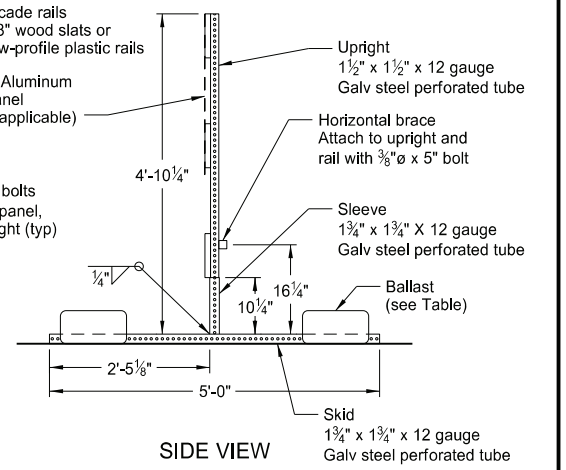

SIDE VIEW

MINIMUM BALLAST (For each side of barricade support)

Without Sign	4 - 25 lb sandbags
With Sign	6 - 25 lb sandbags

Note: Number of sandbags based on a wind speed of 55 MPH. Sandbags assumed to be placed at or near the ends of the skids.

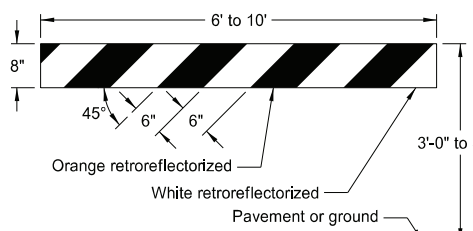

TYPE I BARRICADE

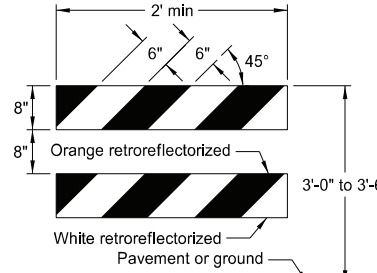

TYPE II BARRICADE

BARRICADE RAIL DETAILS

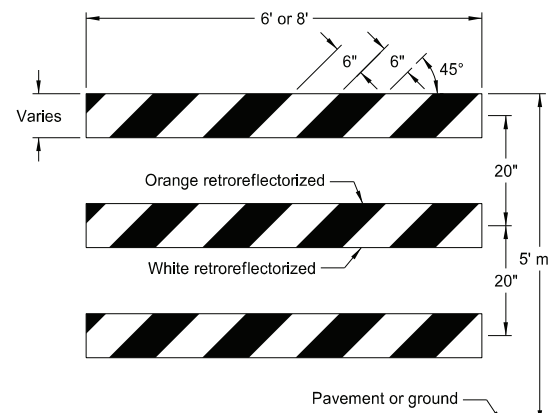

TYPE III BARRICADE

NORTH DAKOTA DEPARTMENT OF TRANSPORTATION	
10-3-13	
REVISIONS	
DATE	CHANGE
9-27-17	Updated to active voice
11-01-19	Revised details for Flexible Delineator
8-01-24	Electronic Stamp/Signature



08/01/24

CONSTRUCTION SIGN PUNCHING AND MOUNTING DETAILS

Note: In curb sections, place signs a minimum horizontal distance of 2' from face of the curb to near edge of the sign.

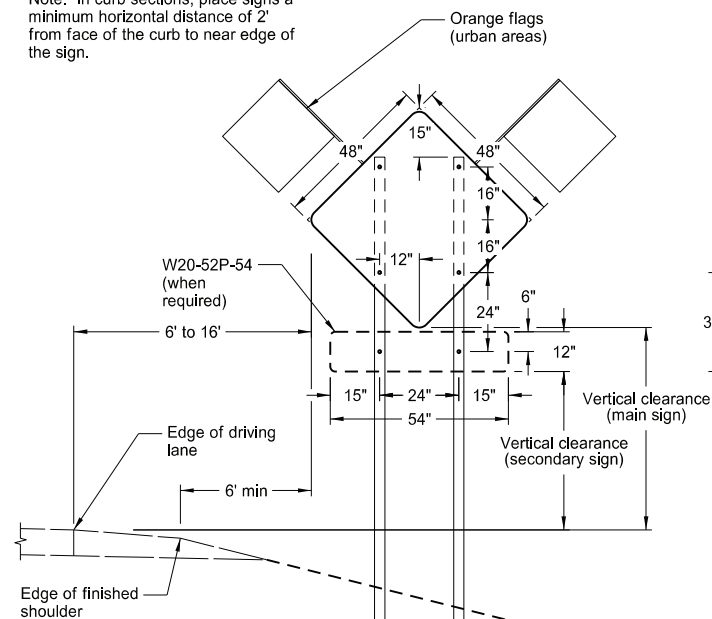

TYPICAL SECTION
(48" x 48" diamond warning sign shown)

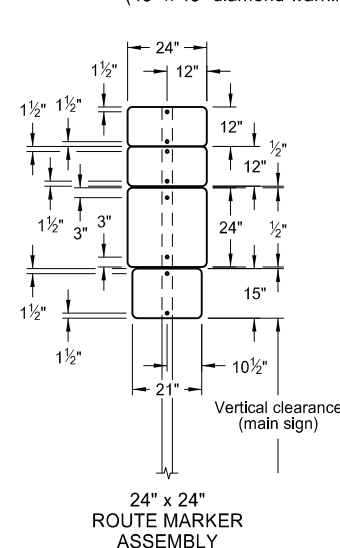

24" x 24" ROUTE MARKER ASSEMBLY

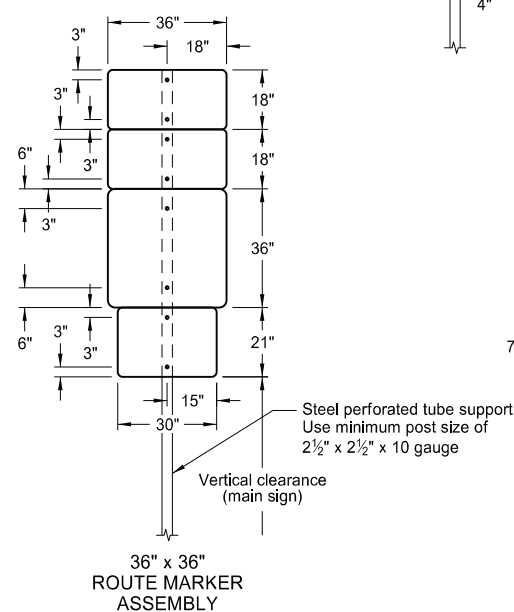

36" x 36" ROUTE MARKER ASSEMBLY

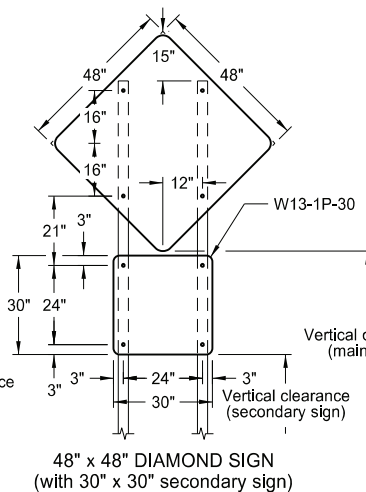

48" x 48" DIAMOND SIGN
(with 30" x 30" secondary sign)

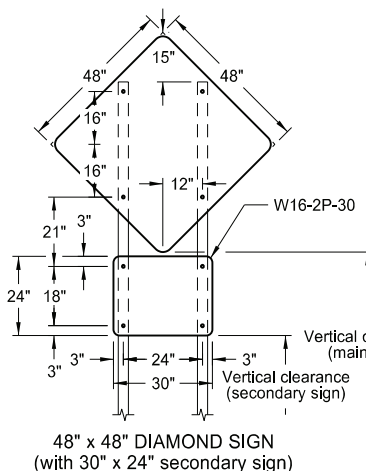

48" x 48" DIAMOND SIGN
(with 30" x 24" secondary sign)

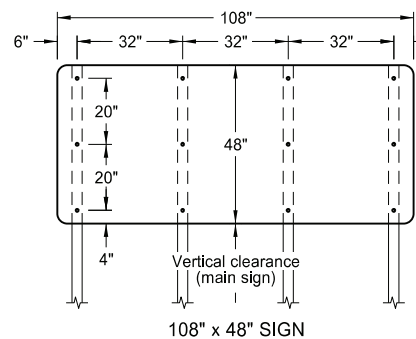

108" x 48" SIGN

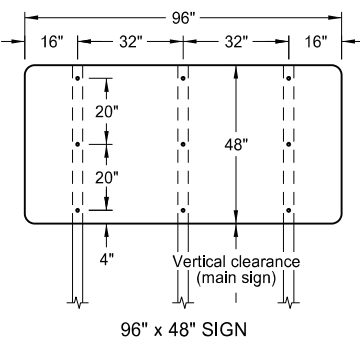

96" x 48" SIGN

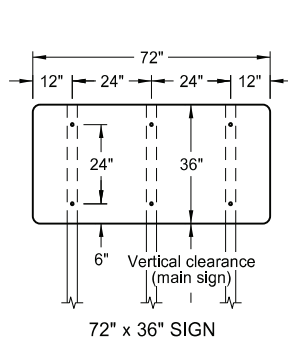

72" x 36" SIGN

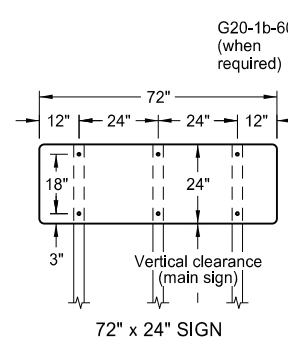

72" x 24" SIGN

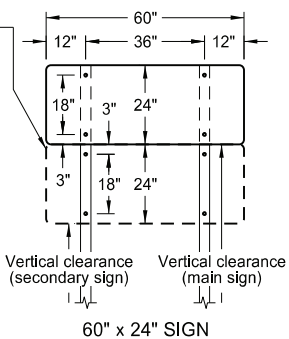

60" x 24" SIGN

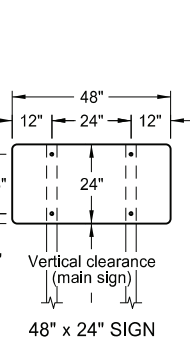

48" x 24" SIGN

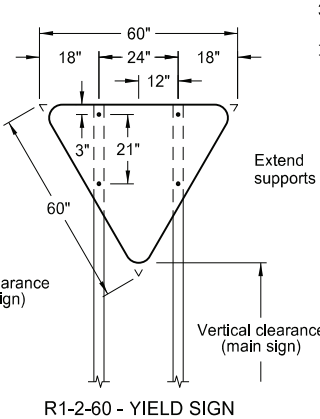

R1-2-60 - YIELD SIGN

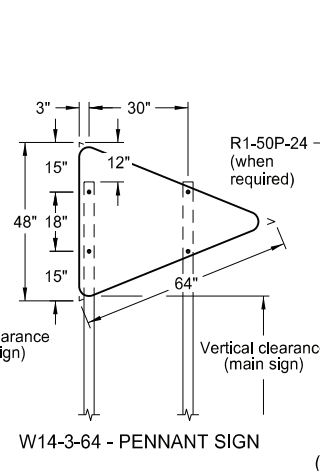

W14-3-64 - PENNANT SIGN

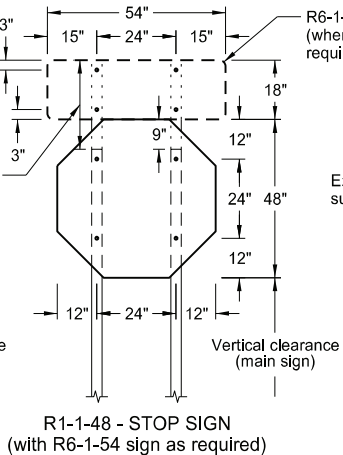

R1-1-48 - STOP SIGN
(with R6-1-54 sign as required)

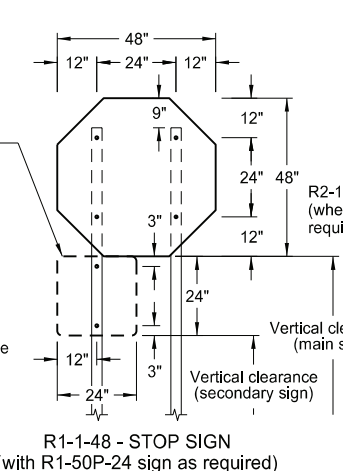

R1-1-48 - STOP SIGN
(with R1-50P-24 sign as required)

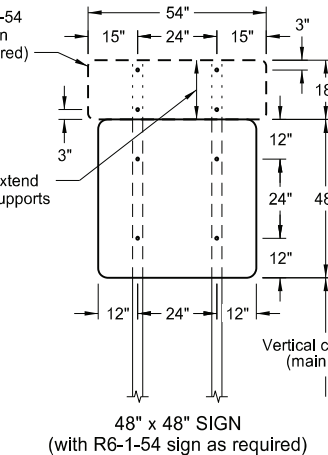

48" x 48" SIGN
(with R6-1-54 sign as required)

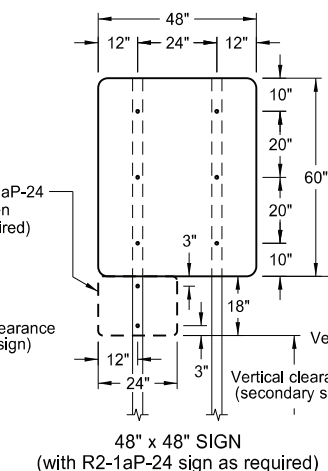

48" x 48" SIGN
(with R2-1aP-24 sign as required)

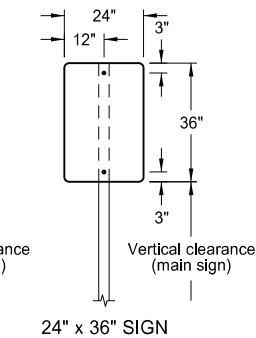

24" x 36" SIGN

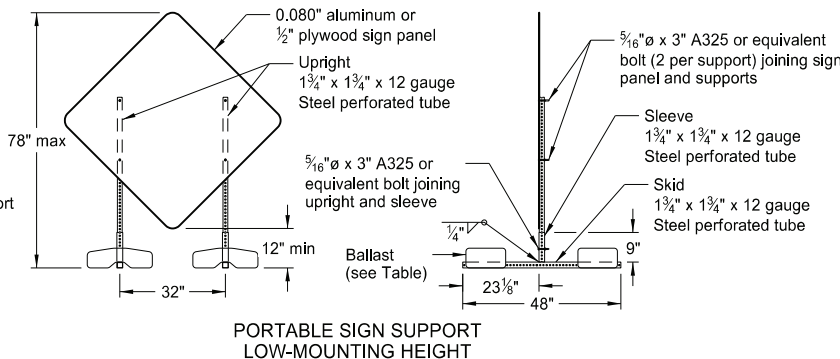

PORTABLE SIGN SUPPORT
LOW-MOUNTING HEIGHT

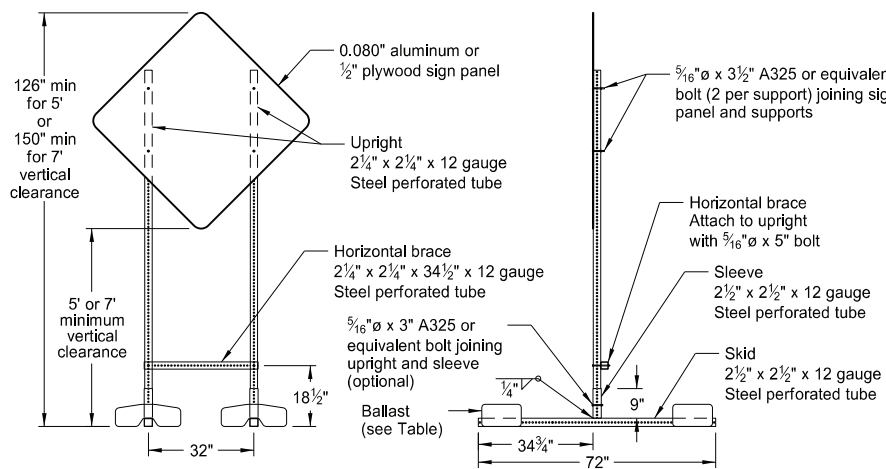

PORTABLE SIGN SUPPORT
HIGH-MOUNTING HEIGHT

NOTES:

- Sign Supports: Galvanize or paint supports. Minimum post sizes are 2.5 lb/ft u-channel or 2" x 2" x 12 gauge steel perforated tube, except where noted. When installing signs on u-channel, minimum post size for assemblies containing a secondary sign is 3.0 lb/ft. Post sizes based on a wind speed of 55 MPH.

Place signs over 50 square feet on 2 1/2" x 2 1/2" perforated tube supports as a minimum.

Do not attach guy wires to sign supports. Attach wind beams behind sign panels when used with u-posts.
- Sign Panels: Provide sign panels made of 0.100" aluminum, 1/2" plywood, or other approved material, except where noted. Punch all holes round for 3/8" bolts.
- Alternate Messages: Install and remove alternate message signs on reflectorized plate (without borders) as required. (i.e. "Left" and "Right" message on lane closure sign)
- Route Marker Auxiliary Signs: Provide route marker auxiliary signs, such as the cardinal direction and directional arrows, with a background and legend that match the route marker they are used with:

Interstate - white legend on blue background
Interstate Business Loop - white legend on green background
US and State - black legend on white background
County - yellow legend on blue background

- Vertical Clearance: Install signs with a vertical clearance of 5'-0" (see TYPICAL SECTION.) In areas where parking or pedestrian movements are likely or the view of the sign may be obstructed, install signs with a vertical clearance of 7'-0" from the top of the curb or from the near edge of the driving lane in absence of a curb.

The vertical clearance to secondary signs is 1'-0" less than the vertical clearance stated above.

Provide a minimum clearance of 7'-0" from the ground at the post for signs with an area exceeding 50 square feet.

- Portable Signs: Provide portable signs that meet the vertical clearance stated above when it is necessary to place signs within the pavement surface.

Use of low-mounting height (minimum 12" vertical clearance) portable signs for 5 days or less, is allowed as long as the view of the sign is not obstructed. Time delays caused by unforeseen circumstances, such as equipment breakdown, rain, subgrade failures, etc., will not accrue towards the 5 day period. Use of R9-8 through R9-11a series, W1-6 through W1-8 series, M4-10, and E5-1 is allowed for longer than 5 days.

Restrict signs mounted on portable sign supports shown in the LOW-MOUNTING HEIGHT and HIGH-MOUNTING HEIGHT details to a maximum surface area of 16 square feet.

MINIMUM BALLAST
(For each side of sign support base)

Sign Panel Mounting Height (ft)	Number of 25 lb sandbags for 4' x 4' sign panel
1'	6
5'	8
7'	10

Note: The number of sandbags are based on a wind speed of 55 MPH. Place sandbags at or near the ends of sklds.

NORTH DAKOTA DEPARTMENT OF TRANSPORTATION	
10-4-13	
REVISIONS	
DATE	CHANGE
11-14-13	Revised Note 6
9-27-17	Updated to active voice
11-01-19	Revised 60"x24" sign detail
8-01-24	Electronic Stamp/Signature



08/01/24

ROAD CLOSURE LAYOUTS

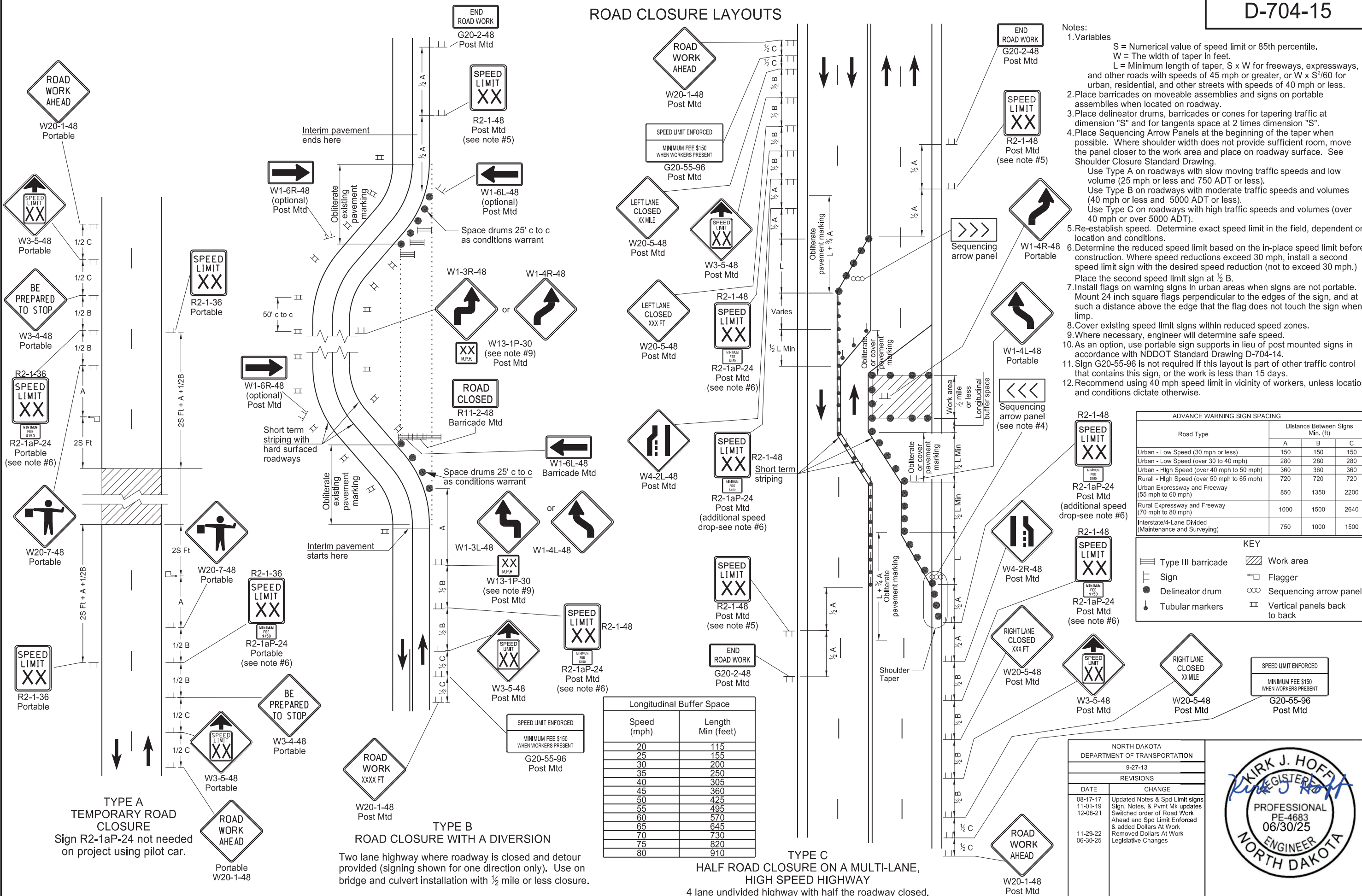

- Notes:
- Variables
 - S = Numerical value of speed limit or 85th percentile.
 - W = The width of taper in feet.
 - L = Minimum length of taper, S x W for freeways, expressways, and other roads with speeds of 45 mph or greater, or W x S²/60 for urban, residential, and other streets with speeds of 40 mph or less.
 - Place barricades on moveable assemblies and signs on portable assemblies when located on roadway.
 - Place delineator drums, barricades or cones for tapering traffic at dimension "S" and for tangents space at 2 times dimension "S".
 - Place Sequencing Arrow Panels at the beginning of the taper when possible. Where shoulder width does not provide sufficient room, move the panel closer to the work area and place on roadway surface. See Shoulder Closure Standard Drawing.
 - Use Type A on roadways with slow moving traffic speeds and low volume (25 mph or less and 750 ADT or less).
 - Use Type B on roadways with moderate traffic speeds and volumes (40 mph or less and 5000 ADT or less).
 - Use Type C on roadways with high traffic speeds and volumes (over 40 mph or over 5000 ADT).
 - Re-establish speed. Determine exact speed limit in the field, dependent on location and conditions.
 - Determine the reduced speed limit based on the in-place speed limit before construction. Where speed reductions exceed 30 mph, install a second speed limit sign with the desired speed reduction (not to exceed 30 mph.) Place the second speed limit sign at 1/2 B.
 - Install flags on warning signs in urban areas when signs are not portable. Mount 24 inch square flags perpendicular to the edges of the sign, and at such a distance above the edge that the flag does not touch the sign when limp.
 - Cover existing speed limit signs within reduced speed zones.
 - Where necessary, engineer will determine safe speed.
 - As an option, use portable sign supports in lieu of post mounted signs in accordance with NDDOT Standard Drawing D-704-14.
 - Sign G20-55-96 is not required if this layout is part of other traffic control that contains this sign, or the work is less than 15 days.
 - Recommend using 40 mph speed limit in vicinity of workers, unless location and conditions dictate otherwise.

Road Type	Distance Between Signs Min. (ft)		
	A	B	C
Urban - Low Speed (30 mph or less)	150	150	150
Urban - Low Speed (over 30 to 40 mph)	280	280	280
Urban - High Speed (over 40 mph to 50 mph)	360	360	360
Rural - High Speed (over 50 mph to 65 mph)	720	720	720
Urban Expressway and Freeway (55 mph to 60 mph)	850	1350	2200
Rural Expressway and Freeway (70 mph to 80 mph)	1000	1500	2640
Interstate/4-Lane Divided (Maintenance and Surveying)	750	1000	1500

Speed (mph)	Length Min (feet)
20	115
25	155
30	200
35	250
40	305
45	360
50	425
55	495
60	570
65	645
70	730
75	820
80	910

NORTH DAKOTA DEPARTMENT OF TRANSPORTATION	
9-27-13	
REVISIONS	
DATE	CHANGE
08-17-17	Updated Notes & Spd Limit signs
11-01-19	Sign, Notes, & Pmnt Mk updates
12-08-21	Switched order of Road Work Ahead and Spd Limit Enforced & added Dollars At Work
11-29-22	Removed Dollars At Work
06-30-25	Legislative Changes



TERMINAL AND SEAL COAT SIGN LAYOUTS

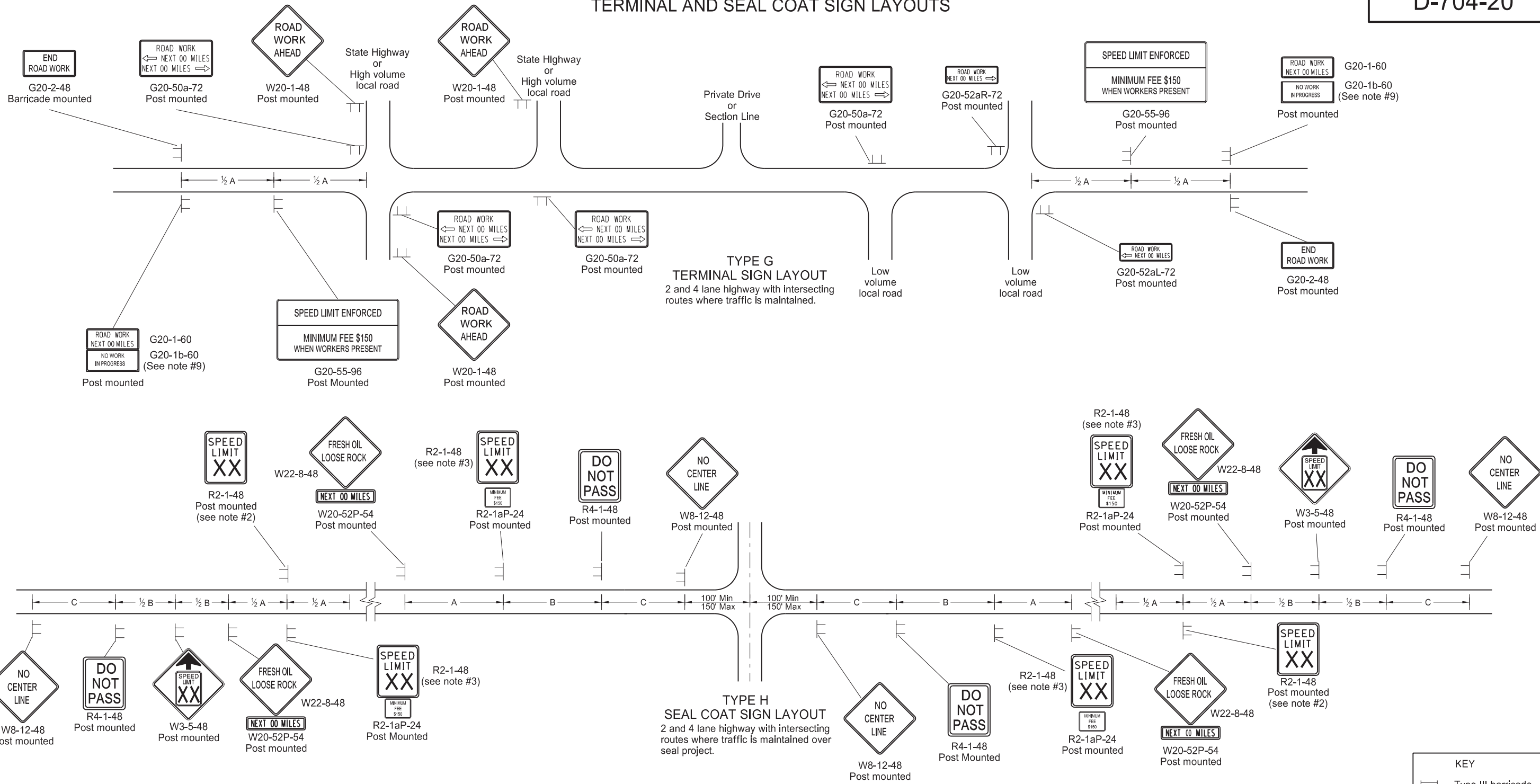

**TYPE G
TERMINAL SIGN LAYOUT**
2 and 4 lane highway with intersecting routes where traffic is maintained.

**TYPE H
SEAL COAT SIGN LAYOUT**
2 and 4 lane highway with intersecting routes where traffic is maintained over seal project.

KEY

- ≡ Type III barricade
- ≡ Sign

- Notes:**
- Place barricades on moveable assemblies and signs on portable assemblies when located on roadway.
 - Determine the exact speed limit in the field, based on location and conditions.
 - Determine the reduced speed limit based on the in place speed limit before construction. Where speed limit reductions exceed 30 MPH, install a second speed limit sign with the desired speed reduction (not to exceed 30 MPH.) Place the second speed limit sign at 1/2 B.
 - Install flags on warning signs in urban areas when signs are not portable. Mount 24 inch square flags perpendicular to the edges of the sign, and at such a distance above the edge that the flag does not touch the sign when limp.
 - Cover existing speed limit signs within a reduced speed zone.
 - On seal coat projects, place signs R2-1-48, R2-1aP-24, R4-1-48, W22-8-48 and W20-52P-54 after all important intersections and at five mile intervals. Place sign W8-12-48 after all important intersections and at 2 mile intervals until short term center line pavement marking is placed.
 - As an option, use portable sign supports in lieu of post mounted signs in accordance with the NDDOT Standard Drawing D-704-14.
 - Cover or remove speed limit signs from layout Type H when loose aggregate is removed.
 - Install sign G20-1b-60 when work is suspended for winter.
 - Use other traffic control layouts in immediate work areas. Place sign R2-1aP-24 below speed limit signs in reduced speed limit work areas.
 - Sign G20-55-96 is not required if this layout is part of other traffic control that contains this sign, or the work is less than 15 days.
 - Recommend using 40 mph speed limit in vicinity of workers, unless location and conditions dictate otherwise.

ADVANCE WARNING SIGN SPACING			
Road Type	Distance Between Signs Min. (ft)		
	A	B	C
Urban - Low Speed (30 mph or less)	150	150	150
Urban - Low Speed (over 30 to 40 mph)	280	280	280
Urban - High Speed (over 40 mph to 50 mph)	360	360	360
Rural - High Speed (over 50 mph to 65 mph)	720	720	720
Urban Expressway and Freeway (55 mph to 60 mph)	850	1350	2200
Rural Expressway and Freeway (70 mph to 80 mph)	1000	1500	2640
Interstate/4-Lane Divided (Maintenance and Surveying)	750	1000	1500

NORTH DAKOTA DEPARTMENT OF TRANSPORTATION	
9-27-13	
REVISIONS	
DATE	CHANGE
08-17-17	Updated notes & sign numbers
11-01-19	Updated note & sign
12-08-21	Switched order of Road Work and Spd Limit Enforced & added Dollars At Work
11-29-22	Removed Dollars At Work
06-30-25	Legislative Changes



D-704-22

CONSTRUCTION TRUCK AND TEMPORARY DETOUR LAYOUTS

KEY

- Type III barricade
- Sign
- Work area
- Flagger

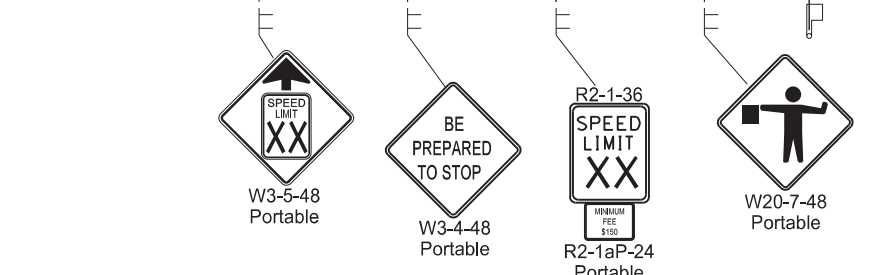
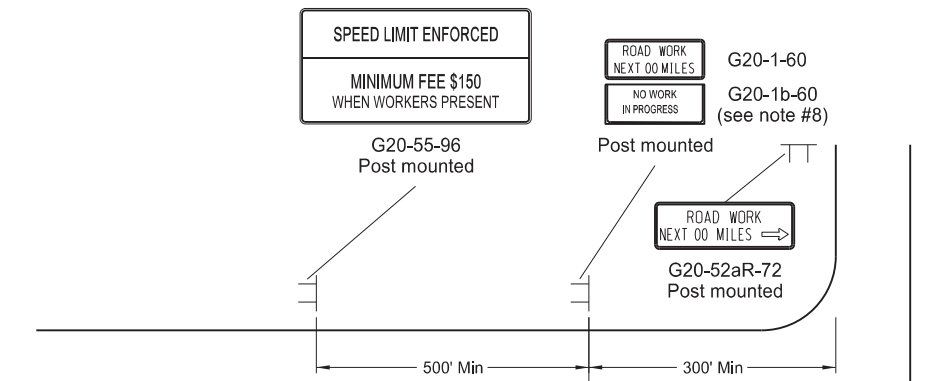
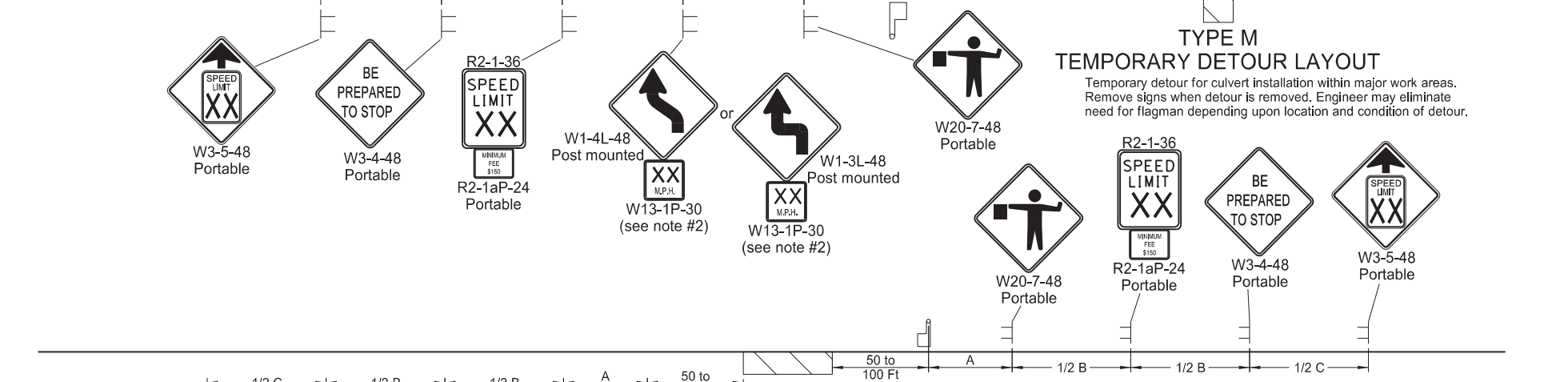
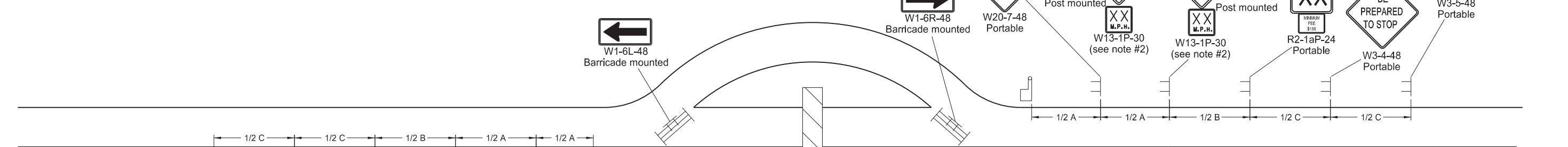
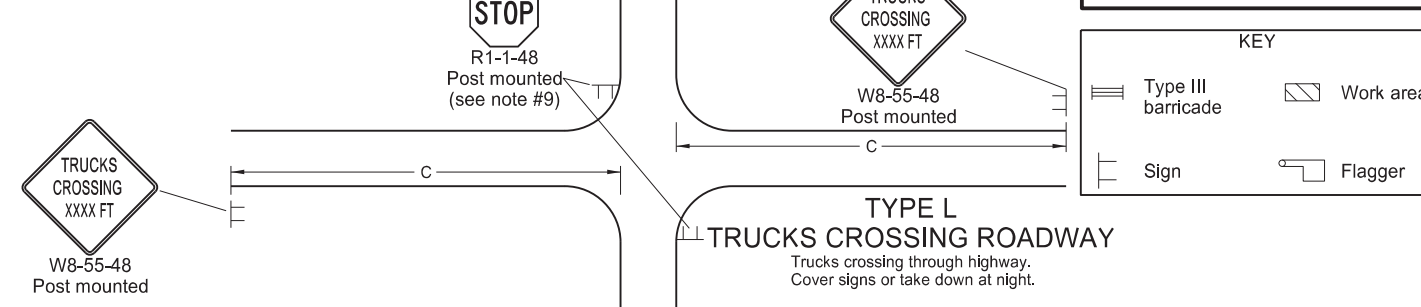
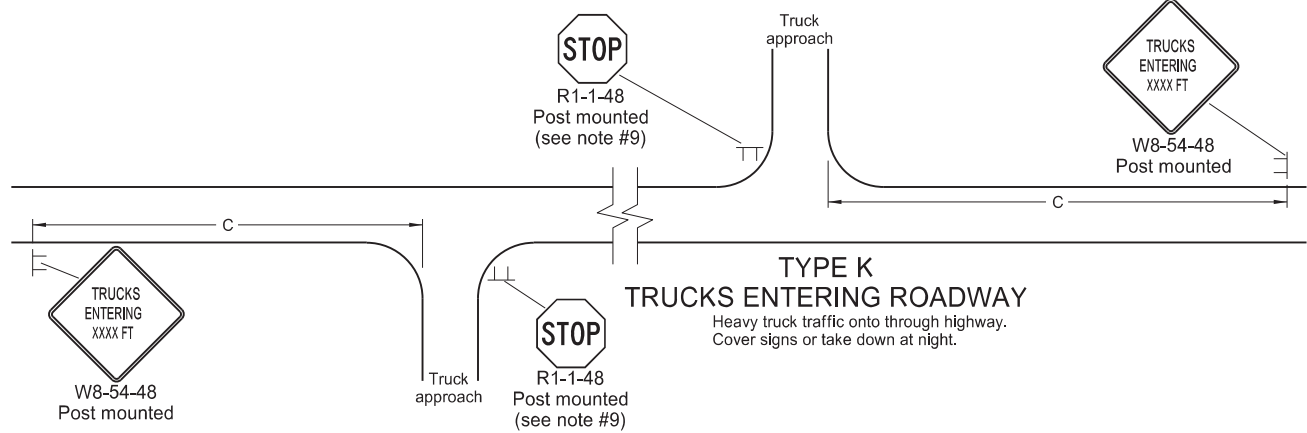

- Notes:
- Place barricades on a moveable assemblies and signs on portable assemblies when located on roadway.
 - Where necessary, safe speed to be determined by the Engineer.
 - Determine the reduced speed limit based on the in-place speed limit before construction. Where speed reductions exceed 30 mph, install a second speed limit sign with the desired speed reduction (not to exceed 30 mph.) Place the second speed limit sign at 1/2 B.
 - Install flags on warning signs in urban areas when signs are not portable. Mount 24 inch square flags perpendicular to the edges of the sign, and at such a distance above the edge that the flag does not touch the sign when limp.
 - Cover existing speed limit signs within a reduced speed zone.
 - Covered (when approved by engineer) or obliterated pavement marking measured as Obliteration of Pavement Marking.
 - As an option, use portable sign supports in lieu of post mounted signs in accordance with NDDOT Standard Drawing D-704-14.
 - Install sign G20-1b-60 when work is suspended for winter.
 - If existing stop sign is in place, a 48" stop sign is not required.
 - Sign G20-55-96 is not required if layout is part of other traffic control that contains this sign, or if work is less than 15 days.
 - Recommend using 40 mph speed limit in vicinity of workers, unless location and conditions dictate otherwise.

Road Type	Distance Between Signs Min. (ft)		
	A	B	C
Urban - Low Speed (30 mph or less)	150	150	150
Urban - Low Speed (over 30 to 40mph)	280	280	280
Urban - High Speed (over 40 mph to 50 mph)	360	360	360
Rural - High Speed (over 50 mph to 65 mph)	720	720	720
Urban Expressway and Freeway (55 mph to 60 mph)	850	1350	2200
Rural Expressway and Freeway (70 mph to 80 mph)	1000	1500	2640
Interstate/4-Lane Divided (Maintenance and Surveying)	750	1000	1500

NORTH DAKOTA DEPARTMENT OF TRANSPORTATION	
9-27-13	
REVISIONS	
DATE	CHANGE
08-17-17	Update notes & sign numbers
11-01-19	Revised sign numbers & note 7
12-09-21	Added Speed Limit Enforced and Dollars At Work signs
11-29-22	Removed Dollars At Work
06-30-25	Legislative Changes



MISCELLANEOUS SIGN LAYOUTS

D-704-26

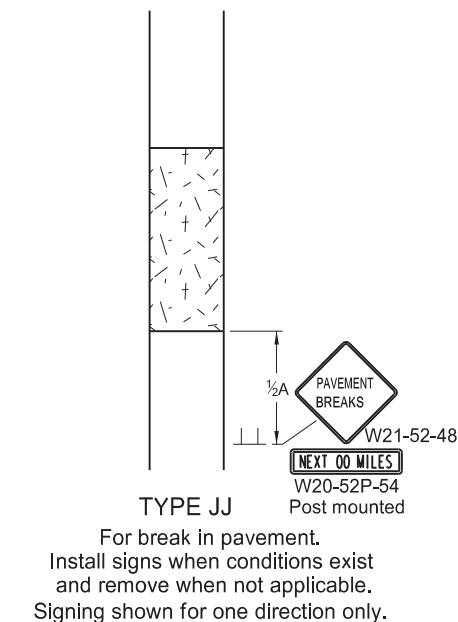
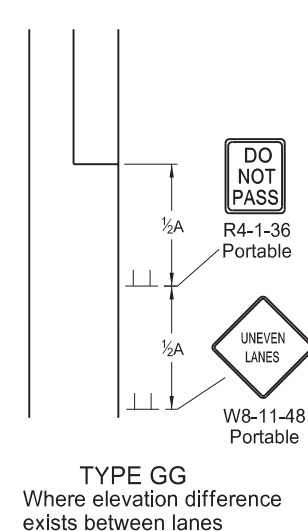
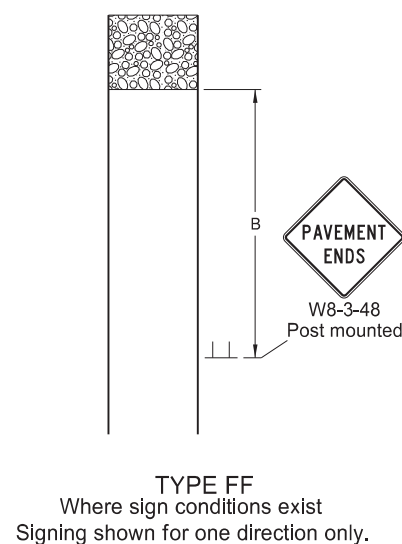
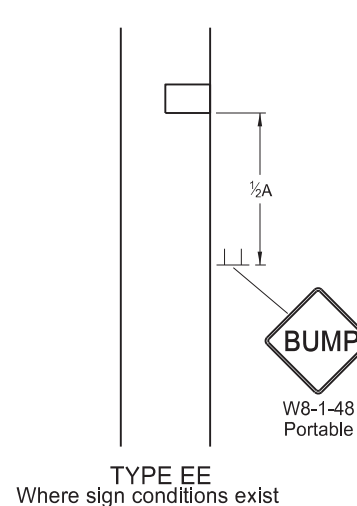
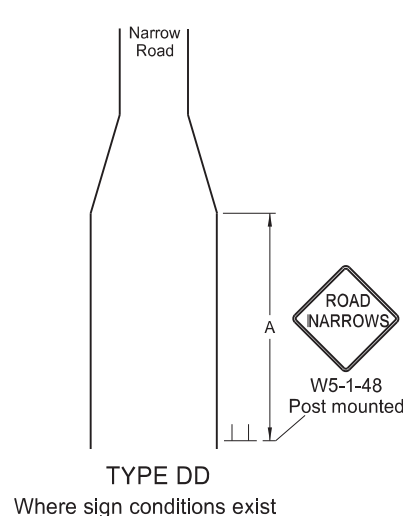
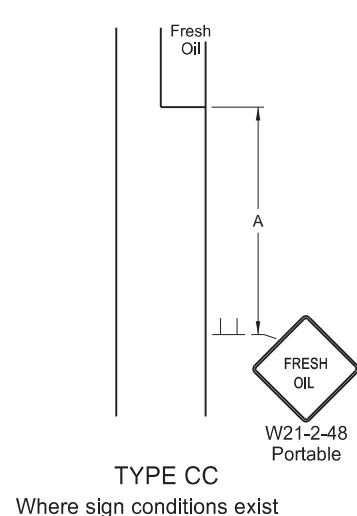
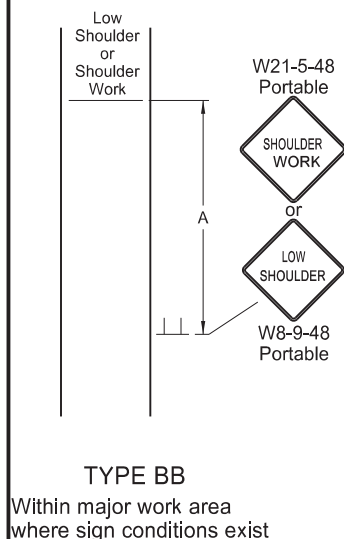
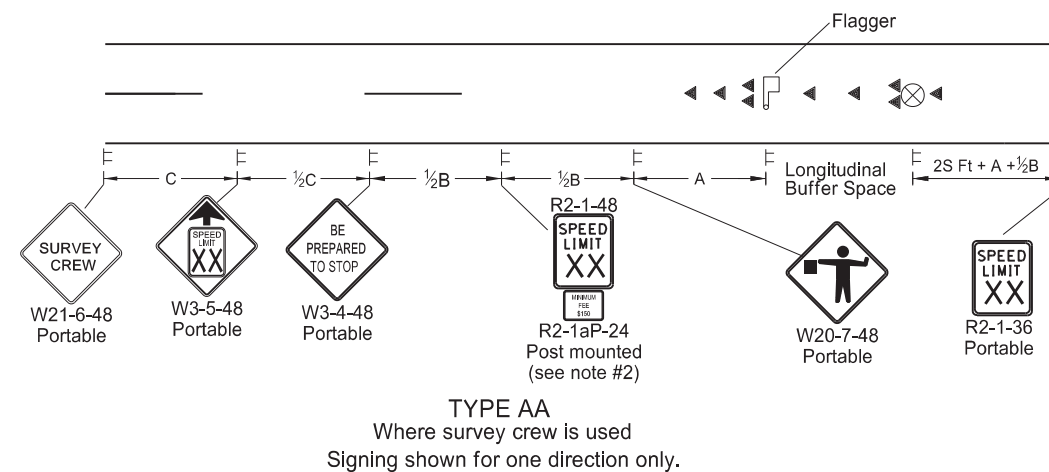
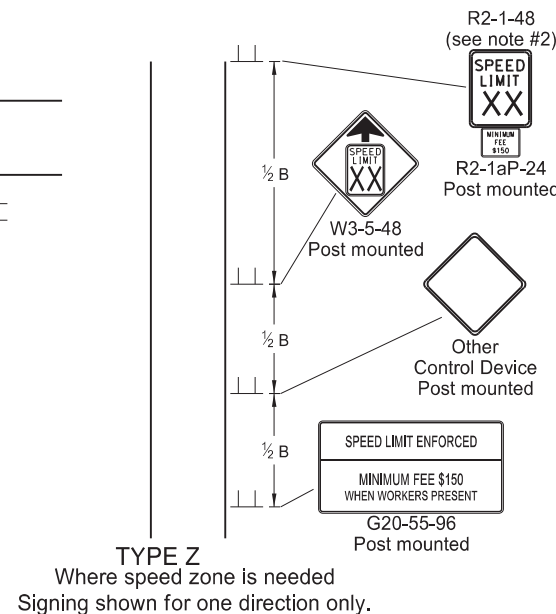
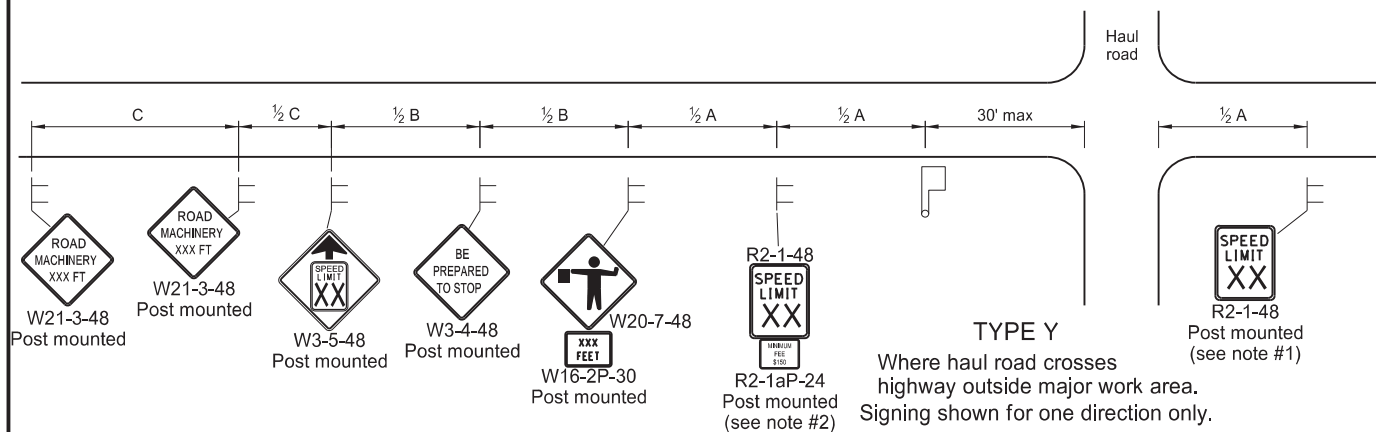

KEY

- Flagger
- Sign
- Cones
- Survey Equipment

S = Numerical value of speed limit or 85th percentile.

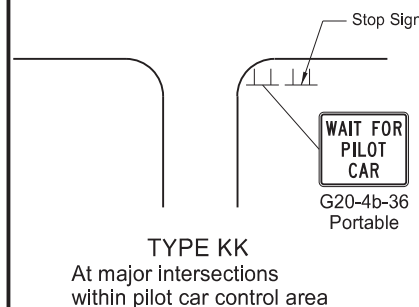

- Notes**
- Re-establish speed limit. Determine exact speed limit in the field, dependent on location and conditions.
 - Determine reduced speed limit based on in-place speed limit before construction. Where speed reductions exceed 30 mph, install a second speed limit sign with the desired speed reduction (not to exceed 30 mph.) Place the second speed limit sign at 1/2B.
 - Install flags on warning signs in urban areas when signs are not portable. Mount 24 inch square flags perpendicular to the edges of the sign, and at such a distance above the edge that the flag does not touch the sign when limp.
 - Cover existing speed limit signs within reduced speed zones.
 - As an option, use portable sign supports in lieu of post mounted signs in accordance with NDDOT Standard Drawing D-704-14.
 - Sign G20-55-96 is not required if this standard is part of other traffic control layouts, or work is less than 15 days.
 - When pilot car operation is used, place sign G20-4b-36 "Wait For Pilot Car" at major intersections within pilot car control area.
 - Recommend 40 mph speed limit in vicinity of workers, unless location and conditions dictate otherwise.
 - Layouts shown for one direction only.

ADVANCE WARNING SIGN SPACING			
Road Type	Distance Between Signs Min. (ft)		
	A	B	C
Urban - Low Speed (30 mph or less)	150	150	150
Urban - Low Speed (over 30 to 40 mph)	280	280	280
Urban - High Speed (over 40 mph to 50 mph)	360	360	360
Rural - High Speed (over 50 mph to 65 mph)	720	720	720
Urban Expressway and Freeway (65 mph to 60 mph)	850	1350	2200
Rural Expressway and Freeway (70 mph to 80 mph)	1000	1500	2640
Interstate/4-Lane Divided (Maintenance and Surveying)	750	1000	1500

Longitudinal Buffer Space	
*Speed (mph)	Length Min (feet)
20	115
25	155
30	200
35	250
40	305
45	360
50	425
55	495
60	570
65	645
70	730
75	820
80	910

* Posted speed, off-peak 85th percentile speed prior to work starting, or the anticipated operating speed in mph.

NORTH DAKOTA DEPARTMENT OF TRANSPORTATION	
9-27-13	
REVISIONS	
DATE	CHANGE
08-17-17	Added speed limit signs. Updated notes & sign numbers
11-01-19	Revised note 5 & sign numbers
02-23-23	Revised distance & removed signs
06-30-25	Legislative Changes



MOBILE OPERATION
(PAVEMENT MARKING)

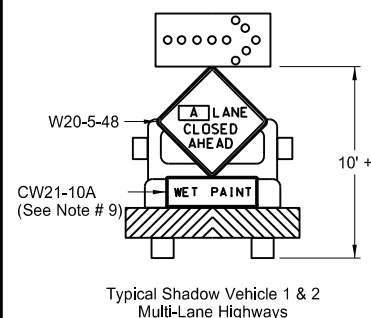
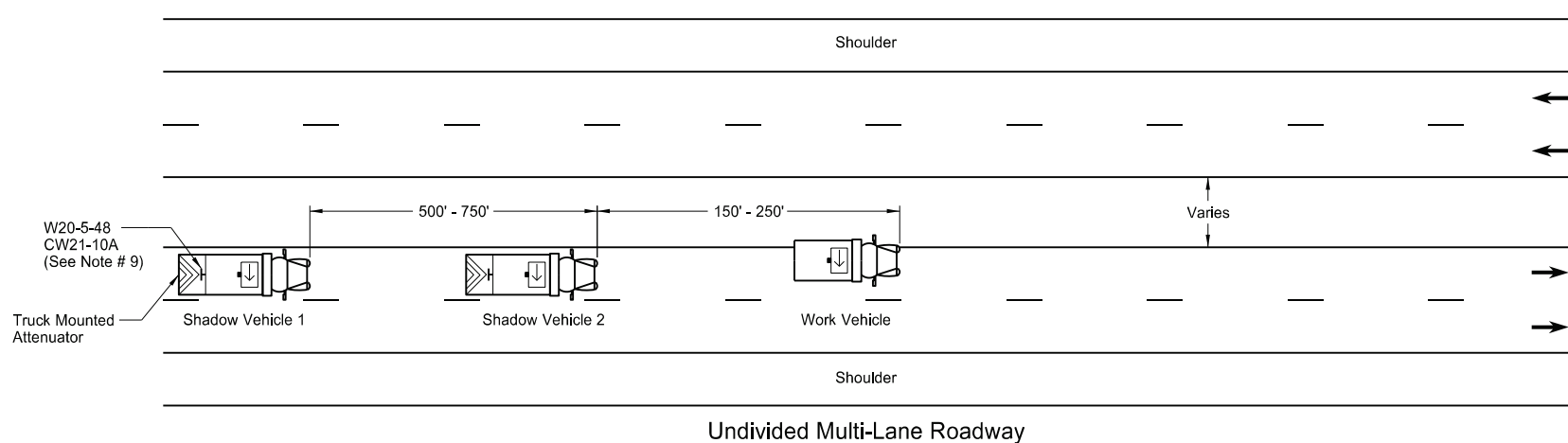
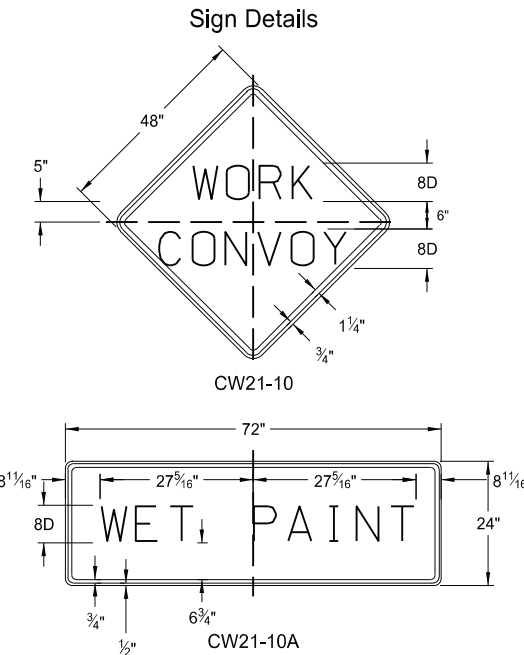
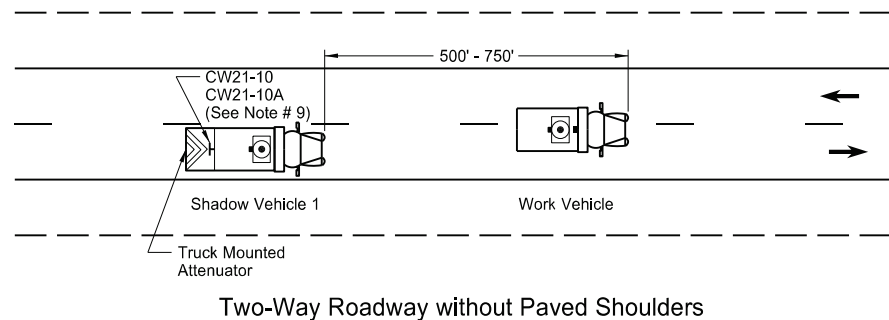
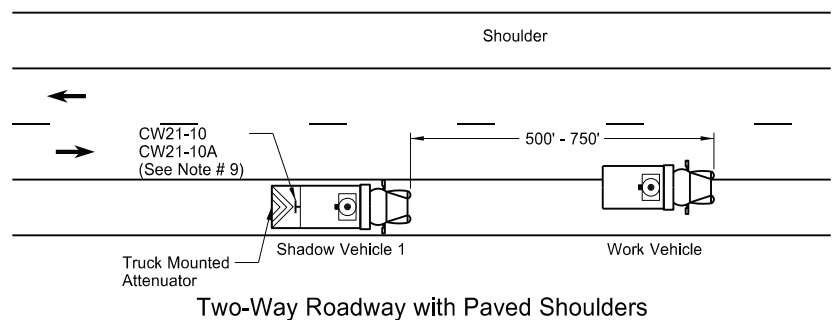
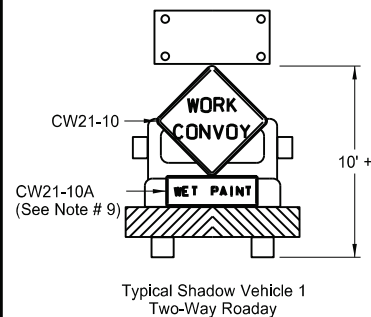

A = Left Right Center

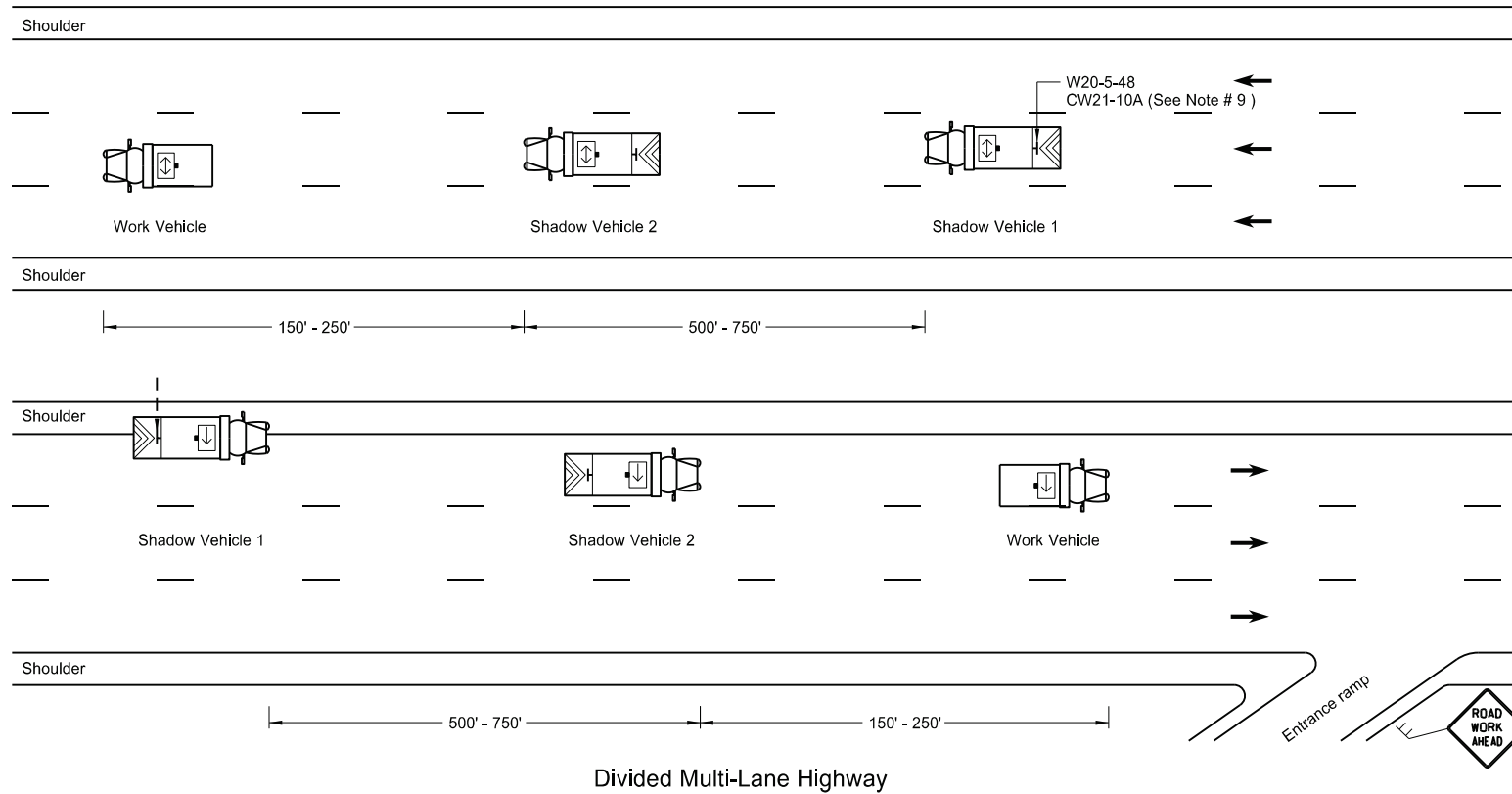

- Notes
1. Use additional vehicles you choose to be in the convoy with truck mounted attenuators, at your own expense.
 2. Display yellow rotating beacons or strobe lights on shadow and work vehicles, unless otherwise stated in the plans.
 3. Use Type B or Type C flashing arrow panels controlled from inside the vehicle.
 4. Provide each vehicle with two-way electronic communication capability.
 5. Move shadow vehicle 1 first to shadow other convoy vehicles when convoy changes lane.
 6. Vary vehicle spacing between shadow vehicle 1 and shadow vehicle 2 based on sight distance restrictions. Motorists approaching the work convoy need to see trail vehicle in time to slow down and/or change lanes as they approach shadow vehicle.
 7. Sign Colors
Letters = Black
Border = Black
Background = Orange
 8. As an option, use shadow vehicle 2 the paint tender vehicle.
 9. Use sign CW21-10A only during painting operation.
 10. Pull over work and shadow vehicles periodically to allow motor vehicle traffic to pass on two lane - two way roadways.

KEY

- Sign
- Truck mounted attenuator
- Flashing arrow panels:
 - Right directional
 - Left directional
 - Double arrow directional
 - Caution Mode

NORTH DAKOTA DEPARTMENT OF TRANSPORTATION	
9-27-13	
REVISIONS	
DATE	CHANGE
6-18-14	Removed shadow vehicle 2 on two lane roadways
9-27-17	Updated to active voice
11-08-19	Changed Standard Heading
8-02-24	Electronic Stamp/Signature.

KIRK J. HOFF
REGISTERED
PROFESSIONAL
PE-4683
ENGINEER
NORTH DAKOTA

08/02/24

PORTABLE SIGN SUPPORT ASSEMBLY

D-704-50

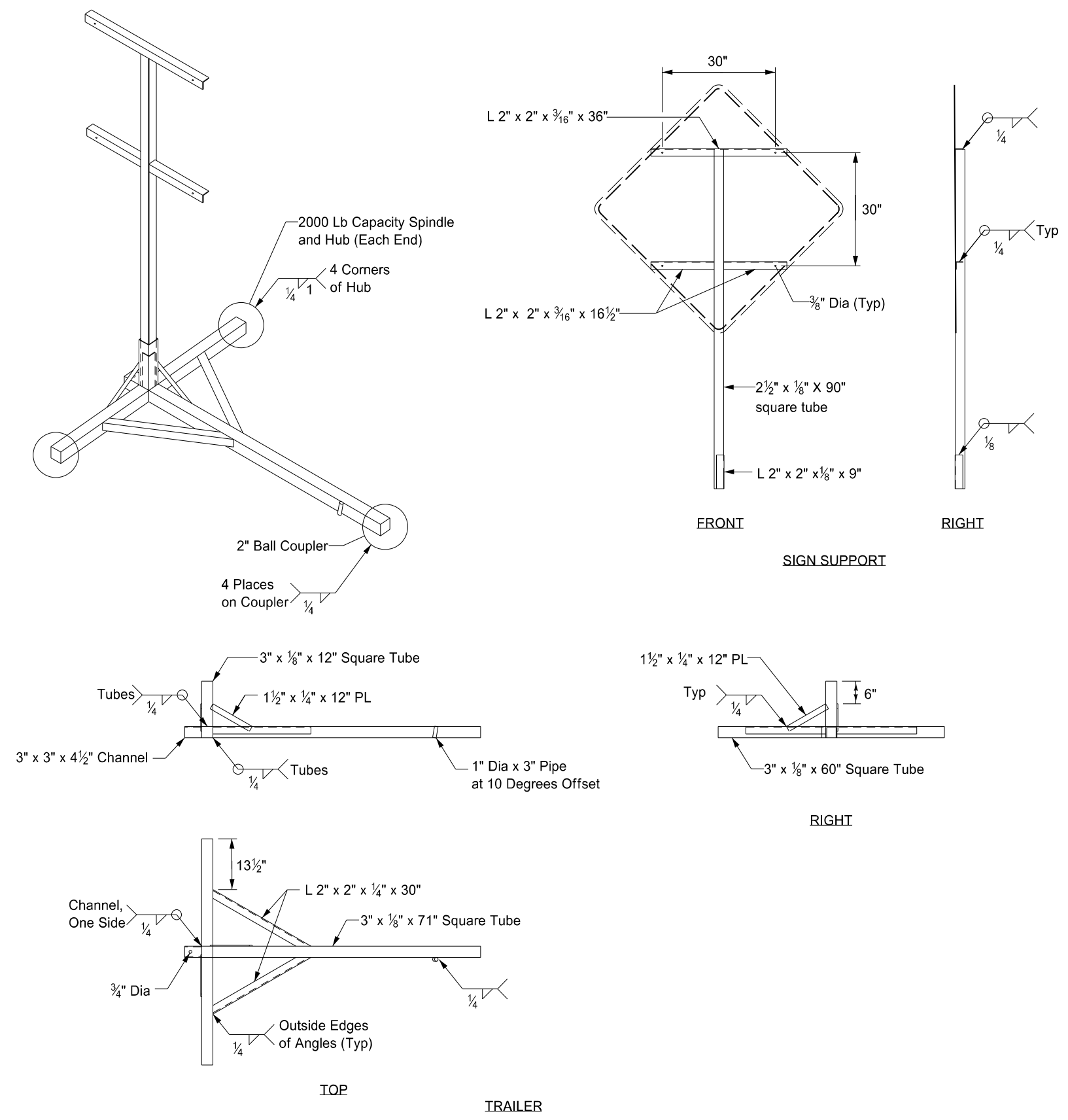

Notes:

- ① Maximum 250 pound weight of assembly.
- ② Use a 14" wheel and tire.
- ③ Use no automotive and equipment axle assemblies for trailer-mounted sign supports.
- ④ Other NCHRP 350 or MASH crash tested assemblies are acceptable.

NORTH DAKOTA DEPARTMENT OF TRANSPORTATION	
11-23-10	
REVISIONS	
DATE	CHANGE
12/02/2020	Updated Note to active voice.

SAW SLOTTED RUMBLE STRIPS AT INTERSECTIONS

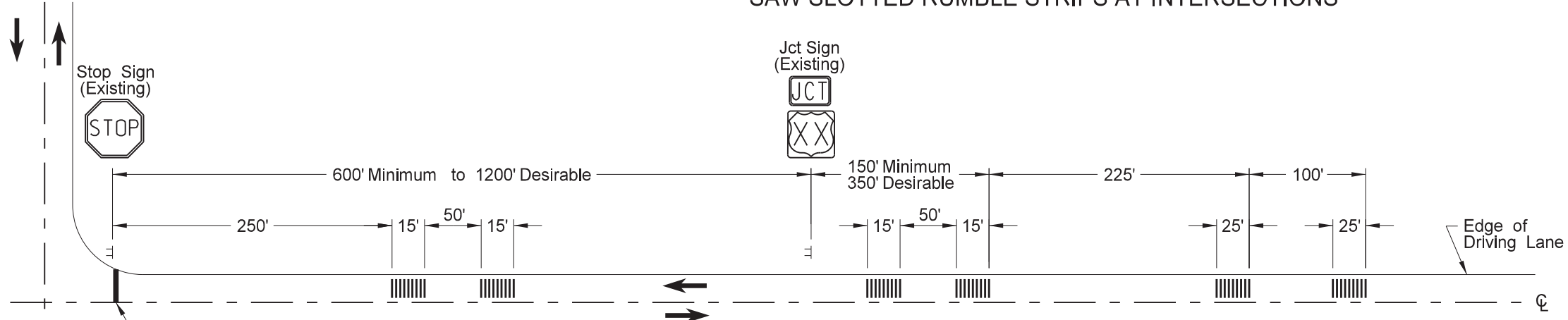

TYPICAL STOP INTERSECTION SAW SLOTTED RUMBLE STRIP LOCATION

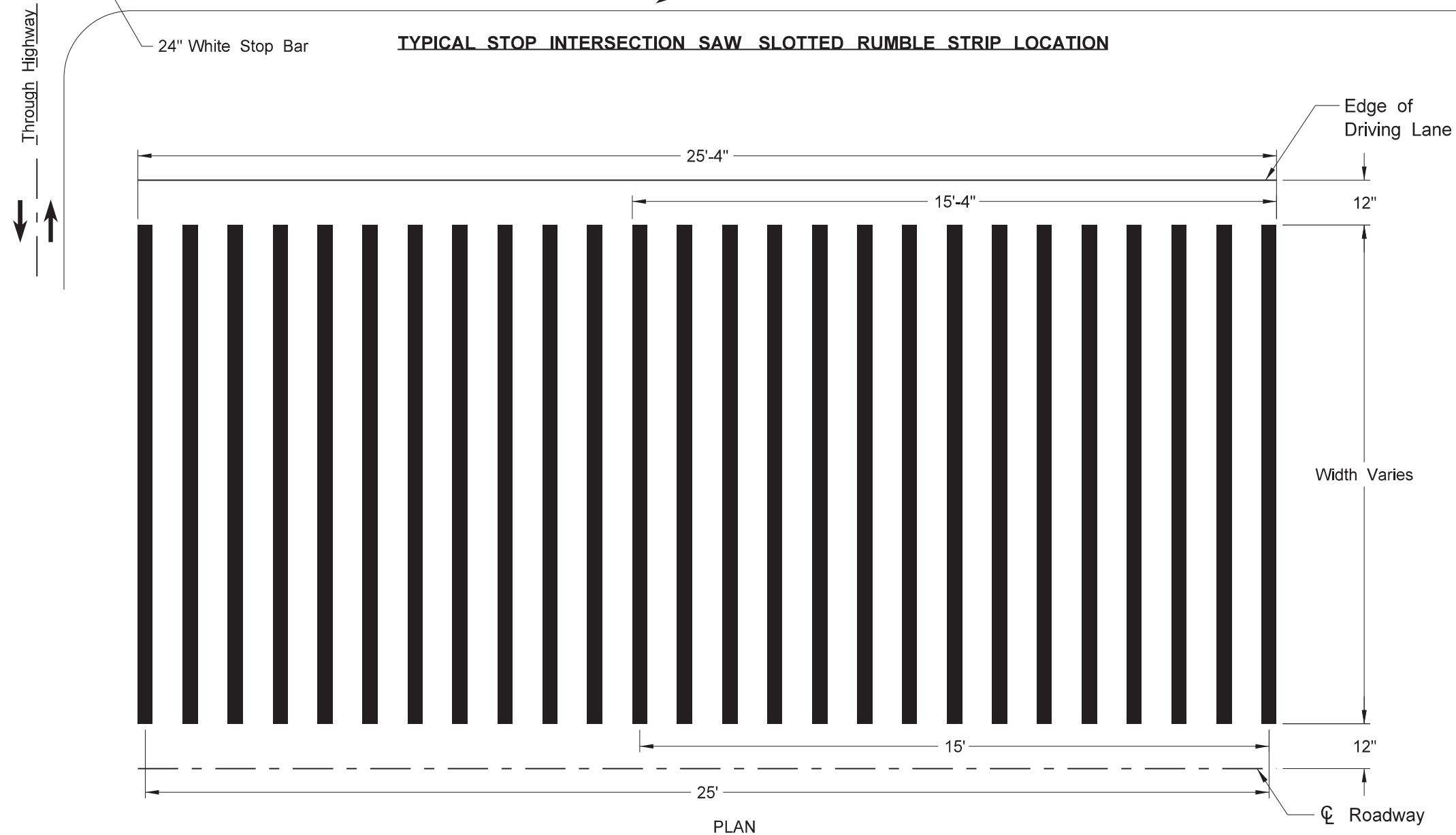

PLAN

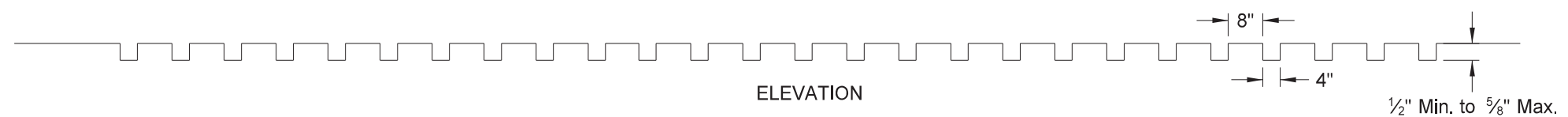

ELEVATION

SAW SLOTTED RUMBLE STRIP DETAIL

NORTH DAKOTA DEPARTMENT OF TRANSPORTATION	
12-29-09	
REVISIONS	
DATE	CHANGE
2-22-10	Saw Slotted width revised.
2-25-10	Note 7 was added.
9-08-11	Revised Notes and D-760-5.
7-07-14	Deleted Notes.
8-27-19	New Design Engr PE Stamp.
8-09-24	Electronic Stamp/Signature.



08/09/24

PAVEMENT MARKING

D-762-4

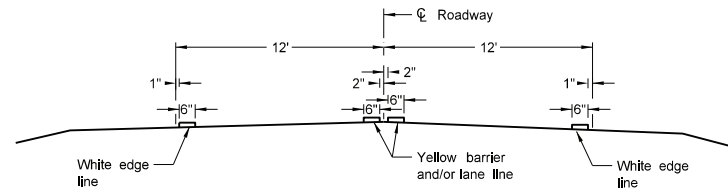

Two Lane Two Way
RURAL ROADWAY

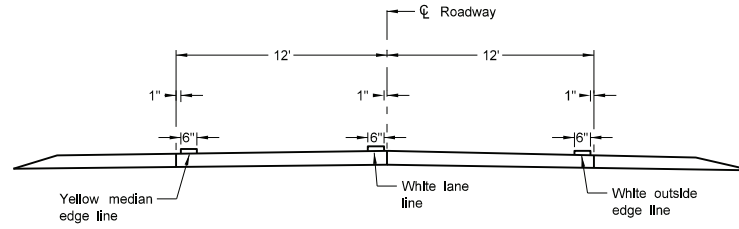

Two Lane Roadway
INTERSTATE HIGHWAY
Concrete Section

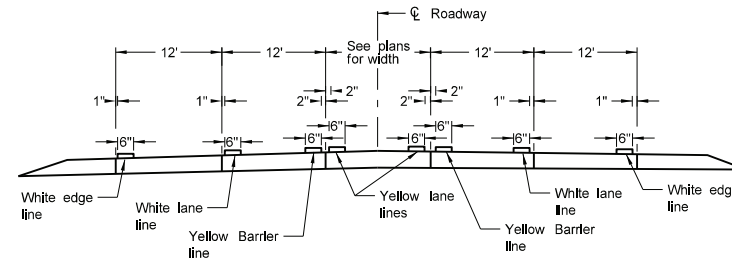

RURAL FIVE LANE ROADWAY
Concrete Section

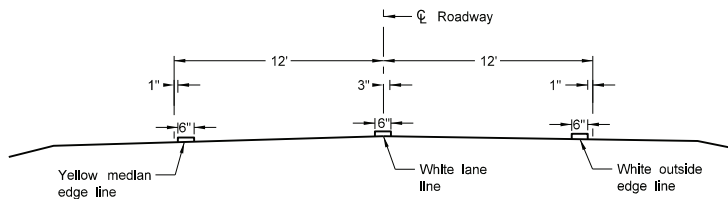

Two Lane Divided
Rural Roadway
PRIMARY HIGHWAY
Asphalt Section

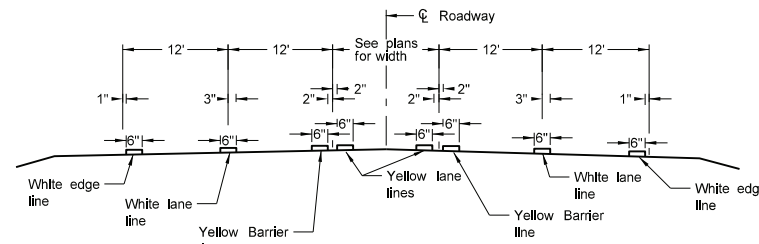

RURAL FIVE LANE ROADWAY
Asphalt Section

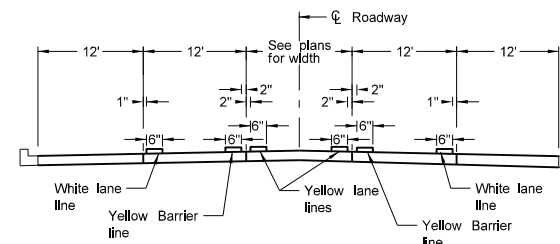

URBAN FIVE LANE SECTION
Concrete Section

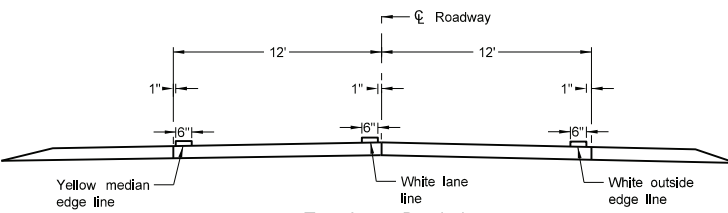

Two Lane Divided
Rural Roadway
PRIMARY HIGHWAY
Concrete Section

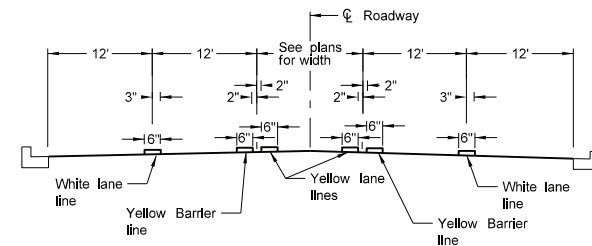

URBAN FIVE LANE SECTION
Asphalt Section

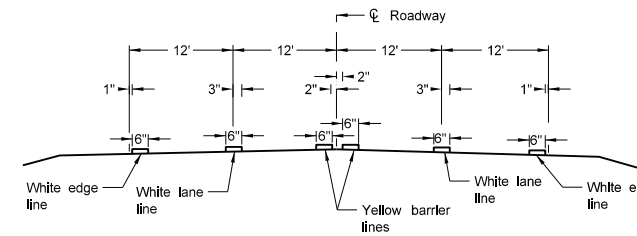

RURAL FOUR LANE ROADWAY
Asphalt Section

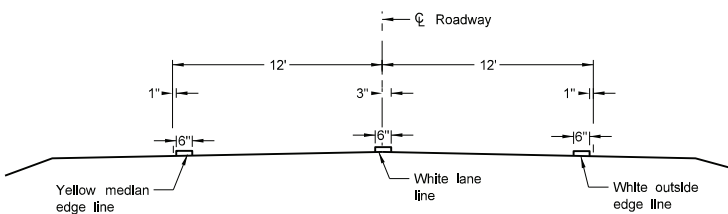

Two Lane Roadway
INTERSTATE HIGHWAY
Asphalt Section

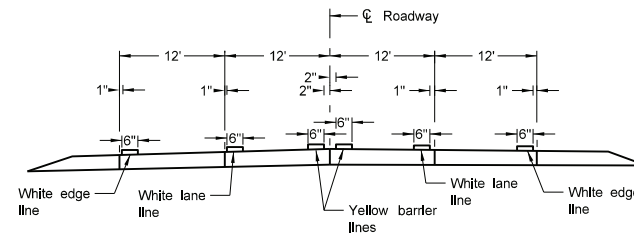

RURAL FOUR LANE ROADWAY
Concrete Section

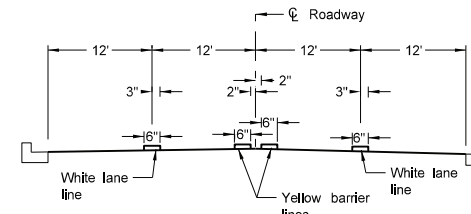

URBAN FOUR LANE SECTION
Asphalt Section

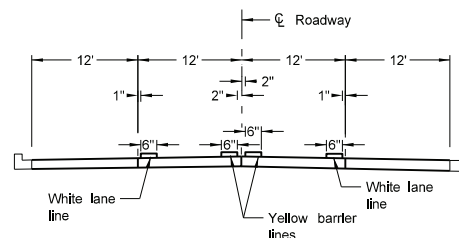

URBAN FOUR LANE SECTION
Concrete Section

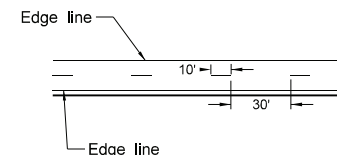

CENTERLINE PAVEMENT MARKING SKIP SPACING DETAIL

NOTES:

1. Continue edge lines through private drives and field drives. Break edge lines for intersections.

For section lines, county roads, and street approaches, stripe the radii and edge lines of the paved surface within the right of way except where curb and gutter is present.
2. Normal width line - 6 inches wide for freeways, expressways, and ramps; 6 inches for all other roadways with speed limits > 40 mph,
3. Use 4 or 6 inch wide pavement marking for all other roadways with speed limits < 40 mph.

NORTH DAKOTA DEPARTMENT OF TRANSPORTATION	
12-1-10	
REVISIONS	
DATE	CHANGE
10-17-17	Updated to active voice.
08-27-19	New Design Engineer PE Stamp.
11-22-23	Revised pavement marking widths.
07-09-24	Modified Note 1.



SHORT-TERM PAVEMENT MARKING

D-762-11

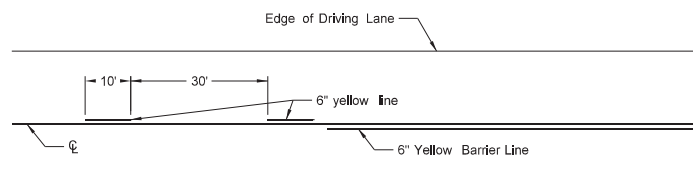

Painted or Tape Lines

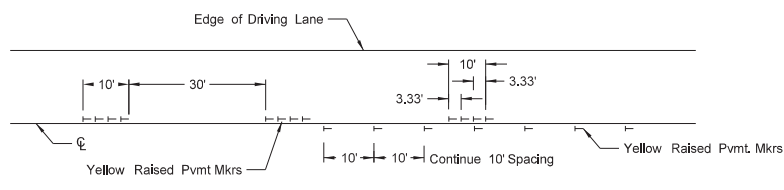

Raised Pavement Markers

TWO-LANE TWO-WAY ROADWAY

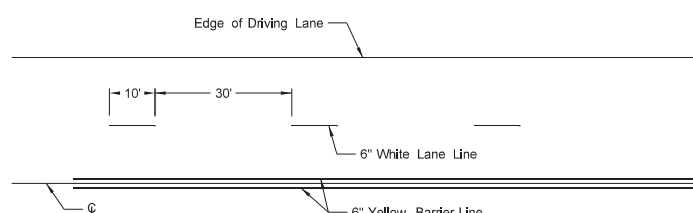

Painted or Tape Lines

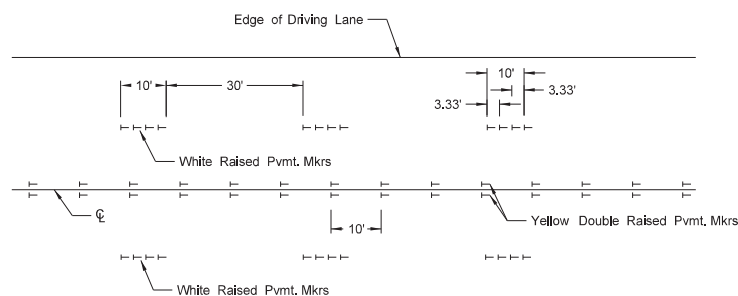

Raised Pavement Markers

FOUR LANE ROADWAY

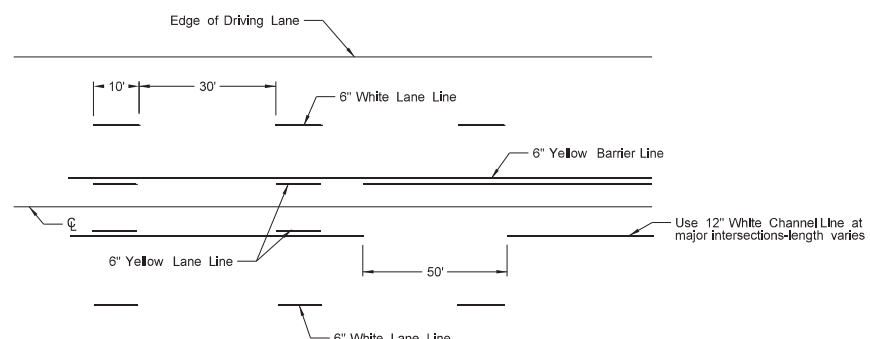

Painted or Tape Lines

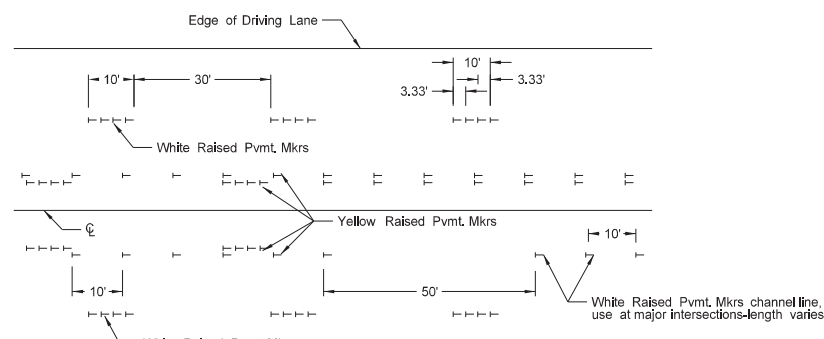

Raised Pavement Markers

FIVE LANE ROADWAY TWO WAY LEFT TURN

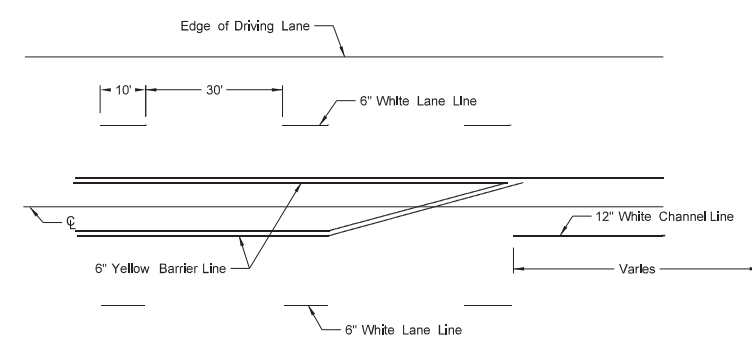

Painted or Tape Lines

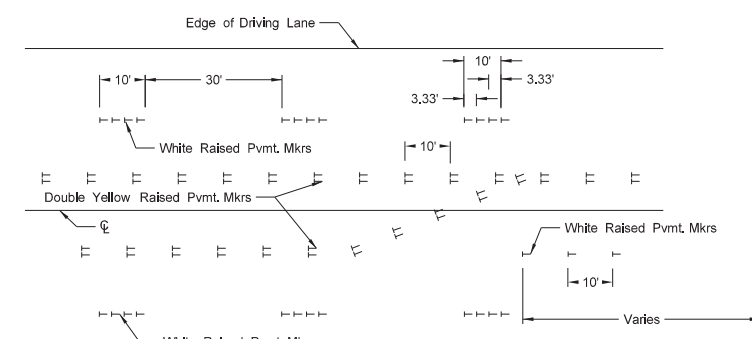

Raised Pavement Markers

FIVE LANE ROADWAY WITH MARKED ISLANDS

NOTES:

1. Place no passing zones on two-lane two-way roadways as shown. In lieu of short term no passing zone pavement markings, place no passing zone signs. Replace no passing zone signs with short term no passing zone pavement marking within three days.
2. Place short term center line stripe (paint) on top lift to match exact placement of permanent stripe.
3. Remove raised markers and tape markings after permanent pavement marking is installed.
4. Normal width line - 6 inches wide for freeways, expressways, and ramps; 6 inches for all other roadways with speed limits > 40 mph.
5. Use 4 or 6 inch wide pavement marking for all other roadways with speed limits ≤ 40 mph.
6. Wide lines - 8 inches wide if 4 inch normal width lines are used and 12 inches wide if 6 inch normal width lines are used.

NORTH DAKOTA DEPARTMENT OF TRANSPORTATION	
12-1-10	
REVISIONS	
DATE	CHANGE
3-29-16	Re-numbered to be D-762-11 (previously was D-762-6)
10-17-17	Updated to active voice.
8-27-19	New Desgn Engineer PE Stamp.
11-22-23	Revised pavement marking widths
1-17-24	Revised wide pvmt marking width.

