

NDDOT ABBREVIATIONS

? This is a special text character used in the labeling of existing features. It indicates a feature that has an unknown characteristic, potentially based on: lack of description, location accuracy or purpose.

Abn abandoned  
 Abut abutment  
 Adj adjusted  
 Aggr aggregate  
 Ahd ahead  
 ARV air release valve  
 Align alignment  
 Al alley  
 Alt alternate  
 Alum aluminum  
 ADA Americans with Disabilities Act  
 & and  
 Appr approach  
 Approx approximate  
 ACP asbestos cement pipe  
 Asph asphalt  
 AC asphalt cement  
 Assmd assumed  
 @ at  
 Atten attenuation  
 ATR automatic traffic recorder  
 Ave Avenue  
 Avg average  
 ADT average daily traffic

C Gdrl cable guardrail  
 Calc calculate  
 CIP cast iron pipe  
 CB catch basin  
 CRS cationic rapid setting  
 C Gd cattle guard  
 C To C center to center  
 CL or ☉ centerline  
 Ch chain  
 Chnlk chain-link  
 Ch Blk channel block  
 Ch Ch channel change  
 Chk check  
 Chsld chiseled  
 Cir circle  
 Cl class  
 Clnt clean-out  
 Clr clear  
 Cl&gr clearing & grubbing  
 Comb. combination  
 Coml commercial  
 Compr compression  
 CADD computer aided drafting & design  
 Conc concrete  
 CECB concrete erosion control blanket  
 Cond conductor  
 Const construction  
 Cont continuous  
 CSB continuous split barrel sample  
 Contr contraction  
 Contr contractor  
 CP control point  
 Coord coordinate  
 Cor corner  
 Corr corrected  
 CAES corrugated aluminum end section  
 CAP corrugated aluminum pipe  
 CMES corrugated metal end section  
 CMP corrugated metal pipe  
 CPVCP corrugated poly-vinyl chloride pipe  
 CSES corrugated steel end section  
 CSFES corrugated steel flared end section  
 CSP corrugated steel pipe  
 CSTES corrugated steel traversable end section  
 Co County  
 Crse course  
 Ct Court  
 Xarm cross arm  
 Xbuck cross buck  
 Xsec cross sections  
 Xing crossing  
 Xrd crossroad  
 Crn crown

Culv culvert  
 C&G curb & gutter  
 CI curb inlet  
 CR curb ramp  
 C cut  
 Dd Ld dead load  
 Defl deflection  
 Defm deformed  
 DInt delineate  
 DIntr delineator  
 Depr depression  
 Desc description  
 Det detail  
 DWP detectable warning panel  
 Dtr detour  
 Dia or ø diameter  
 Dir direction  
 Dist distance  
 DM disturbed material  
 DB ditch block  
 DG ditch grade  
 Dbl double  
 Dn down  
 Dwg drawing  
 Dr drive  
 Drwy driveway  
 DI drop inlet  
 D dry density  
 Ea each  
 Esmt easement  
 E East  
 EB Eastbound  
 Elast elastomeric  
 EL electric locker  
 E Mtr electric meter  
 EVSE electric vehicle supply equipment  
 Elec electric/al  
 EDM electronic distance meter  
 Elev or El elevation  
 Ellipt elliptical  
 Emb embankment  
 Emuls emulsion/emulsified  
 ES end section  
 Engr engineer  
 ESS environmental sensor station  
 Eq equal  
 Evgr evergreen  
 Exc excavation  
 Exst existing  
 Exp expansion  
 Expy Expressway  
 E external of curve  
 Extru extruded

FOS factor of safety  
 Fed Federal  
 FP feed point  
 Fn fence  
 Fn P fence post  
 FO fiber optic  
 FD field drive  
 F fill  
 FAA fine aggregate angularity  
 FH fire hydrant  
 Fl flange  
 Flrd flared  
 FES flared end section  
 F Bcn flashing beacon  
 FA flight auger sample  
 FL flow line  
 Ftg footing  
 FM force main  
 Fnd found  
 Fdn foundation  
 Frac fractional  
 Frwy freeway  
 Frt front  
 FF front face  
 F Disp fuel dispenser  
 FFP fuel filler pipes  
 FLS fuel leak sensor  
 Furn furnish/ed

Bk back  
 BF back face  
 Balc balcony  
 B Wire barbed wire  
 Barr barricade  
 Btry battery  
 BI beehive inlet  
 Beg begin  
 BG below grade  
 BM bench mark  
 Bkwy bikeway  
 Bit bituminous  
 Blk block  
 BH bore hole  
 Bot bottom  
 Blvd Boulevard  
 Bndry boundary  
 Brkwy breakaway  
 Br bridge  
 Bldg building  
 Bus. business  
 BV butterfly valve  
 Byp bypass

NORTH DAKOTA DEPARTMENT OF TRANSPORTATION	
07-01-14	
REVISIONS	
DATE	CHANGE
04-23-18	General Revisions
09-20-18	General Revisions
12-18-20	General Revisions
08-16-22	General Revisions
04-14-25	General Revisions



NDDOT ABBREVIATIONS

D-101-2

Galv	galvanized	Ln	lane	Obsc	obscure(d)	Qty	quantity
Gar	garage	Lg	large	Ocpd	occupied	Qtr	quarter
Gs L	gas line	Lat	latitude	Ocpy	occupy		
G Reg	gas line regulator	Lt	left	O/s	offset		
GMV	gas main valve	Lens	lenses	OC	on center	Rad or R	radius
G Mtr	gas meter	Lvl	level	C	one dimensional consolidation	RR	railroad
GSV	gas service valve	Lvng	leveling	OC	organic content	Rlwy	railway
GVP	gas vent pipe	Lht	light	Orig	original	Rsd	raised
GV	gate valve	LP	light pole	O To O	out to out	RC	rapid curing
Ga	gauge	Ltg	lighting	OD	outside diameter	Rec	record
Gov	government	Liq	liquid	OH	overhead	Recy	recycle
Grd	graded/grade	LL	liquid limit			RAP	recycled asphalt pavement
Grnd	ground	Loc	location			RPCC	recycled portland cement concrete
GWM	ground water monitor	Long.	longitude	PMT	pad mounted transformer	Ref	reference
Gdrl	guardrail	Lp	loop	Pg	pages	R Mkr	reference marker
Gtr	gutter	LD	loop detector	Pntd	painted	RM	reference monument
		Lum	luminaire	Pr	pair	RP	reference point
				Pnl	panel	Refl	reflectorized
H Plg	H piling			Pk	park	RCB	reinforced concrete box
Hdwl	headwall	Mb	mailbox	PSD	passing sight distance	RCES	reinforced concrete end section
Ht	height	ML	main line	Pvmt	pavement	RCFES	reinforced concrete flared end section
Hel	helical	MH	manhole	Ped	pedestal	RCP	reinforced concrete pipe
HDPE	high density polyethylene	Mkd	marked	Ped	pedestrian	RCPS	reinforced concrete pipe sewer
HM	high mast	Mkr	marker	PPP	pedestrian pushbutton post	RCTES	reinforced concrete traversable end section
HP	high pressure	Mkg	marking	Pen.	penetration	Reinf	reinforcement
HPS	high pressure sodium	MA	mast arm	Perf	perforated	Res	reservation
HTCG	high tension cable guardrail	Matl	material	Per.	perimeter	Res	residence
Hwy	highway	Max	maximum	Perm	permanent	Ret	retaining
Hor	horizontal			PL	pipeline	Rev	reverse
HBP	hot bituminous pavement	Meas	measure	PI	place	Rt	right
HMA	hot mix asphalt	Mdn	median	P&P	plan & profile	R/W	right of way
Hyd	hydrant	MD	median drain	PL	plastic limit	Riv	river
Ph	hydrogen ion content	MC	medium curing	Pl or $\bar{P}$	plate	Rd	road
		MGS	Midwest Guardrail System	Pt	point	Rdbd	road bed
		MM	mile marker	PE	polyethylene	Rdwy	roadway
Id	identification	MP	mile post	PVC	polyvinyl chloride	RWIS	roadway weather information system
Incl	inclinometer tube	Min	minimum	PCC	Portland Cement concrete	Rk	rock
IMH	inlet manhole	Misc	miscellaneous	PP	power pole	Rt	route
ID	inside diameter	Mon	monument	Preempt	preemption		
Inst	instrument	Mnd	mound	Prefab	prefabricated		
Intchg	interchange	Mtbl	mountable	Prfmd or Pref	performed		
Intmdt	intermediate	Mtd	mounted	Prep	preparation		
Intscn	intersection	Mtg	mounting	Press.	pressure		
Inv	invert	Mk	muck	PRV	pressure relief valve		
IP	iron pipe			Prestr	prestressed		
				Pvt	private		
				PD	private drive		
Jt	joint	Neop	neoprene	Prod.	production/produce		
Jct	junction	Ntwk	network	Prog	programmed		
		N	North	Prop.	property		
		NE	Northeast	Ppsd	proposed		
		NW	Northwest	PB	pull box		
		NB	Northbound				
		No. or #	number				

NORTH DAKOTA DEPARTMENT OF TRANSPORTATION	
07-01-14	
REVISIONS	
DATE	CHANGE
08-03-15	General Revisions
04-23-18	General Revisions
12-18-20	General Revisions
08-16-22	General Revisions
04-14-25	General Revisions

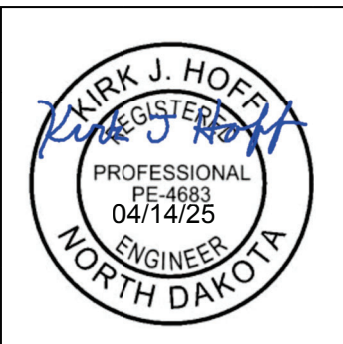

NDDOT ABBREVIATIONS

D-101-3

Salv	salvage(d)	Tel	telephone
San	sanitary sewer line	Tel B	Telephone Booth
Sec	section	Tel P	telephone pole
SL	section line	Tv	television
Sep	separation	Temp	temperature
Seq	sequence	Temp	temporary
Serv	service	TBM	temporary bench mark
Sht	sheet	T	thinwall tube sample
Shtng	sheeting	Ts	topsoil
Shldr	shoulder	Traf	traffic
Sw or Sdwk	sidewalk	TSCB	traffic signal control box
SD	sight distance	Tr	trail
SN	sign number	Transf	transformer
Sig	signal	Trans	transition
Sgl	single	TT	transmission tower
SRCP	slotted reinforced concrete pipe	TES	traversable end section
SC	slow curing	Trans	transverse
SS	slow setting	Trtd	treated
Sm	small	Trmt	treatment
S	South	Qc	triaxial compression
SE	Southeast	TERO	tribal employment rights ordinance
SW	Southwest	Tpl	triple
SB	Southbound	Typ	typical
Sp	spaces		
Spcl	special	Qu	unconfined compressive strength
SA	special assembly	Ugrnd	underground
SP	special provisions	Util	utility
G	specific gravity		
Spk	spike	VG	valley gutter
SB	split barrel sample	Vap	vapor
SH	sprinkler head	Vert	vertical
SV	sprinkler valve	VCP	vitrified clay pipe
Sq	square	Vol	volume
Stk	stake	VSFS	vehicle speed feedback sign
Std	standard		
N	standard penetration test	Wkwy	walkway
Std Specs	standard specifications	W	water content
Stm L	steam line	WGV	water gate valve
SEC	steel encased concrete	WL	water line
SMA	stone matrix asphalt	WM	water main
SSD	stopping sight distance	WMV	water main valve
SD	storm drain	W Mtr	water meter
St	street	WSV	water service valve
SPP	structural plate pipe	WW	water well
SPPA	structural plate pipe arch	Wrng	wearing
Str	structure	WIM	weigh in motion
Subd	subdivision	W	west
Sub	subgrade	WB	westbound
Sub Prep	subgrade preparation	Wrng	wiring
Ss	subsoil	W/	with
SS	supplement specification	W/o	without
Supp	supplemental		
Surf	surfacing		
Surv	survey		
Sym	symmetrical		

NORTH DAKOTA DEPARTMENT OF TRANSPORTATION	
07-01-14	
REVISIONS	
DATE	CHANGE
08-03-15	General Revisions
04-23-18	General Revisions
12-18-20	General Revisions
08-16-22	General Revisions
04-14-25	General Revisions

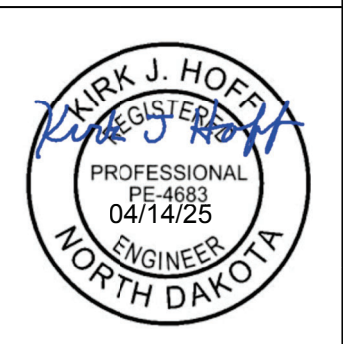

NDDOT ABBREVIATIONS

D-101-4

MEASUREMENTS

ac acres  
 A ampere  
 Bd Ft board feet  
 Cd candela  
 cm centimeter  
 C coulomb  
 CF cubic feet  
 m3 cubic meter  
 m3/s cubic meters per second  
 CY cubic yard  
 CY/mi cubic yards per mile  
 D or Deg degree  
 F Fahrenheit  
 F farad  
 ft feet/foot  
 Gal gallon  
 G giga  
 Ha hectare  
 H henry  
 Hz hertz  
 hr hour(s)  
 in. inch  
 J joule  
 K kelvin  
 kN kilo newton  
 kPa kilo pascal  
 kg kilogram  
 kg/m3 kilogram per cubic meter  
 km kilometer  
 K Kip(s)  
 LF linear foot  
 L litre  
 Lm lumen  
 L sum lump sum  
 Lx lux  
 M Hr man hour  
 M mega  
 m meter  
 m/s meters per second  
 mi mile  
 mL milliliter  
 mm millimeter  
 mm/hr millimeters per hour  
 n nano  
 N newton  
 Pa pascal  
 lb pounds  
 sec seconds  
 S siemens  
 SF square feet  
 km2 square kilometer  
 m2 square meter  
 SY square yard  
 Sta Yd station yards  
 SI Systems International

T tesla  
 T/mi tons per mile  
 V volt  
 W watt  
 Wb weber

SURVEY DESCRIPTIONS

Az azimuth  
 Bs backsight  
 Brg bearing  
 BP Cap blue plastic cap  
 BS both sides  
 BC brass cap  
 CC closing corner  
 CS curve to spiral  
 Eq equation  
 E external of curve  
 FS far side  
 FB field book  
 Fs foresight  
 Geod geodetic  
 GIS Geographical Information System  
 GPS Global Positioning System  
 HI height of instrument  
 IM iron monument  
 I Pn iron pin  
 LS Land Surveyor (licensed)  
 LSIT Land Surveyor In Training  
 L length of curve  
 LC long chord  
 LB level book  
 MC meander corner  
 Mer meridian  
 M mid ordinate of curve  
 NGS National Geodetic Survey  
 NS near side  
 Obsn observation  
 Off Loc office location  
 OP Cap orange plastic cap  
 PK Parker-Kalon nail  
 P Cap plastic cap  
 PP Cap pink plastic cap  
 PCC point of compound curve  
 PC point of curve  
 PI point of intersection  
 PRC point of reverse curvature  
 PT point of tangent  
 POC point on curve  
 POT point on tangent  
 RTP random traverse point  
 Rge range  
 RP Cap red plastic cap  
 SC spiral to curve  
 SC standard corner  
 ST spiral to tangent  
 Sta station  
 SE superelevation  
 Tan tangent  
 T tangent (semi)  
 TS tangent to spiral  
 Twp township  
 TB transit book  
 TP traverse point  
 TP turning point  
 USC&G US Coast & Geodetic Survey  
 USGS US Geologic Survey  
 VC vertical curve  
 WC witness corner  
 WGS World Geodetic System  
 YP Cap yellow plastic cap  
 Z zenith

SOIL TYPES

Cl clay  
 Cl F clay fill  
 Cl Hvy clay heavy  
 Cl Lm clay loam  
 Co S coal slack  
 C Gr coarse gravel  
 CS coarse sand  
 FS fine sand  
 Gr gravel  
 Lig Co lignite coal  
 Lig Sl lignite slack  
 Lm loam  
 Rk rock  
 Sd sand  
 Sdy Cl sandy clay  
 Sdy Cl Lm sandy clay loam  
 Sdy Fl sandy fill  
 Sdy Lm sandy loam  
 Sc scoria  
 Sh shale  
 Si Cl silt clay  
 Si Cl Lm silty clay loam  
 Si Lm silty loam

NORTH DAKOTA DEPARTMENT OF TRANSPORTATION	
07-01-14	
REVISIONS	
DATE	CHANGE
12-18-20	Sheet Added
4-14-25	- Continued from D-101-3 General Revisions

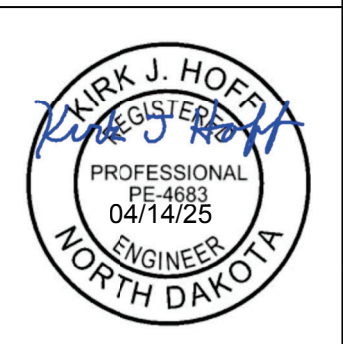

NDDOT UTILITY COMPANY AND ORGANIZATION ABBREVIATIONS

D-101-10

702COM 702 Communications  
 ACCENT Accent Communications  
 AGASSIZ WU Agassiz Water Users District  
 AGC Associated General Contractors of America  
 ALL PL Alliance Pipeline  
 ALL SEAS WU All Seasons Water Users District  
 AMOCO PI Amoco Pipeline Company  
 AMRDA HESS Amerada Hess Corporation  
 AT&T AT&T Corporation  
 B PAW Bear Paw Energy Incorporated  
 BAKER ELEC Baker Electric  
 BASIN ELEC Basin Electric Cooperative Incorporated  
 BEK TEL Bek Communications Cooperative  
 BELLE PL Belle Fourche Pipeline Company  
 BLM Bureau of Land Management  
 BNSF Burlington Northern Santa Fe Railway  
 BOEING Boeing  
 BRNS RWD Barnes Rural Water District  
 BURK-DIV ELEC Burke-Divide Electric Cooperative  
 BURL WRD Burleigh County Water Resource District  
 CABLE ONE Cable One  
 CABLE SERV Cable Services  
 CAP ELEC Capital Electric Cooperative Incorporated  
 CASS CO ELEC Cass County Electric Cooperative  
 CASS RWU Cass Rural Water Users District  
 CAV ELEC Cavalier Rural Electric Cooperative  
 CBLCOM Cablecom Of Fargo  
 CENEX PL Cenex Pipeline  
 CENT PL WATER DIST Central Pipe Line Water District  
 CENT PWR ELEC Central Power Electric Cooperative  
 CENTURYLINK CenturyLink  
 COE Corps of Engineers  
 CONS COMM Consolidated Communications  
 CONS TELCOM Consolidated Telcom  
 CONT RES Continental Resource Inc  
 CPR Canadian Pacific Railway  
 D O E Department Of Energy  
 DAK CARR Dakota Carrier Network  
 DAK CENT TEL Dakota Central Telephone  
 DAK RWD Dakota Rural Water District  
 DGC Dakota Gasification Company  
 DICKEY R NET Dickey Rural Networks  
 DICKEY WRD Dickey County Water Resource District  
 DICKEY TEL Dickey Telephone  
 DNRR Dakota Northern Railroad  
 DOME PL Dome Pipeline Company  
 DVELEC Dakota Valley Electric Cooperative  
 DVMW Dakota, Missouri Valley & Western  
 E CENT REG WD East Central Water District  
 ENBRDG Enbridge Pipelines Incorporated  
 ENVENTIS Enventis Telephone  
 EQUINOR Equinor Pipeline  
 FALK MNG Falkirk Mining Company  
 FHWA Federal Highway Administration  
 G FKS-TRL WD Grand Forks-traill Water District  
 GETTY TRD & TRAN Getty Trading & Transportation  
 GLDN W ELEC Golden West Electric Cooperative

GTR RAMSEY WD Greater Ramsey Water District  
 GT PLNS NAT GAS Great Plains Natural Gas Company  
 HALS TEL Halstad Telephone Company  
 IDEA1 Idea1  
 INT-COMM TEL Inter-Community Telephone Company  
 KANEB PL Kaneb Pipeline Company  
 KEM ELEC Kem Electric Cooperative Incorporated  
 KOCH GATH SYS Koch Gathering Systems Incorporated  
 LKHD PL Lakehead Pipeline Company  
 LWR YELL R ELEC Lower Yellowstone Rural Electric  
 LUMEN Lumen Technologies Incorporated  
 MCKNZ CON McKenzie Consolidated Telcom  
 MCKNZ ELEC McKenzie Electric Cooperative  
 MCKNZ WRD McKenzie County Water Resource District  
 MCLEOD McLeod USA  
 MCLN ELEC McLean Electric Cooperative  
 MCLN-SHRDN R WAT McLean-Sheridan Rural Water District  
 MDU Montana-dakota Utilities  
 MIDCO MidContinent Communications  
 MIDSTATE TEL Midstate Telephone Company  
 MINOT CABLE Minot Cable Television  
 MINOT TEL Minot Telephone Company  
 MISS VALL COMM Missouri Valley Communications Incorporated  
 MISS W W S Missouri West Water System  
 MNKOTA PWR Minnkota Power  
 MOR-GRAN-SOU ELEC Mor-gran-sou Electric Cooperative  
 MOUNT-WILLI ELEC Mountrail-williams Electric Cooperative  
 MLGC Moore & Liberty - Griggs County  
 MUNICIPAL City Water And Sewer  
 MUNICIPAL City Of '.....'  
 N CENT ELEC North Central Electric Cooperative  
 N PRAIR REG WD North Prairie Regional Water District  
 ND PKS & REC North Dakota Parks And Recreation  
 ND TEL North Dakota Telephone Company  
 NDDOT North Dakota Department of Transportation  
 NE REG WD Northeast Regional Water District  
 NDSU SOIL SCI DEPT NDSU Soil Science Department  
 NEMONT TEL Nemont Telephone  
 NODAK R ELEC Nodak Rural Electric Cooperative  
 NOON FRMS TEL Noonan Farmers Telephone Company  
 NPR Northern Plains Railroad  
 NSP Northern States Power  
 NTHN BRDR PL Northern Border Pipeline  
 NTHN PLNS ELEC Northern Plains Electric Cooperative Incorporated  
 NTHWSTRN REF Northwestern Refinery Company  
 NW COMM Northwest Communication Cooperation  
 NWRWD Northwest Rural Water District  
 ONEOK Oneok gas  
 OSHA Occupational Safety and Health Administration  
 OTTR TL PWR Otter Tail Power Company  
 PAAP Plains All American Pipeline  
 P L E M Prairielands Energy Marketing  
 POLAR COM Polar Communications  
 PVT ELEC Private Electric  
 QWEST Qwest Communications  
 R&T REG WD R & T Water District

RED RIV COMM Red River Communications  
 RESVTN TEL Reservation Telephone  
 ROBRTS TEL Roberts Company Telephone  
 R-RIDER ELEC Roughrider Electric Cooperative  
 RRVW Red River Valley & Western Railroad  
 S CENT REG WD South Central Regional Water District  
 SE W U Southeast Water Users Incorporated  
 SCOTT CABLE Scott Cable Television Dickinson  
 SHERDN ELEC Sheridan Electric Cooperative  
 SHEYN VLY ELEC Sheyenne Valley Electric Cooperative  
 SKYTECH Skyland Technologies Incorporated  
 SLOPE ELEC Slope Electric Cooperative Incorporated  
 SOURIS RIV TELCOM Souris River Telecommunications  
 ST WAT COMM State Water Commission  
 STATE LN WATER State Line Water Cooperative  
 STER ENG Sterling Energy  
 STUT RWD Stutsman Rural Water District  
 SW PL PRJ Southwest Pipeline Project  
 SWWA Southwest Water Authority  
 SUNOCO Sunoco LP  
 T M C Turtle Mountain Communications  
 TCI TCI of North Dakota  
 TESORO GHG PLNS PL Tesoro High Plains Pipeline  
 TRI-CNTY WU Tri-County Water Users Incorporated  
 TRL CO WRD Traill County Water Resource District  
 UNTD TEL United Telephone  
 UPPR SOUR WD Upper Souris Water District  
 US SPRINT U.S. Sprint  
 USAF MSL CABLE U.S.A.F. Missile Cable  
 USFWS US Fish and Wildlife Service  
 USW COMM U.S. West Communications  
 VRNDRY ELEC Verendrye Electric Cooperative  
 W RIV TEL West River Telephone Incorporated  
 WAPA Western Area Power Administration  
 WAWSA Western Area Water Supply Authority  
 WEB W. E. B. Water Development Association  
 WILLI WRD Williams County Water Resource District  
 WILSTN BAS PL Williston Basin Interstate Pipeline Company  
 WLSH RWD Walsh Water Rural Water District  
 WOLVRTN TEL Wolverton Telephone  
 XLENER Xcel Energy  
 YSVR Yellowstone Valley Railroad

NORTH DAKOTA DEPARTMENT OF TRANSPORTATION	
07-01-14	
REVISIONS	
DATE	CHANGE
04-23-18	General Revisions
05-20-18	General Revisions
12-18-20	General Revisions
08-16-22	General Revisions
04-14-25	General Revisions



# LINE STYLES

D-101-20

## Existing Topography

- Void - Void - Void - V Existing Ground Void
- Existing Cemetary Boundary
- Existing Box Culvert Bridge
- Existing Concrete Surface
- Existing Drainage Structure
- Existing Gravel Surface
- Existing Riprap
- Existing Dirt Surface
- Existing Asphalt Surface
- Existing Tie Point Line
- Existing Railroad Centerline
- Existing Guardrail Cable
- Existing Guardrail Metal
- Existing Edge of Water
- Existing Fence
- Existing Railroad
- Existing Field Line
- Exst Flow
- Existing Curb
- Existing Valley Gutter
- Existing Driveway Gutter
- Existing Curb and Gutter
- Existing Mountable Curb and Gutter

- Existing 3-Cable w Posts
- Site Boundary
- Existing Berm, Dike, Pit, or Earth Dam
- Existing Ditch Block
- Existing Tree Boundary
- Existing Brush or Shrub Boundary
- Existing Retaining Wall
- Existing Planter or Wall
- Existing W-Beam Guardrail with Posts
- Existing Railroad Switch
- Gravel Pit - Borrow Area
- Existing Wet Area-Vegetation Break
- Existing High Tension Cable Guardrail
- Existing High Tension Cable Guardrail with Posts

## Proposed Topography

- 3-Cable w Posts
- Flow
- Fence
- Remove Line
- Wall
- Retaining Wall (Plan View)
- W-Beam w Posts
- High Tension Cable Guardrail with Posts

## Existing Utilities

- Existing Electrical
- Existing Fiber Optic Line
- Existing TV Fiber Optic
- Existing Gas Pipe
- Existing Overhead Utility Line
- Existing Power
- Existing Fuel Pipeline
- Existing Undefined Above Ground Pipe Line
- Existing Sanitary Sewer
- Existing Sanitary Force Main
- Existing Storm Drain
- Existing Storm Drain Force Main
- Existing Culvert
- Existing Telephone Line
- Existing TV Line
- Existing Water or Steam Line
- Existing Under Drain
- Existing Slotted Drain
- Existing Conduit
- Existing Conductor
- Existing Down Guy Wire Down Guy
- Existing Underground Vault or Lift Station

## Proposed Utilities

- 24 Inch Pipe
- Reinforced Concrete Pipe
- Under Drain
- Edge Drain

## Traffic Utilities

- Conductor
- Fiber Optic
- Existing Loop Detector
- Existing Double Micro Loop Detector
- Micro Loop Detector Double
- Existing Micro Loop Detector
- Micro Loop Detector
- Signal Head with Mast Arm
- Existing Signal Head with Mast Arm

## Sign Structures

- Existing Overhead Sign Structure
- Existing Overhead Sign Structure Cantilever
- Overhead Sign Structure Cantilever

NORTH DAKOTA DEPARTMENT OF TRANSPORTATION	
07-01-14 REVISIONS	
DATE	CHANGE
09-23-16	Added and Revised Items, Organized by Functional Groups General Revisions
12-18-20	

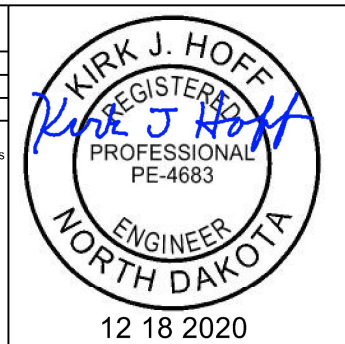

# LINE STYLES

D-101-21

### Right Of Way

- Easement
- Existing Easement
- Right of Way
- Existing Right of Way
- Existing Right of Way Railroad
- Existing Right of Way Not State Owned
- Existing Government Lot Line
- ..... Existing Adjacent Block Lines
- ..... Existing Adjacent Lot Lines
- ..... Existing Adjacent Property Line
- ..... Existing Adjacent Subdivision Lines
- ..... Sight Distance Triangle Line
- Dimension Leader

### Boundary Control

- ////// Existing City Corporate Limits or Reservation Boundary
- Existing State or International Line
- Existing Township
- Existing County
- Existing Section Line
- Existing Quarter Section Line
- Existing Sixteenth Section Line
- Existing Centerline
- Tangent Line

### Cross Sections and Typical

- Existing Ground
- Existing Topsoil (Cross Section View)
- void - void - void - v Existing Ground Void (Not Surveyed)
- Existing Concrete
- Existing Aggregate (Cross Section View)
- Existing Curb and Gutter (Cross Section View)
- Existing Asphalt (Cross Section View)
- Existing Reinforcement Rebar

### Geotechnical

- D ----- D ----- Geotextile Fabric Type D
- **Geo** ----- **Geo** ----- Geogrid
- R ----- R ----- Geotextile Fabric Type R
- R ----- R ----- Geotextile Fabric Type R1
- RR ----- RR ----- Geotextile Fabric Type RR
- S ----- S ----- Geotextile Fabric Type S

### Countours

- Depression Contours
- Supplemental Contour

### Profile

- Subgrade, Subcut or Ditch Grade
- Topsoil Profile

### Striping

- Centerline Pavement Marking
- ===== Barrier with Centerline Pavement Marking
- ===== Barrier Pavement Marking
- - - - - Stripe 4 IN Dotted Extension White
- - - - - Stripe 8 IN Dotted Extension White
- - - - - Stripe 8 IN Lane Drop

### Pavement Joints

- ===== Doweled Joint
- +++++ Tie Bar 30 Inch 4 Foot Center to Center
- +++++ Tie Bar 18 Inch 3 Foot Center to Center
- +++++ Tie Bar at Random Spacing

### Bridge Details

- Small Hidden Object
- Large Hidden Object
- Phantom Object
- Existing Conditions Object
- Centerline Main
- Centerline Secondary
- Excavation Limits
- Proposed Ground
- Sheet Piling

### Erosion Control

- Limits of Const Transition Line
- Bale Check
- Rock Check
- s ----- s ----- Floating Silt Curtain
- SF ----- SF ----- Silt Fence
- Excavation Limits
- Fiber Rolls

### Environmental

- Wetland Mitigation
- Existing Wetland Easement USFWS
- Existing Wetland Jurisdictional
- Existing Wetland
- Tree Row

NORTH DAKOTA DEPARTMENT OF TRANSPORTATION	
07-01-14	
REVISIONS	
DATE	CHANGE
09-23-16	Added and Revised Items, Organized by Functional Groups General Revisions
12-18-20	



SYMBOLS



North Arrow (Half Scale)



Alignment Data Point



Alignment Monument



Spot Elevation



Existing Miscellaneous Spot



Existing Access Control Arrow



Existing Benchmark



Reset USGS Marker



Iron Monument Found



Iron Pin R/W Monument



Property Corner



Iron Pin Reference Monument



Right of Way Marker (Exst, Ppsd, Reset)



Existing Federal Reference Corner



Existing Section Corner (Full, Quarter, Sixteenth, Meander)



Existing Witness Corner



Existing Control Point (CP, GPS-RTK, TRI)



Existing Traverse PI Aerial Panel



Existing Reference Marker Point NGS



Existing EFB Misc



Existing Bush or Shrub



Existing Large Evergreen Tree



Existing Small Evergreen Tree



Existing Large Tree



Existing Small Tree



Existing Tree Trunk

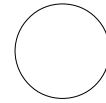

Cairn or Stone Circle



Existing Artifact



Existing Satellite Dish



Existing Weather Station



Existing Windmill or Tower



Reinforced Pavement



Continuous Split Barrel Sample



Flight Auger Sample



Split Barrel Sample



Thinwall Tube Sample



Standard Penetration Test



Inclinometer Tube



Excavation Unit



Existing Ground Water Well Bore Hole

NORTH DAKOTA  
DEPARTMENT OF TRANSPORTATION

07-01-14

REVISIONS

DATE	CHANGE
12-18-20	General Revisions



















































































12 18 2020



# SYMBOLS

D-101-32

 Existing Luminaire  Luminaire LED  Existing Light Standard Luminaire  Relocate Light Standard  Light Standard Light LED Luminaire  Light Standard 35 Watt High Pressure Sodium Vapor Luminaire  Light Standard 50 Watt High Pressure Sodium Vapor Luminaire  Light Standard 70 Watt High Pressure Sodium Vapor Luminaire  Light Standard 100 Watt High Pressure Sodium Vapor Luminaire  Light Standard 150 Watt High Pressure Sodium Vapor Luminaire  Light Standard 200 Watt High Pressure Sodium Vapor Luminaire  Light Standard 250 Watt High Pressure Sodium Vapor Luminaire  Light Standard 310 Watt High Pressure Sodium Vapor Luminaire  Light Standard 400 Watt High Pressure Sodium Vapor Luminaire  Light Standard 700 Watt High Pressure Sodium Vapor Luminaire  Light Standard 1000 Watt High Pressure Sodium Vapor Luminaire  Emergency Vehicle Detector  Video Detection Camera	  High Mast Light Standard 3 Luminaire (Exst, Ppsd)   High Mast Light Standard 4 Luminaire (Exst, Ppsd)   High Mast Light Standard 5 Luminaire (Exst, Ppsd)   High Mast Light Standard 6 Luminaire (Exst, Ppsd)   High Mast Light Standard 7 Luminaire (Exst, Ppsd)   High Mast Light Standard 8 Luminaire (Exst, Ppsd)   High Mast Light Standard 9 Luminaire (Exst, Ppsd)   High Mast Light Standard 10 Luminaire (Exst, Ppsd)   Overhead Sign Structure Load Center (Exst, Ppsd)   Traffic Signal Controller (Exst, Ppsd)   Pad Mounted Traffic Signal Controller (Exst, Ppsd)   Flashing Beacon (Exst, Ppsd)   Concrete Foundation (Exst, Ppsd)   Pipe Mounted Flasher (Exst, Ppsd)   Pad Mounted Feed Point (Exst, Ppsd)   Pipe Mounted Feed Point with Pad (Exst, Ppsd)   Pole Mounted Feed Point (Exst, Ppsd)   Junction Box (Exst, Ppsd)  Existing Pedestrian Head with Number  Existing Signal Head  Pole Mounted Head  Existing Lighting Standard Pole	 Existing Traffic Signal Standard    Pull Box (Exst-Ppsd-Undefined)   Intelligent Transportation Pull Box (Exst, Ppsd)   Transformer (Exst, Ppsd)    Power Pole (Exst-Ppsd-with Transformer)   Wood Pole (Exst, Ppsd)   Pedestrian Push Button Post (Exst, Ppsd)  Existing Pole  Existing Telephone Pole  Existing Post     Connection Conductor (Ground, Neutral, Phase 1, Phase 2)
---	---	--

NORTH DAKOTA DEPARTMENT OF TRANSPORTATION	
07-01-14	
REVISIONS	
DATE	CHANGE
12-18-20	General Revisions



KIRK J. HOFF

REGISTERED

PROFESSIONAL

PE-4683

ENGINEER

NORTH DAKOTA

12 18 2020



EROSION AND SILTATION CONTROLS - SILT FENCE UNSUPPORTED

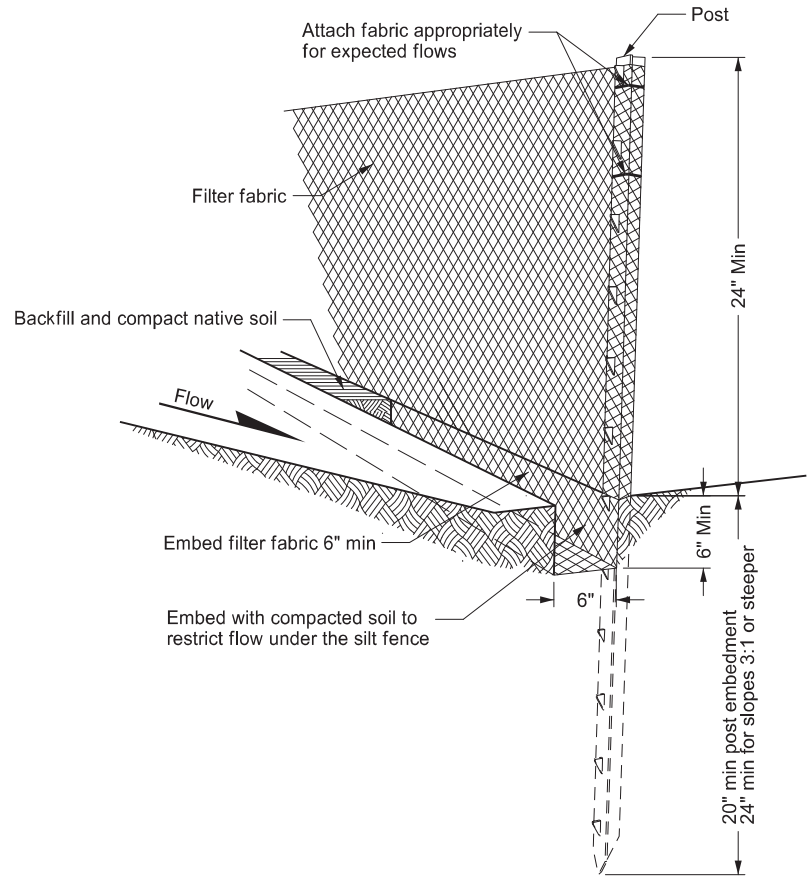

HAND PLACED INSTALLATION DETAIL

Minimize disturbance of ground around trench and smooth surface after excavation to avoid concentrating flows. Compact to prevent undercutting flows.

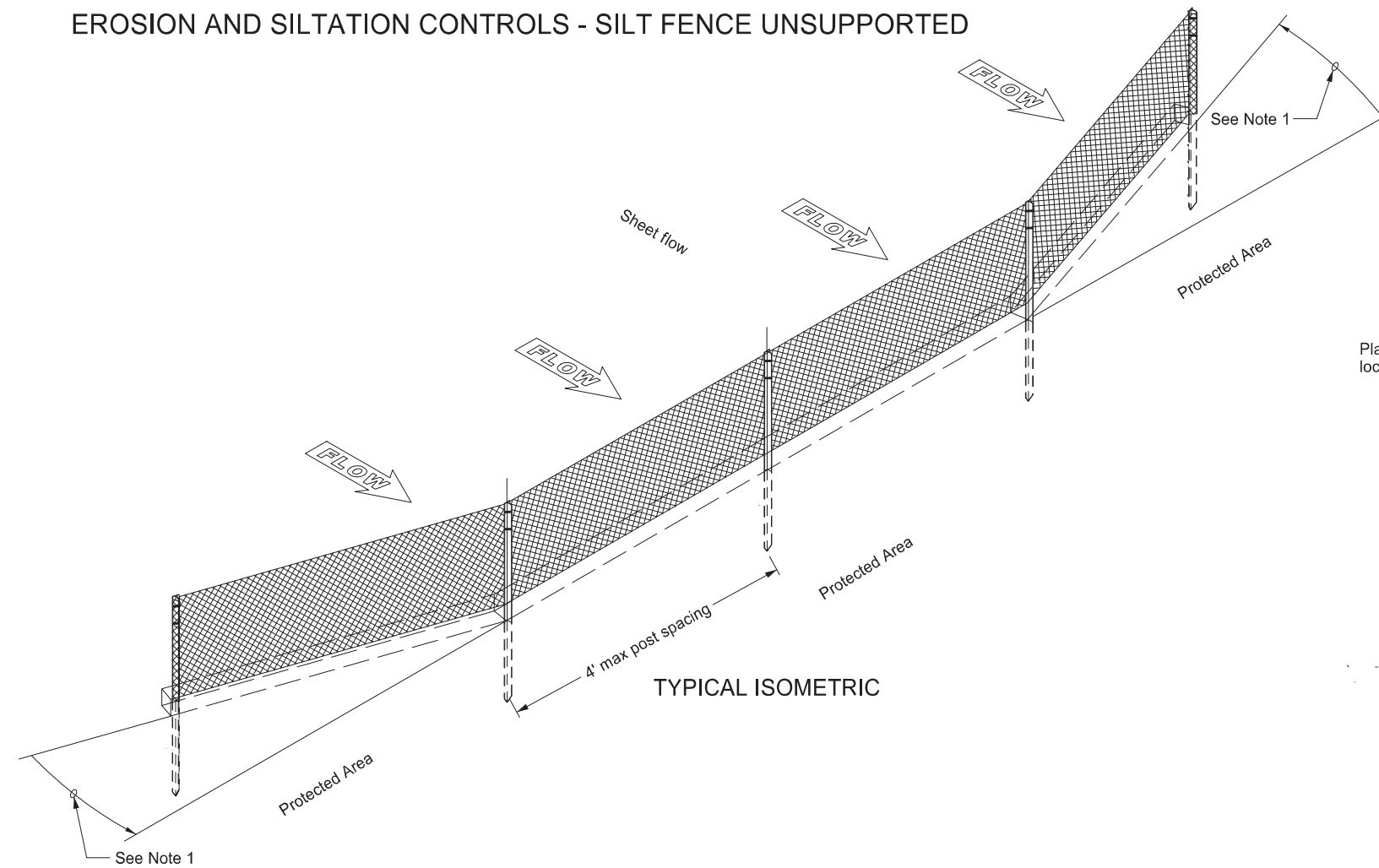

TYPICAL ISOMETRIC

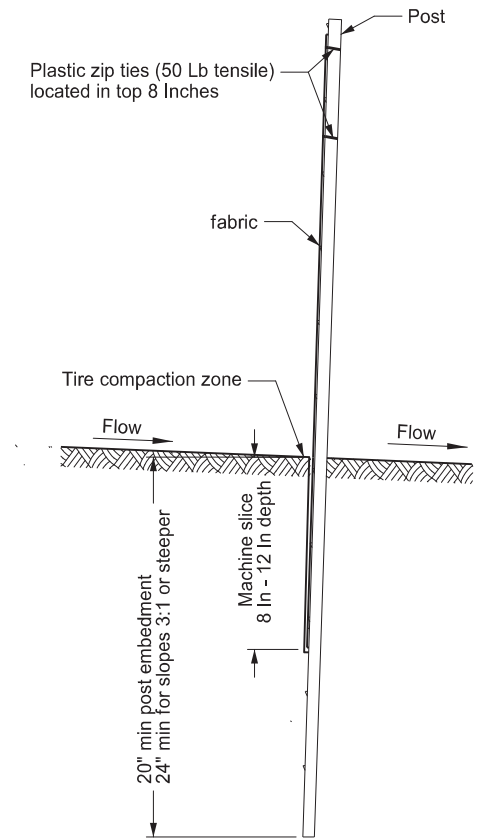

MACHINE SLICED INSTALLATION DETAIL

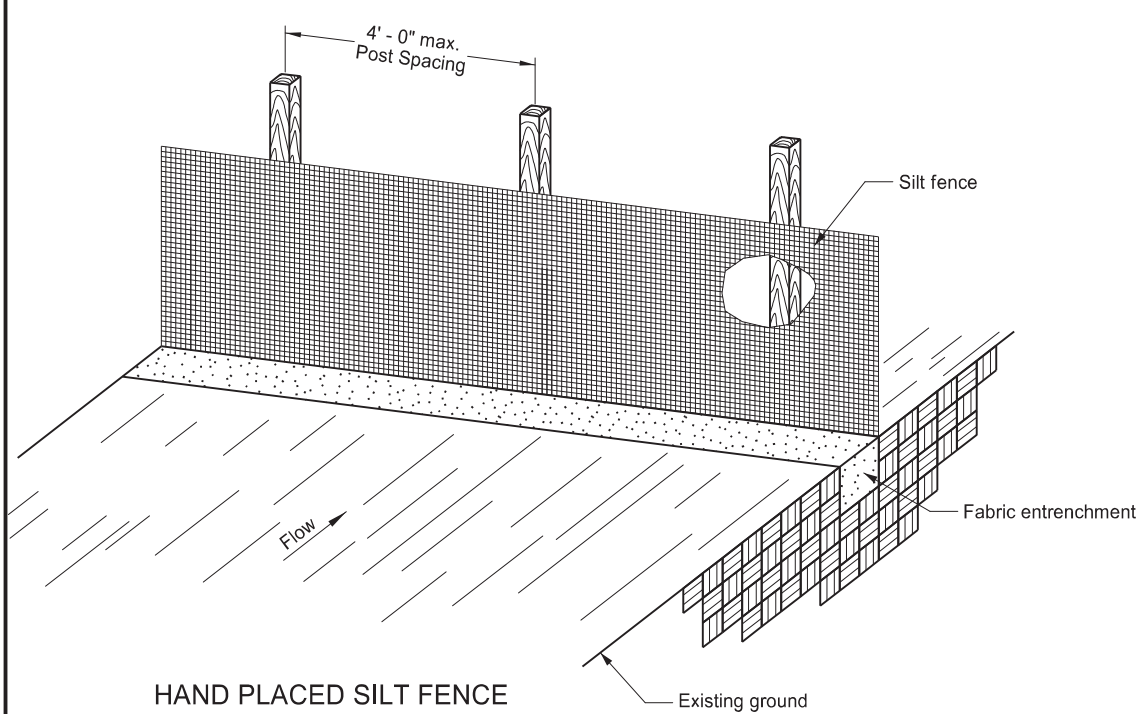

HAND PLACED SILT FENCE

- NOTES:
1. Install the ends of the silt fence to point slightly upslope to prevent sediment from flowing around the ends of the fence.
  2. Place splices outside low spots.
  3. Do not embed silt fence placed in standing water.

NORTH DAKOTA DEPARTMENT OF TRANSPORTATION	
10-03-13	
REVISIONS	
DATE	CHANGE
06-26-14	Standard drawing resulted from splitting standard D-708-2.
06-27-16	Revised details & added new ones.
08-27-19	New Design Engineer PE Stamp.
07-22-25	Matched Revised Silt Fence Specs.



07/22/25

LANE CLOSURES ON URBAN STREETS LAYOUTS

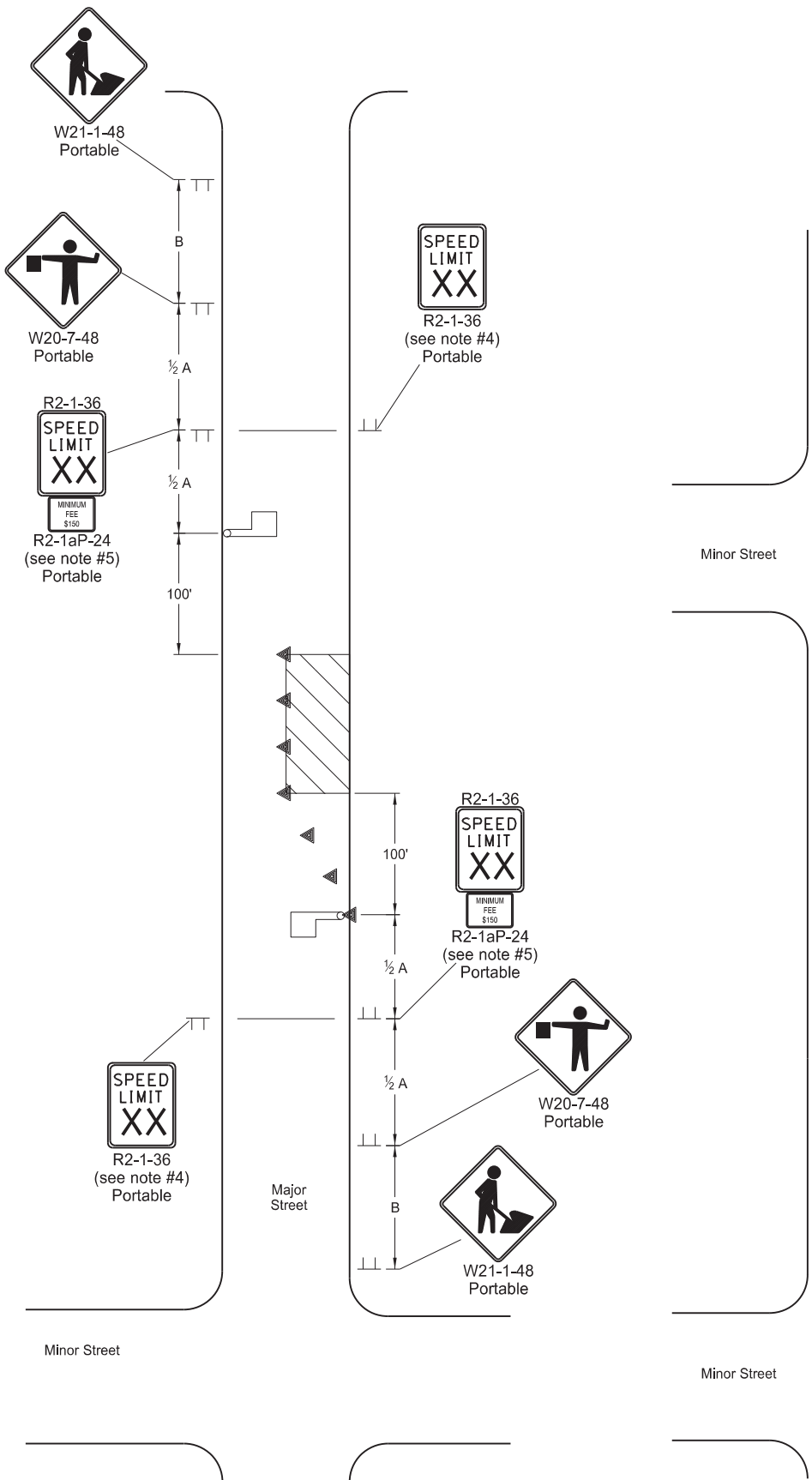

**TYPE V**  
LANE CLOSURE ON URBAN STREET

Portion of roadway closed to traffic only during daylight hours (mid block location).

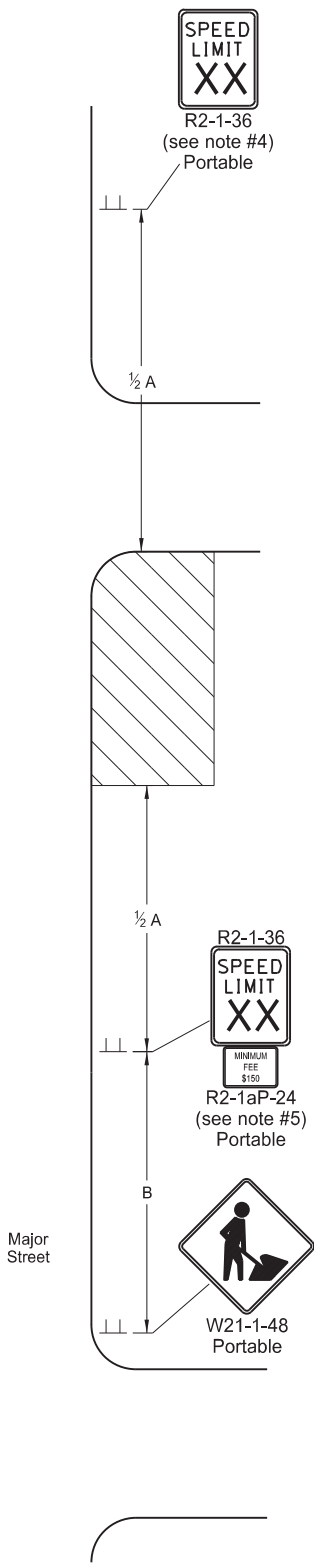

**TYPE W**  
WORK BEYOND CURB ON URBAN STREET

Work area outside driving lane and no closure necessary.

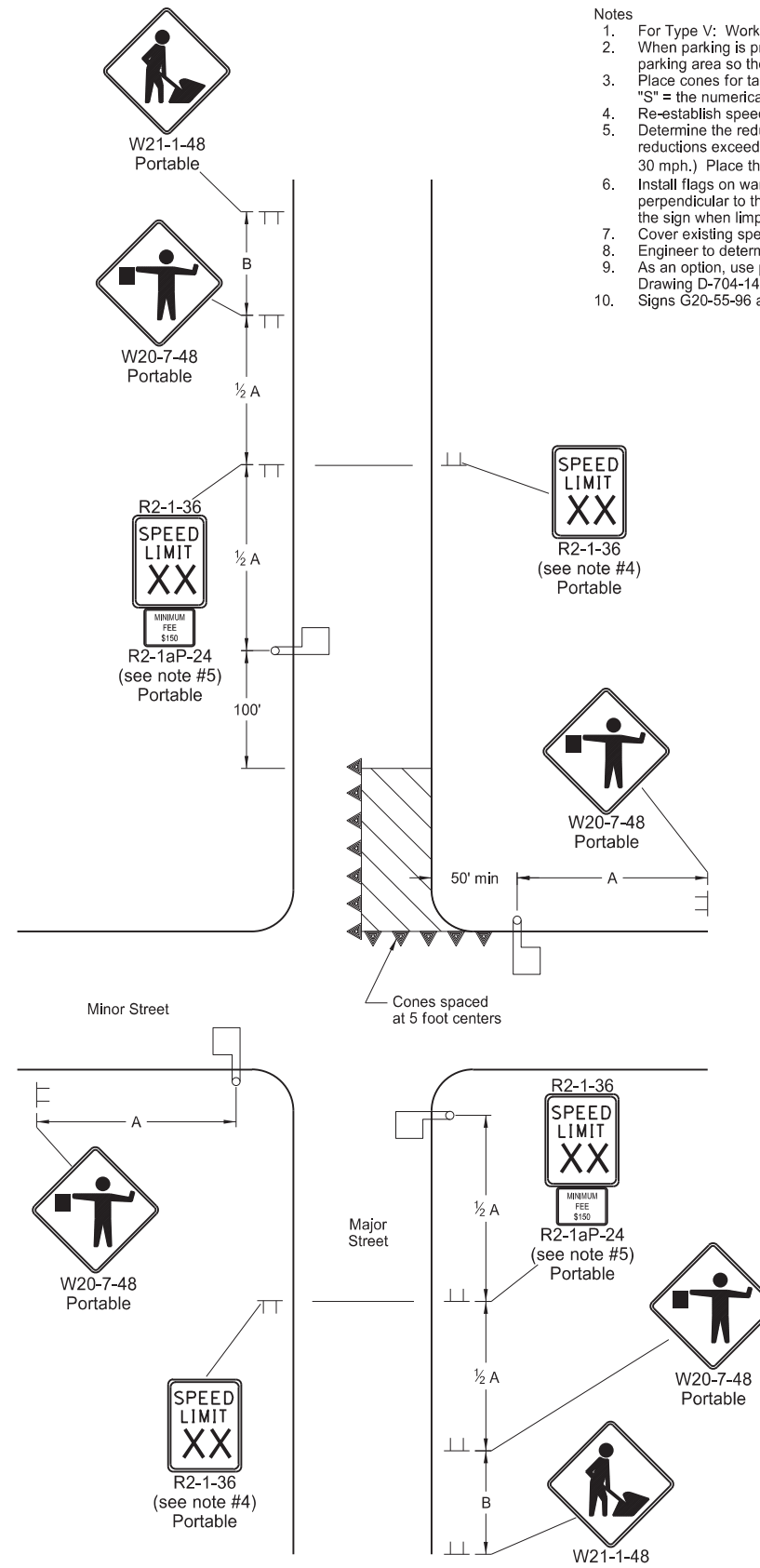

**TYPE X**  
LANE CLOSURE NEAR INTERSECTION ON URBAN STREET

Portion of roadway closed to traffic only during daylight hours (end block location).

- Notes
- For Type V: Work on one side of roadway at a time so as not to block off more than one lane of traffic.
  - When parking is present, place signs so they are entirely visible above parked vehicles or at the edge of the parking area so they are visible to oncoming traffic. Place signs on portable mounts when located on roadway.
  - Place cones for tapering traffic at 3 equal spaces and cones for tangents at dimension "S". "S" = the numerical value of speed limit.
  - Re-establish speed limit. Determine exact speed limit in the field, dependent on location and conditions.
  - Determine the reduced speed limit based on the in-place speed limit before construction. Where speed reductions exceed 30 mph, install a second speed limit sign with the desired speed reduction (not to exceed 30 mph.) Place the second speed limit sign at 1/2 B.
  - Install flags on warning signs in urban areas when signs are not portable. Mount 24 inches square flags perpendicular to the edges of the sign, and at such a distance above the edge that the flag does not touch the sign when limp.
  - Cover existing speed limit signs within reduced speed zones.
  - Engineer to determine safe speed, when necessary.
  - As an option, use portable sign supports in lieu of post mounted signs in accordance with NDDOT Standard Drawing D-704-14.
  - Signs G20-55-96 and R2-1aP-24 are not required for urban projects.

Road Type	ADVANCE WARNING SIGN SPACING		
	Distance Between Signs Min. (ft)		
	A	B	C
Urban - Low Speed (30 mph or less)	150	150	150
Urban - Low Speed (over 30 to 40 mph)	280	280	280
Urban - High Speed (over 40 mph to 50 mph)	360	360	360
Rural - High Speed (over 50 mph to 65 mph)	720	720	720
Urban Expressway and Freeway (55 mph to 60 mph)	850	1350	2200
Rural Expressway and Freeway (70 mph to 80 mph)	1000	1500	2640
Interstate/4-Lane Divided (Maintenance and Surveying)	750	1000	1500

KEY

	Sign		Work area
	Cones		Flagger

NORTH DAKOTA DEPARTMENT OF TRANSPORTATION	
9-27-13	
REVISIONS	
DATE	CHANGE
08-17-17	Updated notes & removed signs
11-01-19	Revised note & added Min Fee sign
08-01-24	Electronic Stamp/Signature
06-30-25	Legislative Changes



Curb & Gutter and Valley Gutter

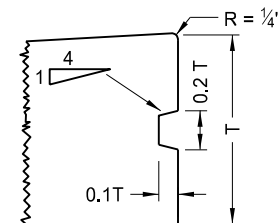
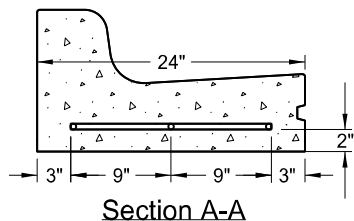
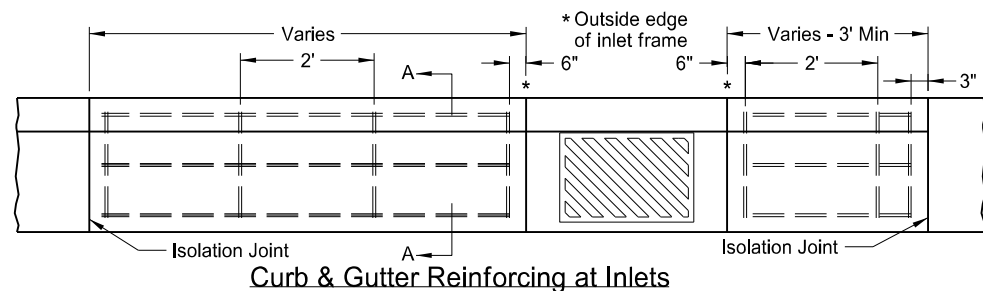

Keyway Detail for Curb & Gutter  
(To be used with PCC Pavement and Drives)

T = Thickness of pavement unless otherwise noted on plans.

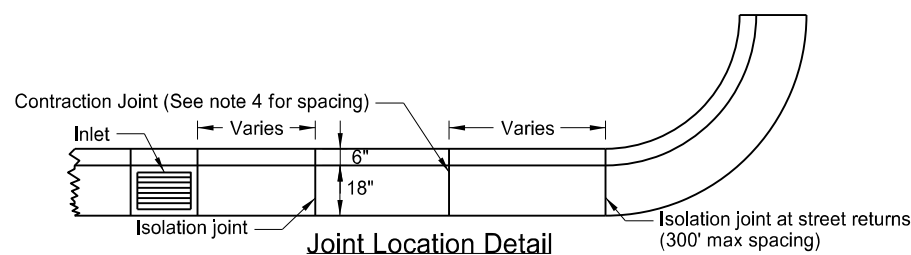

Joint Location Detail

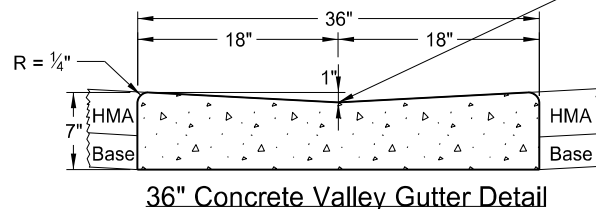

36" Concrete Valley Gutter Detail

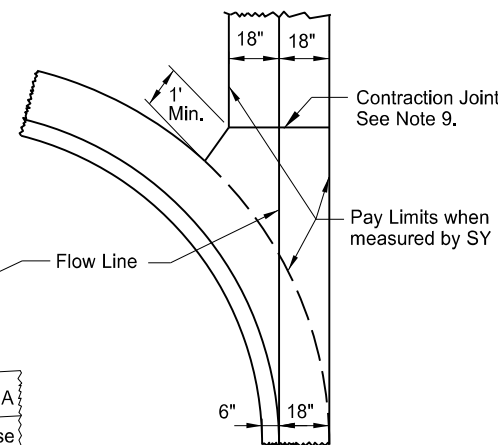

36" Concrete Valley Gutter Plan

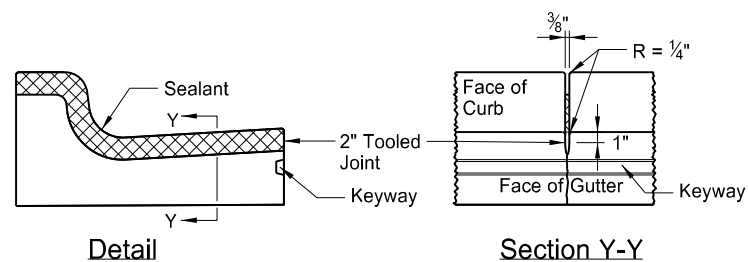

Detail  
(10' Max Spacing) Contraction Joint

Section Y-Y

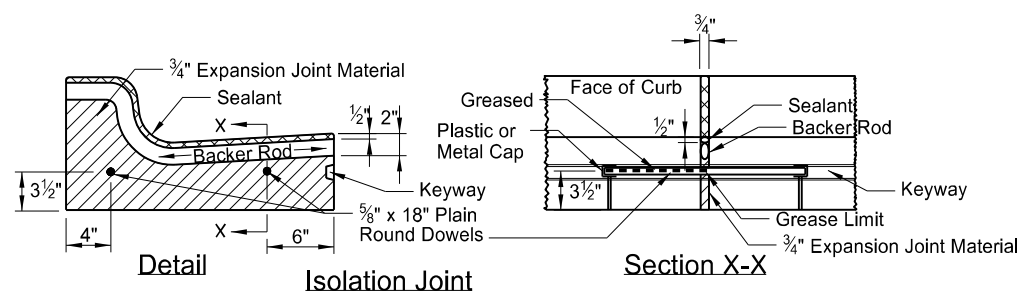

Detail  
Isolation Joint

Section X-X

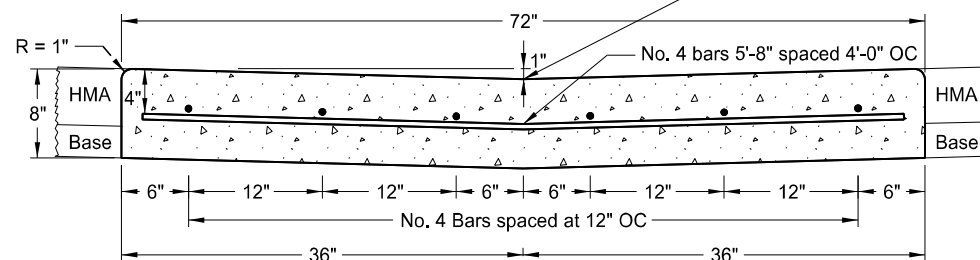

72" Concrete Valley Gutter Detail

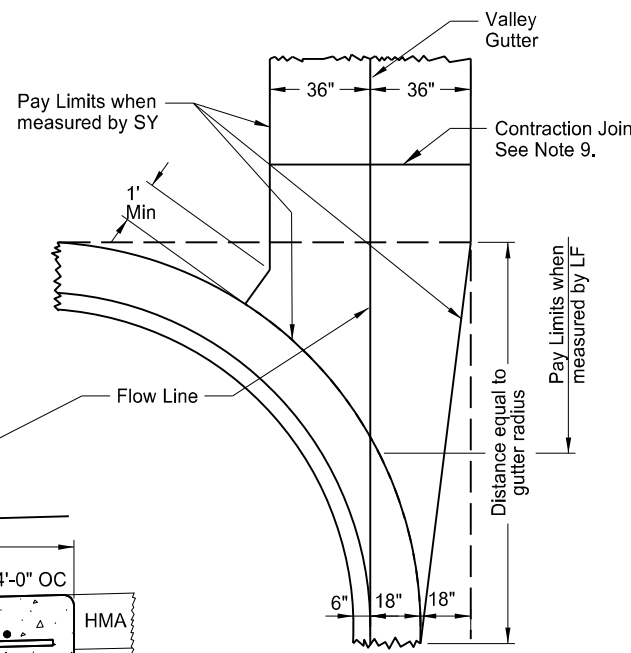

72" Concrete Valley Gutter Plan

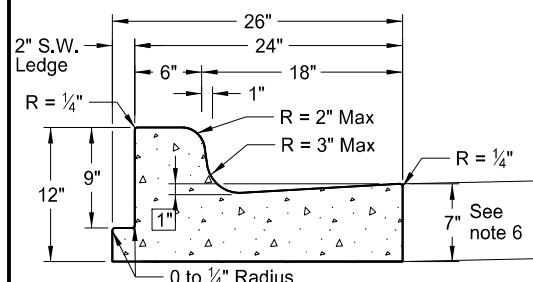

Curb & Gutter Type 1 (Sec. A & B)  
Adjacent to Concrete Sidewalk, Median,  
or Parking Lot. (Sec. A shown. See  
Sec B for additional details.)

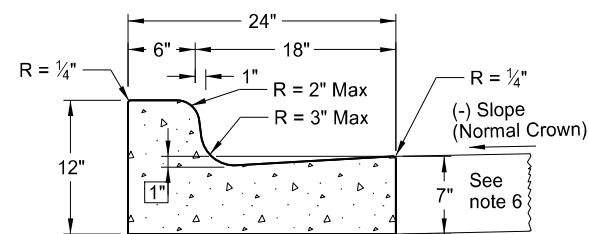

Curb & Gutter Type 1 (Sec. A)

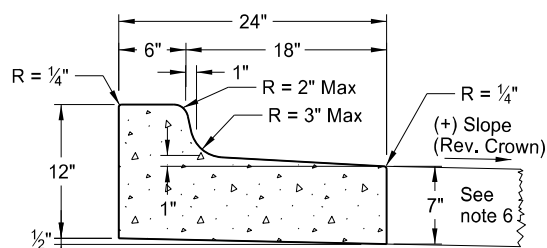

Curb & Gutter Type 1 (Sec. B)

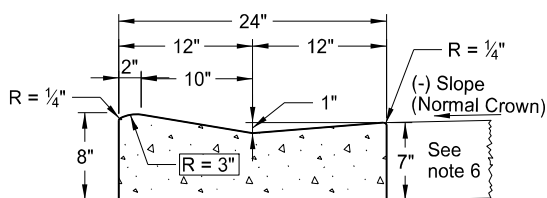

Mountable Curb & Gutter Type 1 (Sec. A)

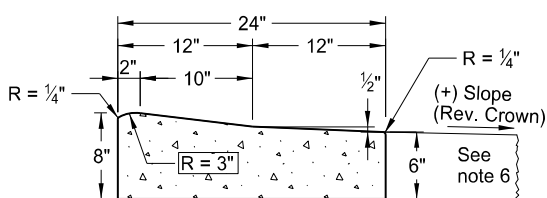

Mountable Curb & Gutter Type 1 (Sec. B)

NOTES:

1. Use Curb and Gutter Type 1 (Sec. A & B). Use section "A" with (-) pavement slopes and section "B" with (+) pavement slopes.
2. Contraction Joints: Tool the Curb & Gutter 2" as shown on the contraction joint details.
3. Isolation Joints: Use 3/4" expansion joint material for isolation joints. Form the backer rod and joint sealant opening with a pre-cut piece of wood or other material approved by the engineer. Dowel supports are not required on the second pour at a cold joint. Install plastic or metal caps and greased dowels in the cold joint for the second pour.
4. Joint Spacing: For hot mix asphalt pavements use a 10' max joint spacing for the curb and gutter with panels on each side of the inlets. For concrete pavements match the joint spacing for the curb and gutter to the pavement joint on PCC Pavements (approximately 15' spacing.)
5. Joint sealing: For contraction joint, use joint sealant that conforms to section 826.02B. Use sealant for expansion joints specified in note 3 above. Tool and install sealant in accordance with the manufacturer's recommendations.
6. Curb & Gutter-Pavement Interface: For hot mix asphalt pavement use gutter depth shown. For PCC pavements, either match gutter depth to adjacent pavement depth or construct gutter depth shown.
7. Tie curb and gutter to abutting PCC pavement with No. 4 bars, 2'-0" in length, spaced at 3'-9" centers for 15' joint spacing (maximum spacing of 4' centers).
8. On street returns and other locations where new curb and gutter ends and does not abut existing curb and gutter, taper the last two (2) feet of the curb from 6" in height to 0". Install a 1/2" premolded full depth isolation joint (the same shape as the curb and gutter just ahead of the taper) with an 18" plain round bar across the joint.
9. Valley Gutter Joints: Form, saw, or score 1/8" min. to 3/8" max. width contraction joints (a minimum 2" depth) at approx 10' intervals. Seal the joints with hot poured elastic type joint sealer (Section 826.02A.2 of the Standard Specifications.) Include all costs for the joint and sealant in the price bid for Valley Gutter.
10. Reinforcing at Inlets: Use #4 deformed reinforcing bars without splices. Include all costs for reinforcing bars at inlets (even inlets located on radii) in the price bid for "Curb & Gutter - Type 1" or "Curb & Gutter Mountable - Type 1." Extend reinforcement to the second joint (with rebar placed through the first joint) in cases where the 3' minimum panel length can't be obtained.

NORTH DAKOTA DEPARTMENT OF TRANSPORTATION	
8-7-2013	
REVISIONS	
DATE	CHANGE
10-17-17	Updated to active voice.
08-27-19	New Design Engr PE Stamp.
10-30-24	Revised bar size & notes.



10/30/24

SIDEWALK

NOTES:

1. Curb ramp and detectable warning panel layouts for informational purposes only. See Standard Drawing D-750-3 for curb ramp and detectable warning panel details.
2. Joint Spacing: Vary transverse contraction joint spacing from 4' to 6' to create approximate square panels.  
Use longitudinal contraction joints when sidewalk width is 8' or greater, and space at half the sidewalk width.  
Saw or groove contraction joints to a minimum depth of 1/3 the depth of the concrete.  
When sidewalk is adjacent to curb & gutter, vary the sidewalk joint spacing to match curb & gutter joints.  
Use isolation joints between separate concrete pours, or between old and new concrete.
3. Include all costs for labor, equipment, and material necessary to construct contraction and isolation joints in the price bid for sidewalk concrete.
4. Use 4" sidewalk concrete thickness unless otherwise specified.
5. Use 4" base material thickness unless otherwise specified. Include all costs for labor and materials necessary to place the base material in the price bid for "Salvage Base Course" or "Aggregate Base Course CL 5."  
Modify existing ground slope with landscaping as needed. If not possible, such as adjacent buildings, use a vertical curb as shown in the detail below. The Engineer will measure curb at the unit price bid for "Curb - Type I" per lineal foot.
6. Sidewalk Width & Grade: Provide a continuous 4' min clear width pedestrian access route with max 2% concrete cross slope, excluding flares. The width of the curb cannot be counted as part of the pedestrian access route.  
When clear width of pedestrian access routes is less than 5.0', provide passing spaces at a maximum of 200' with a minimum size of 5.0' by 5.0'.

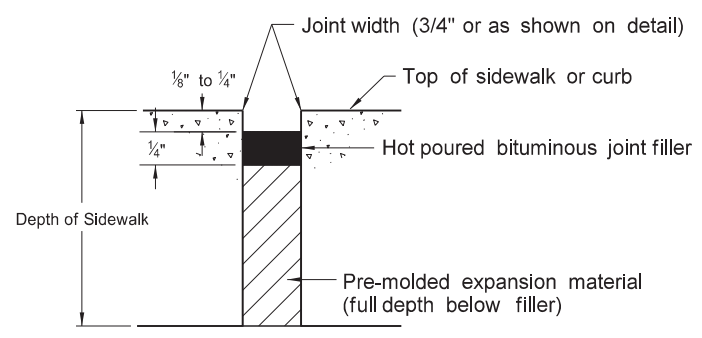
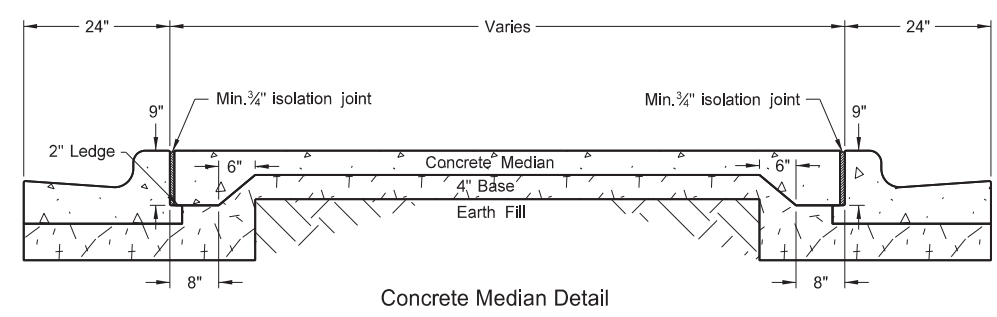
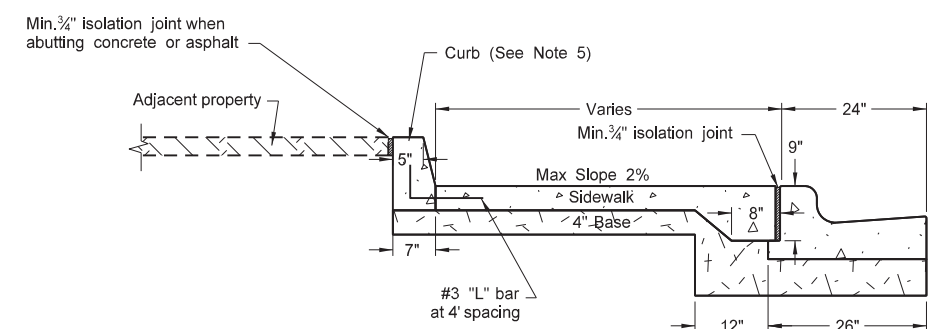
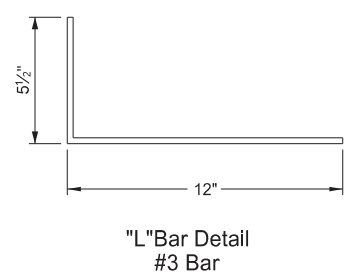
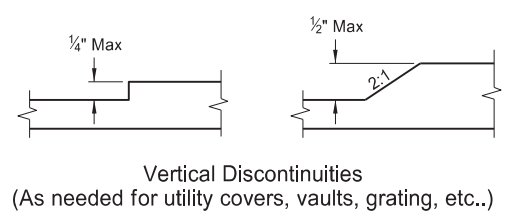
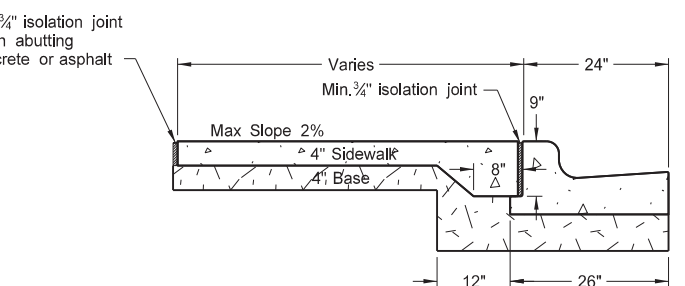
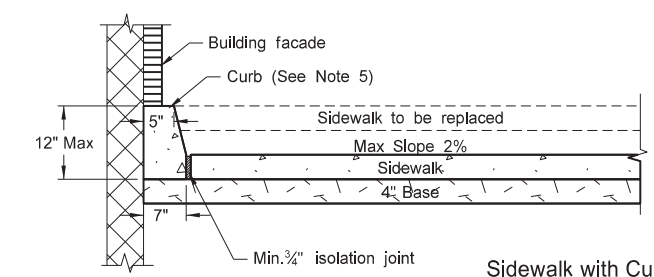
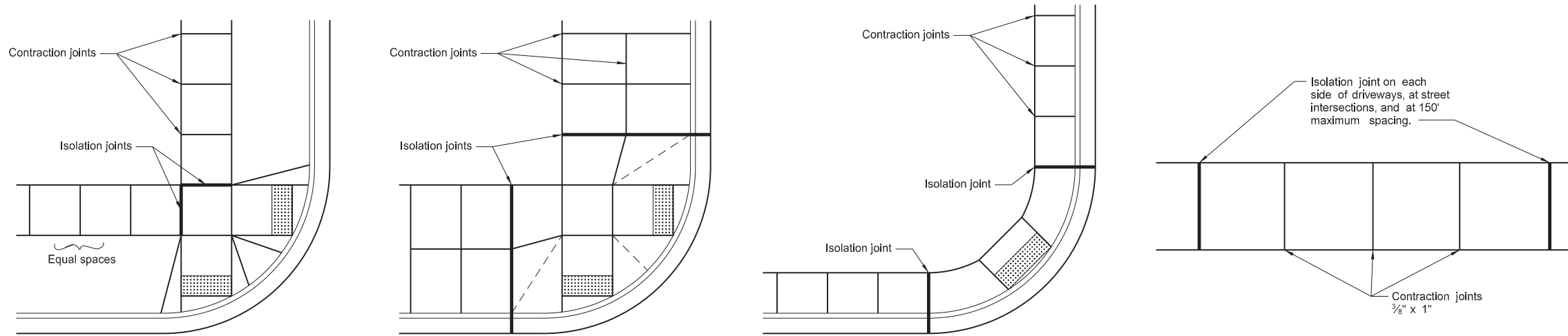

NORTH DAKOTA DEPARTMENT OF TRANSPORTATION	
11-26-13	
REVISIONS	
DATE	CHANGE
10-17-17	Updated to active voice.
09-05-18	Added sidewalk details for width & grade & passing lane requirements.
08-27-19	New Design Engineer PE Stamp.
08-09-24	Electronic Stamp/Signature.



08/09/24

# CURB RAMP RETROFIT DETAILS

D-750-3

NOTES:

- Ramp width is the useable portion of the ramp, excluding flares. Match curb ramp width to Existing Pedestrian Facility (EPF) width (4' minimum or 5' for island ramps.) Match ramp width to existing shared use path width. Maximum ramp length is 15'.
- Provide turning space with desirable 5' x 5' size or larger and minimum 4' x 4' unconstrained size, for any change of direction. Provide landing 5' long x width of path at the bottom and top of parallel ramps and at the top of perpendicular ramps. Turning spaces and Landings may overlap.
- Match detectable warning panel width to ramp width. Radial panels are allowed. Place detectable warning panel within the lower turning space.
- Provide a continuous 4' minimum width EPF with 1.5% preferred cross slope and max 2% constructed cross slope.
- Modify existing ground slope with landscaping, as needed. If not possible, use a vertical curb as detailed on Standard D-750-2. The Engineer will measure curb at the unit price bid for "Curb - Type I" per lineal foot.
- Islands: If the profile of the island curb ramp is 2% or less, provide a minimum distance of 2' between warning panels. If the profile of the island curb ramp is steeper than 2%, provide a turning space between the ramps.
- Provide generally planar vertical alignments. Provide grade breaks, perpendicular to the direction of the pedestrian travel, at the top and bottom of curb ramps (1.5% preferred, 2% max constructed cross slope).
- See Curb Ramp Retrofit Details Standard D-750-4 for additional information. Also See PROWAG for full compliance in the curb ramp area.
- Grade transitions shall be flush.

LEGEND:

- : Detectable Warning Panel.
- : Landscaping.
- : Transitional tie-in to nearest joint, if needed.
- : Curb Ramp Retrofit Transitional Area (See Standard Drawing D750-4)
- : 4' long x width of EPF or 4' minimum Clear space outside traffic lanes of travel. 1.5% preferred cross slope 2% maximum cross slope 4.7% preferred running and counter slope 5% maximum running and counter slope
- (TS)** : Turning Space Use at top of ramp or when changing directions. 1.5% preferred slope (2% maximum) all directions.
- (R)** : Preferred Ramp Grade = 5% to 7.5%. Maximum Constructed Grade = 8.3%. Preferred Cross Slope = 1.5%. Maximum Constructed Cross Slope = 2%.
- (B)** : 1.5% preferred cross slope 2% maximum constructed cross slope running slope consistent with the EPF 4.7% preferred max counter slope 5.0% max constructed counter slope
- (10)** : 10:1 maximum constructed slope.
- (4)** : 4:1 maximum constructed slope.
- 0", 3", or 6" : Curb Height.

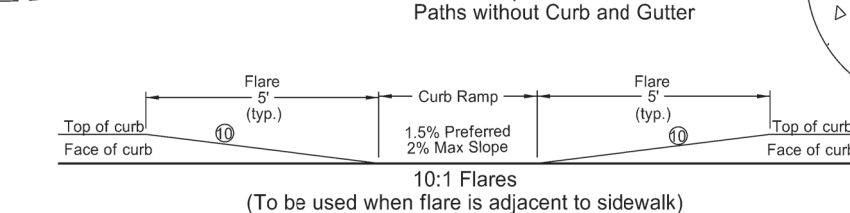
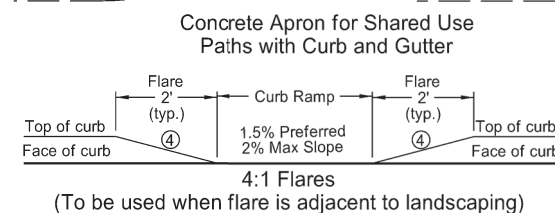
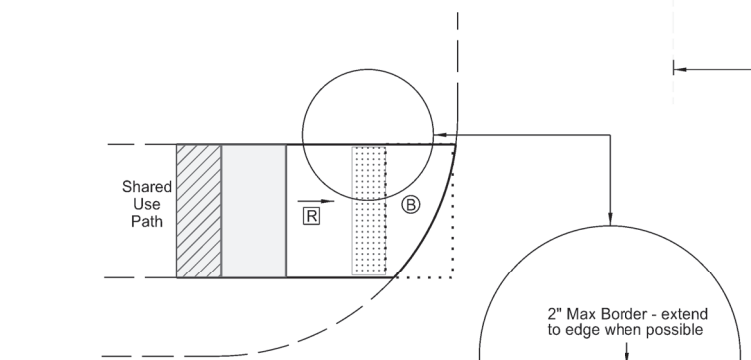
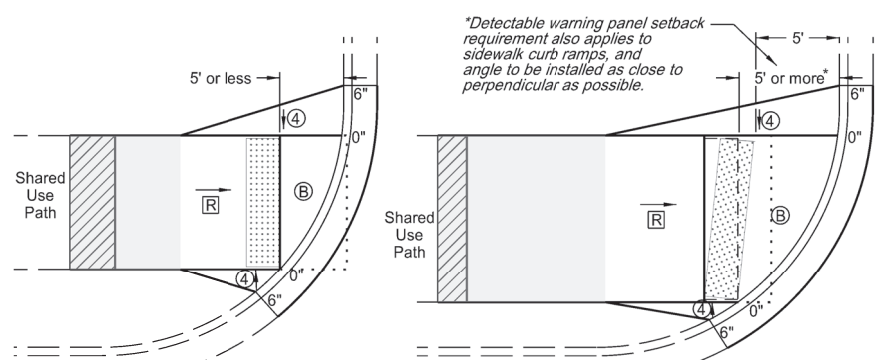
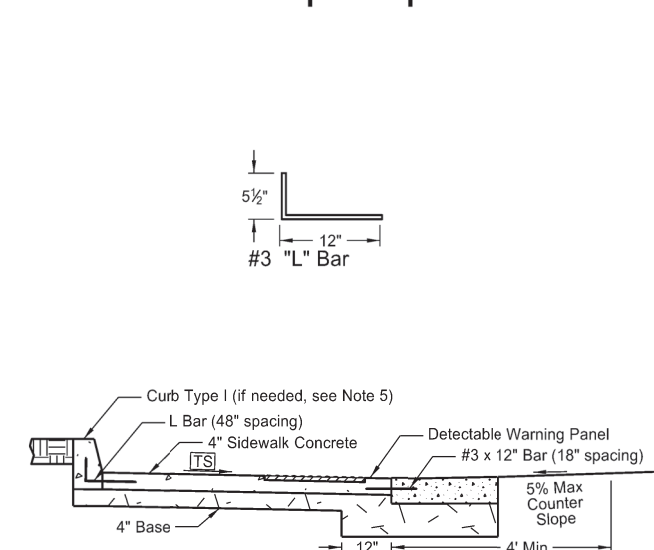
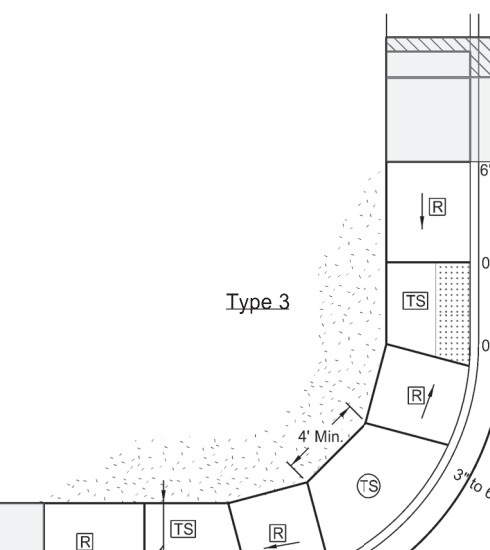
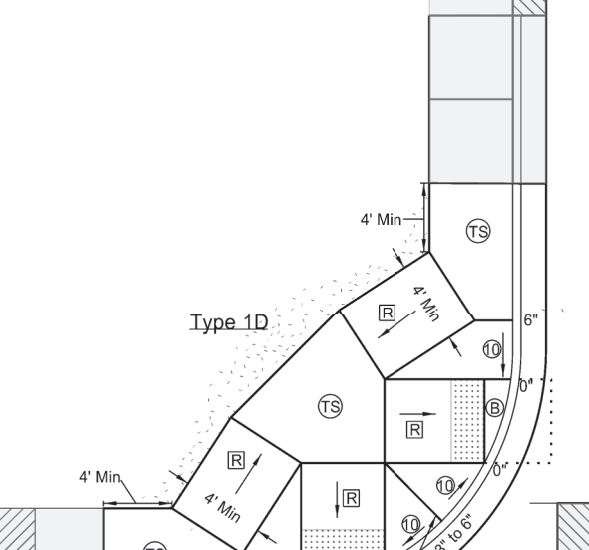
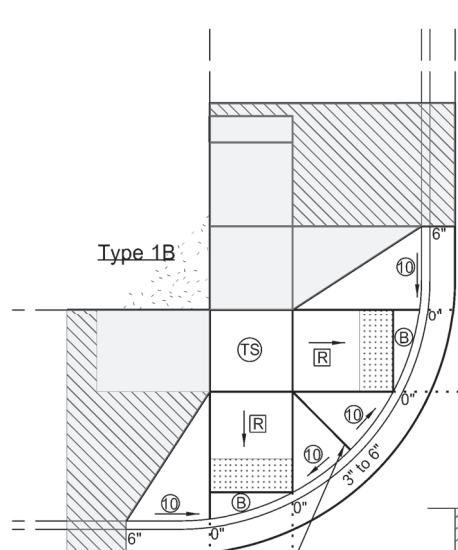
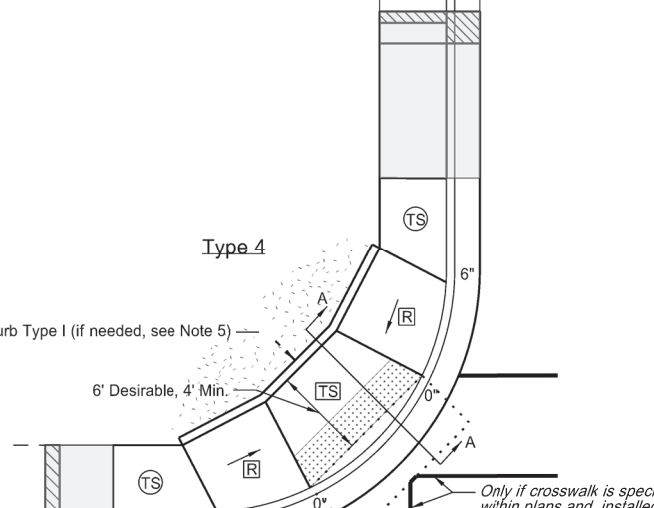
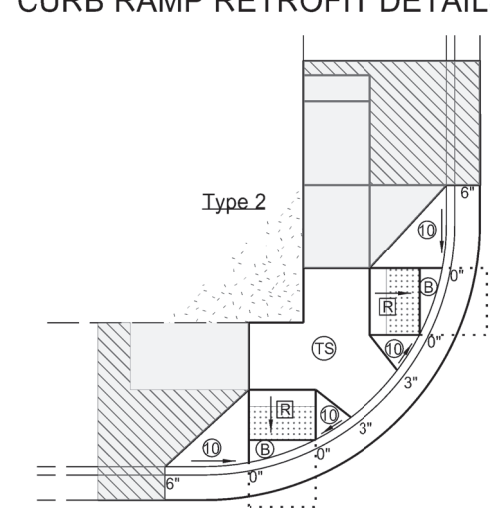
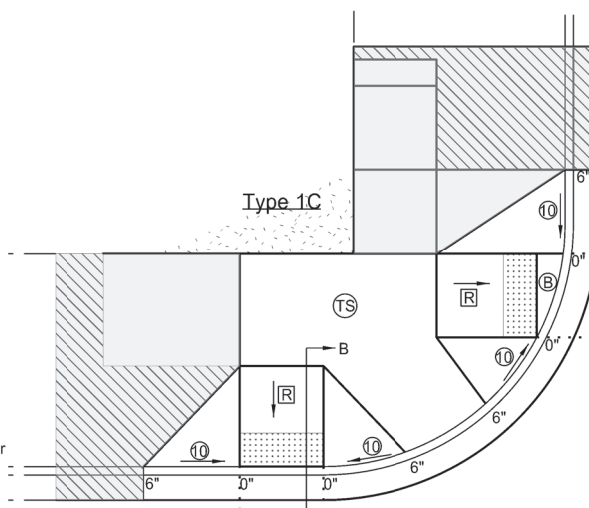
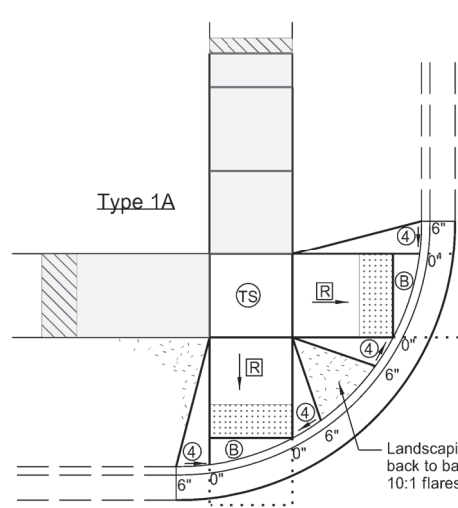

Median Refuge Islands (Cut-Through)

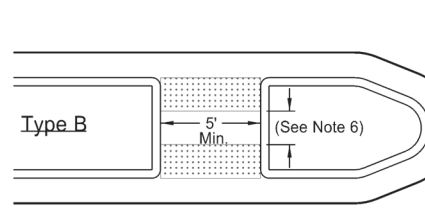
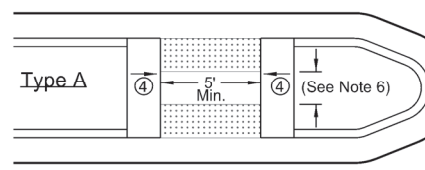

NORTH DAKOTA DEPARTMENT OF TRANSPORTATION	
11-26-13	
REVISIONS	
DATE	CHANGE
10-17-17	Updated to active voice.
09-05-18	Revised Notes, Revision for Turning Space, Added Passing Space Requirements, Turned Detectable Warning Panel
03-15-21	Slope & other clarifications.
05-19-21	Separate Curb Ramp Transition Area from Curb Ramp area

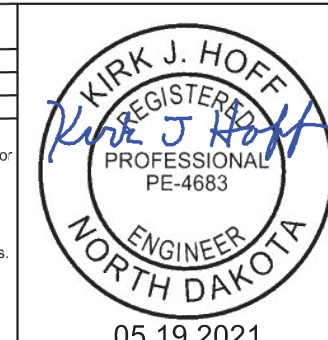

# CURB RAMP RETROFIT TRANSITIONAL AREA DETAILS

D-750-4

**NOTES:**

1. Curb Ramp Transitional Areas are to transition from the Curb Ramp area into the Existing Pedestrian Facility (EPF). Each layout shows example transitions. Use any combination for transitions from the Ramp Area into the EPF that allows for similar or gentler slopes to that of the existing condition, yet transitions in the shortest distance possible. In some cases, if grades allow, the Ramp area can immediately transition into the EPF and no transitional area is needed.
2. Option 1: Use this transition when existing running slope grades are less than 5%. Transition from the ramp area to the EPF using the Pedestrian Access Transition Area (PTA) transition rates and in less than 20 feet.
3. Option 2: Use this transition when existing running slopes are greater than 5% and option 1 is not able to be met.  
  
Add a ramp and a landing immediately after the ramp area. Then transition from the compliant landing into the EPF using the PTA rates (preferred), or in less than 15 feet (which ever is shorter).
4. Transitional Areas for Shared Use Paths can be concrete or asphalt.
5. See Curb Ramp Retrofit Details Standard D-750-3 for additional information.

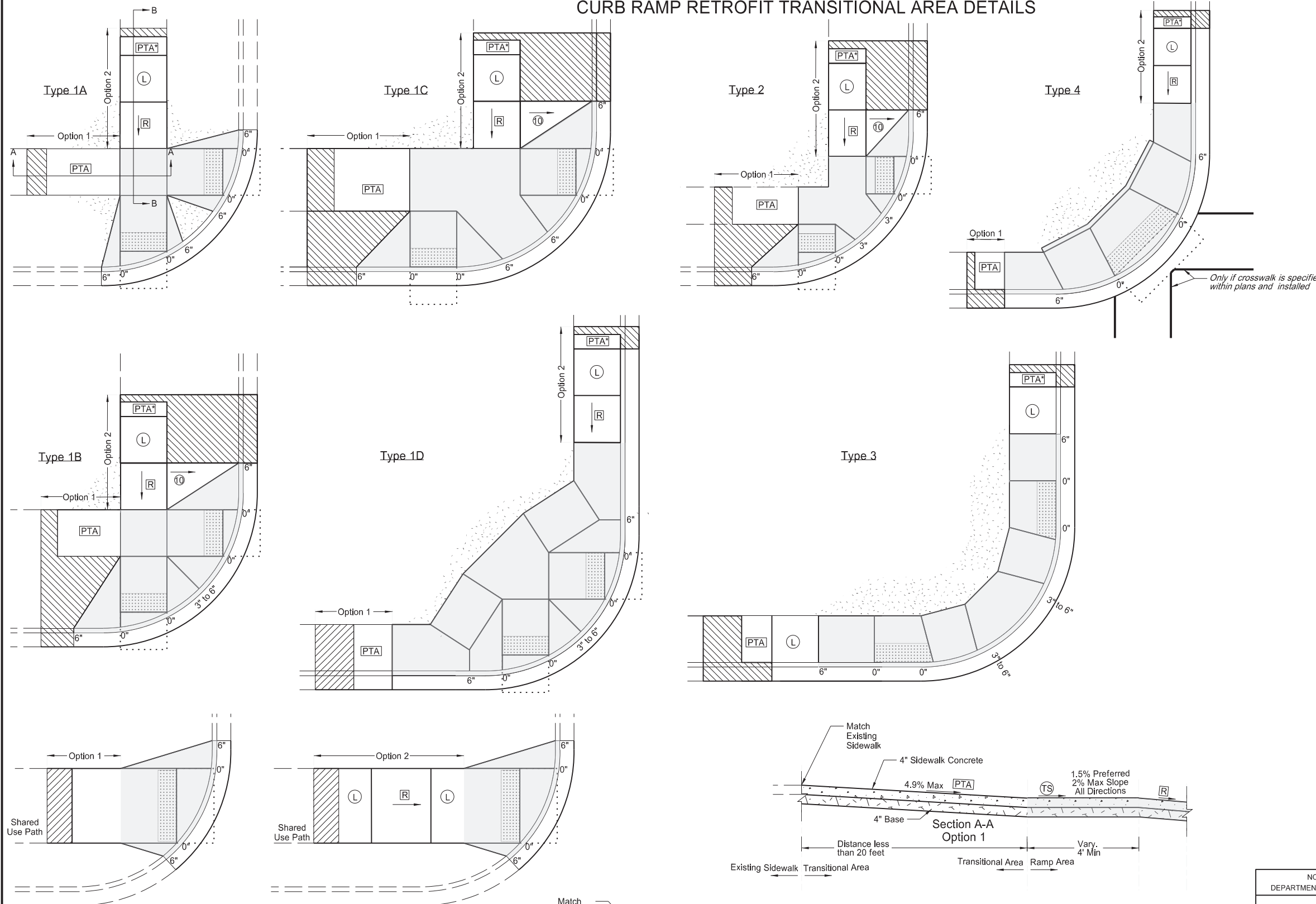

**LEGEND:**

- : Detectable Warning Panel.
- : Landscaping.
- : Transitional tie-in to nearest joint, if needed.
- : Curb Ramp Retrofit Area (See Standard Drawing D750-3)
- : 4' long x width of EPF or 4' minimum Clear space outside traffic lanes of travel. 1.5% preferred cross slope 2% maximum cross slope 4.7% preferred running slope 5% maximum running slope
- PTA** : Pedestrian Access Transition Area Running Slope less than 4.9%. Transition Cross Section at 1/2 percent per foot from the Ramp Area to EPF.
- L** **TS** : Turning Space/Landing Use at top of ramp or when changing directions. 1.5% preferred slope (2% maximum) all directions.
- R** : Preferred Ramp Grade = 5% to 7.5%. Maximum Constructed Grade = 8.3%. Preferred Cross Slope = 1.5%. Maximum Constructed Cross Slope = 2% Maximum Length = 15 feet
- 10** : 10:1 maximum constructed slope.
- 4** : 4:1 maximum constructed slope.
- 0", 3", or 6" : Curb Height.

Transition Areas for Shared Use Paths

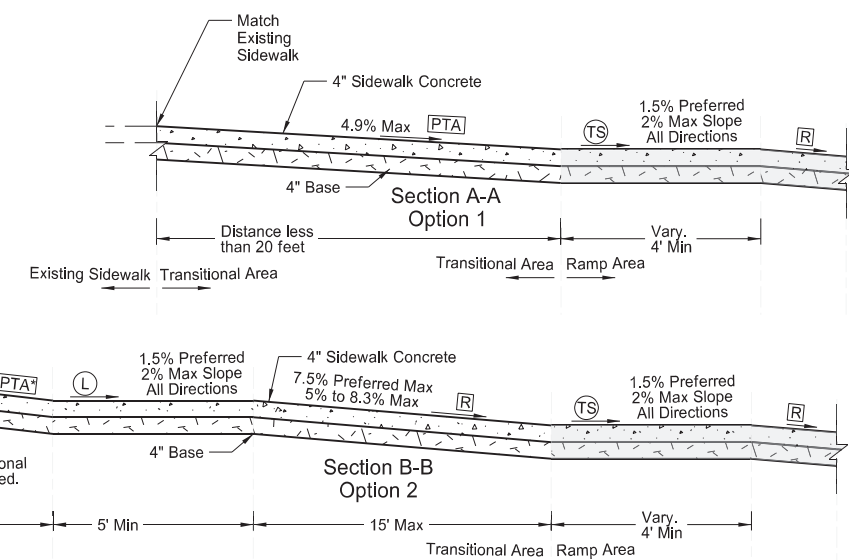

NORTH DAKOTA DEPARTMENT OF TRANSPORTATION	
05-19-21	
REVISIONS	
DATE	CHANGE

KIRK J. HOFF

REGISTERED

Kirk J Hoff

PROFESSIONAL

PE-4683

ENGINEER

NORTH DAKOTA

05 19 2021