

STATE	PROJECT NO.	SECTION NO.	SHEET NO.
ND	HEU-8-984(179)	200	3

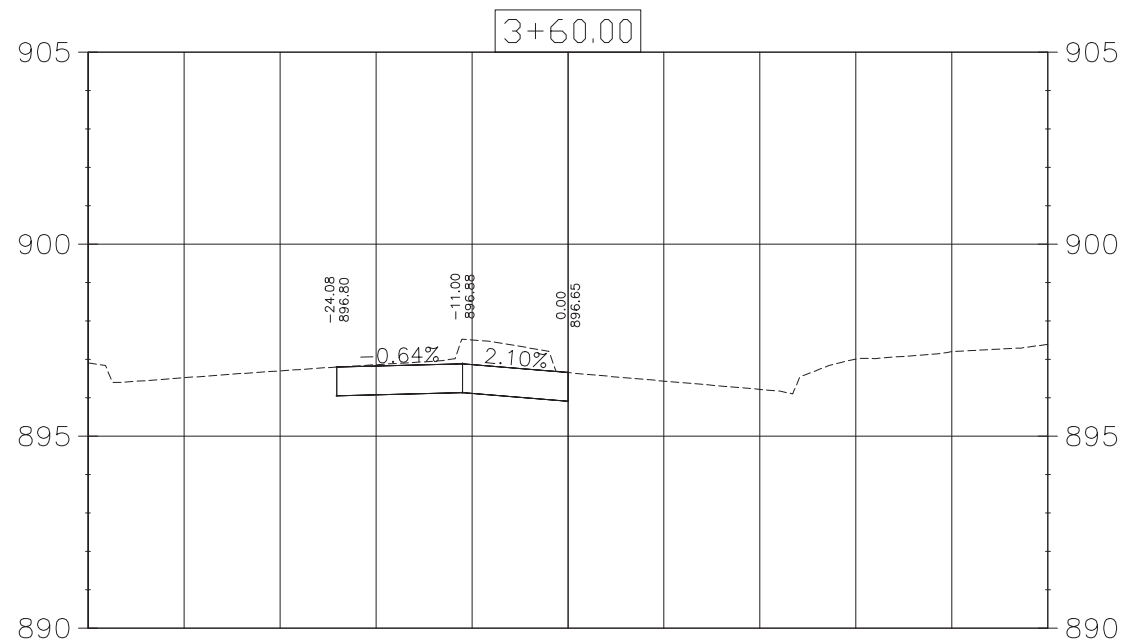

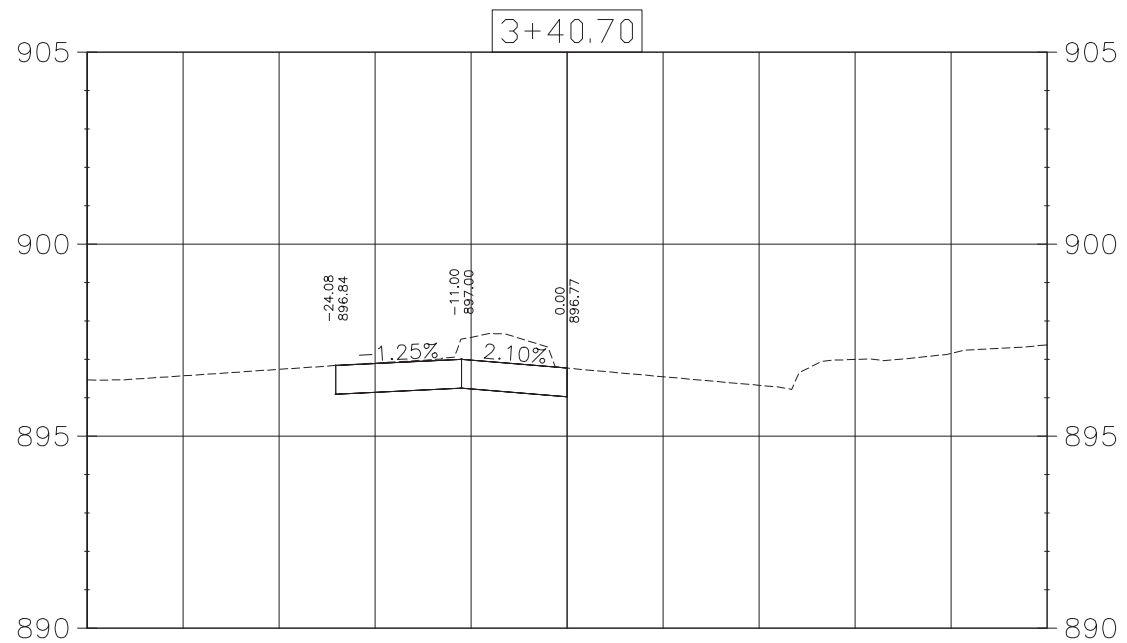

	STATE	PROJECT NO.	SECTION NO.	SHEET NO.
	ND	HEU-8-984(179)	200	5

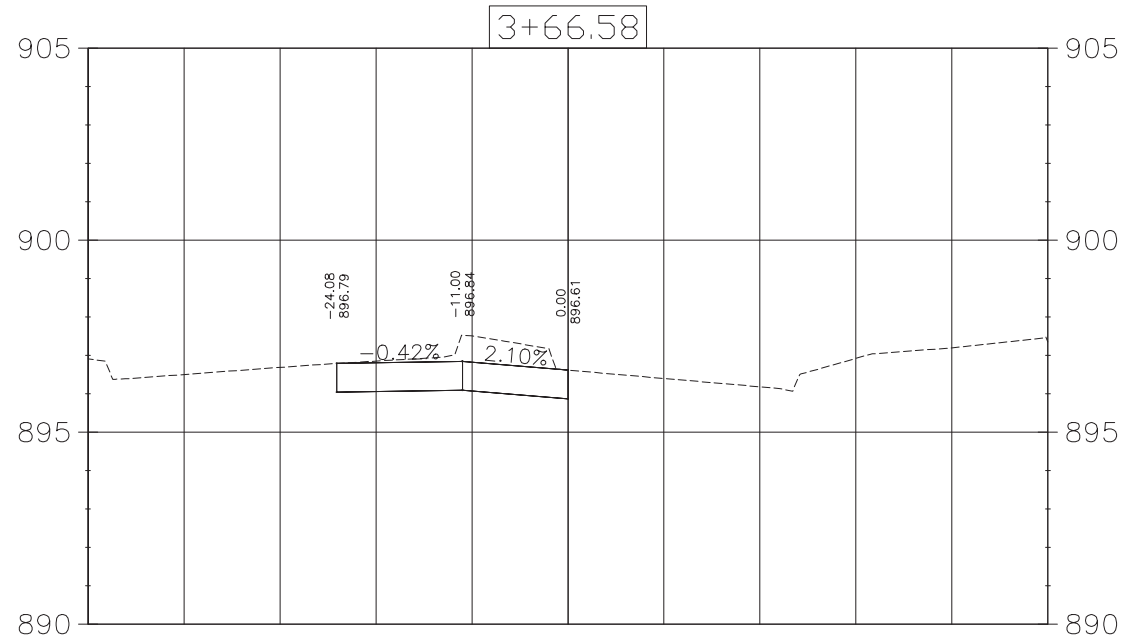
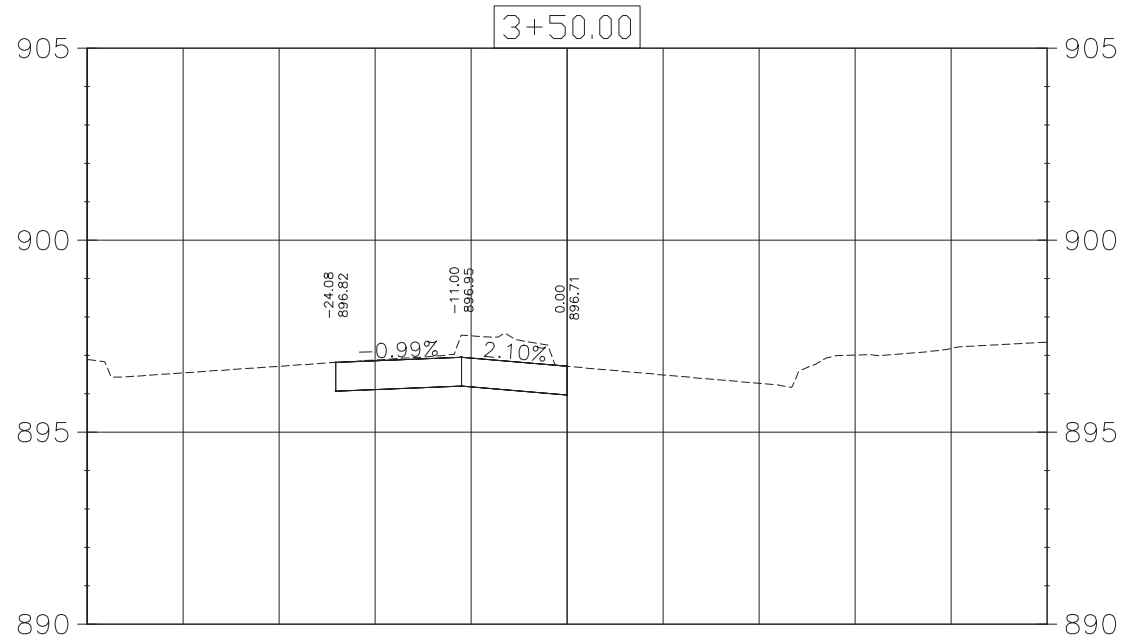
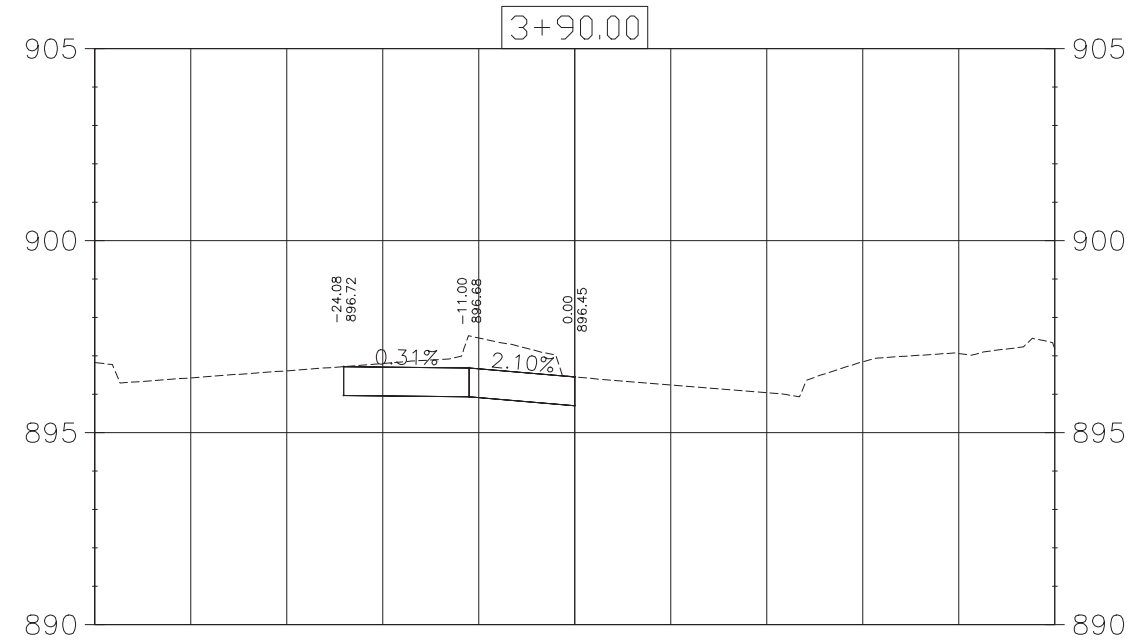
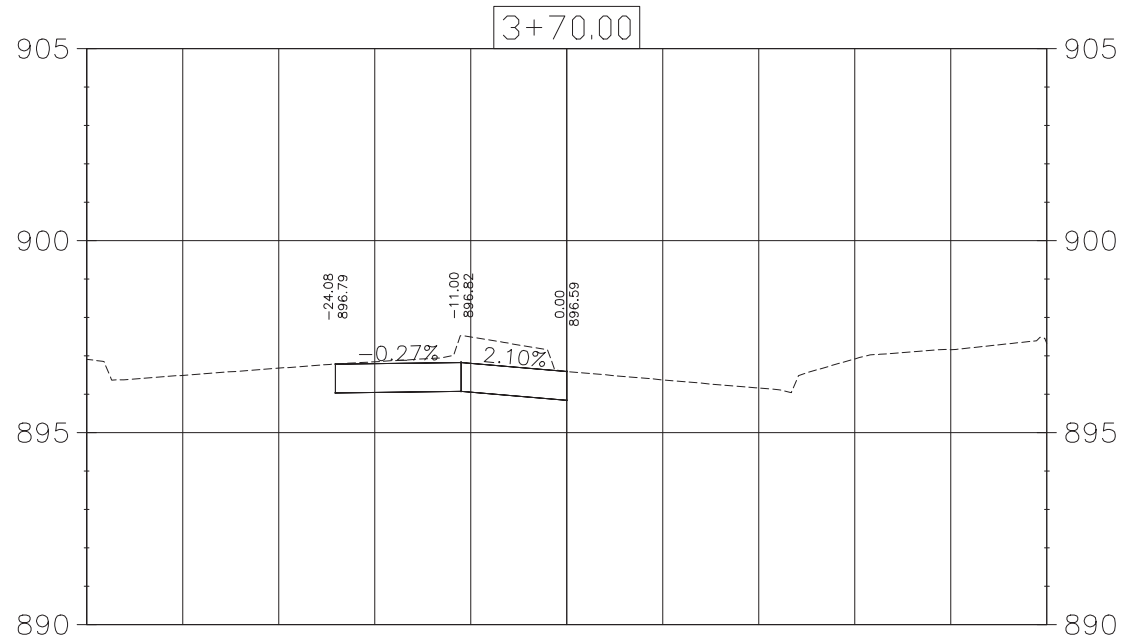
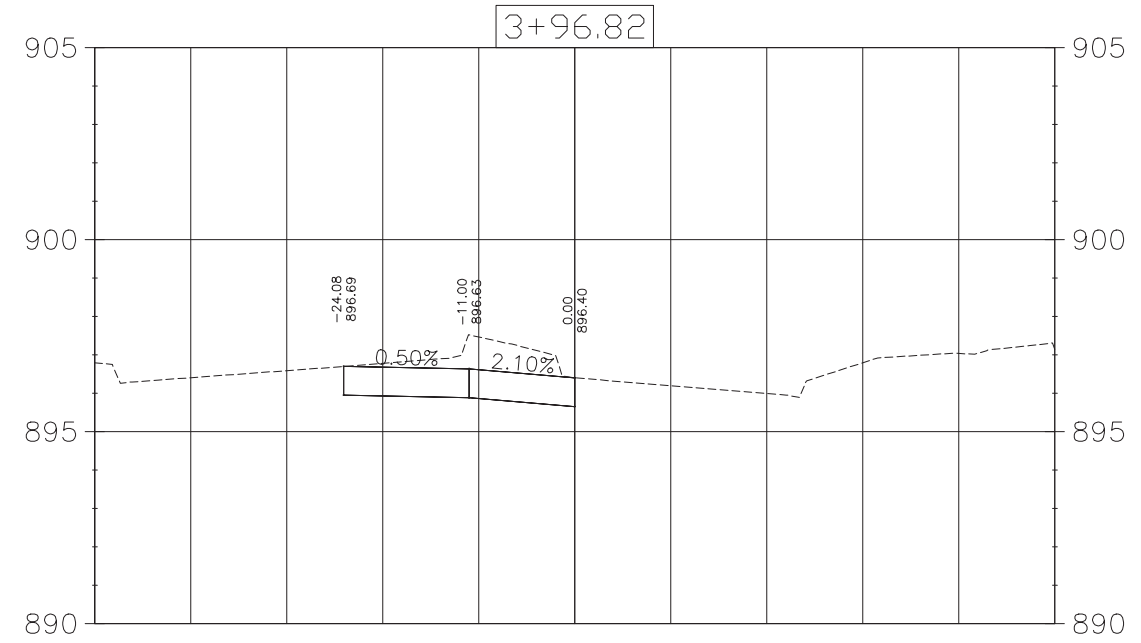
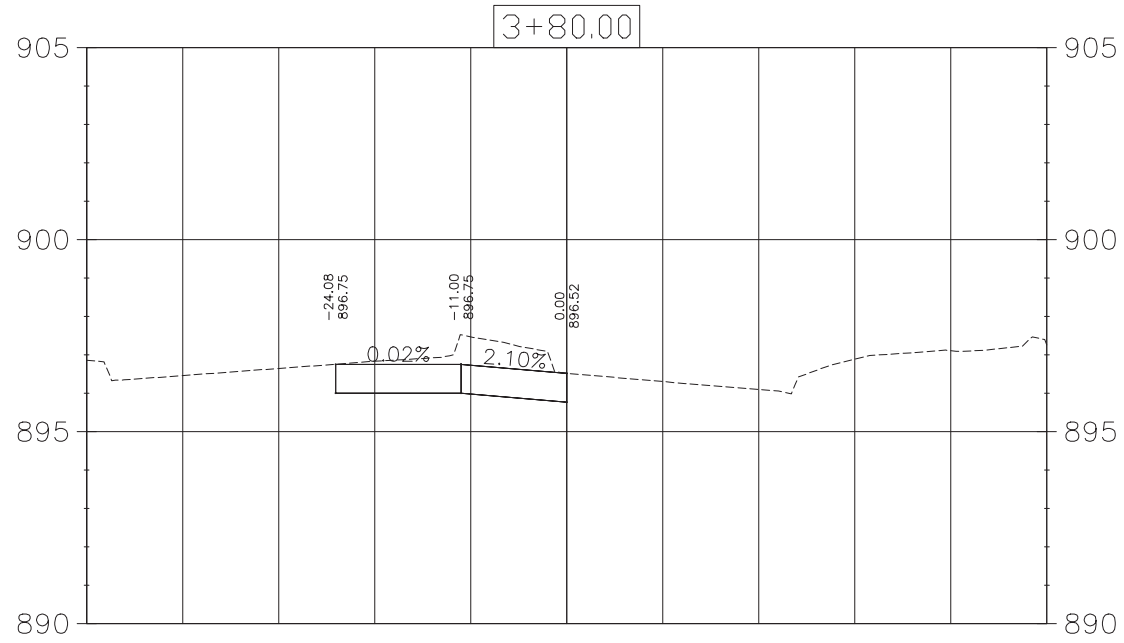
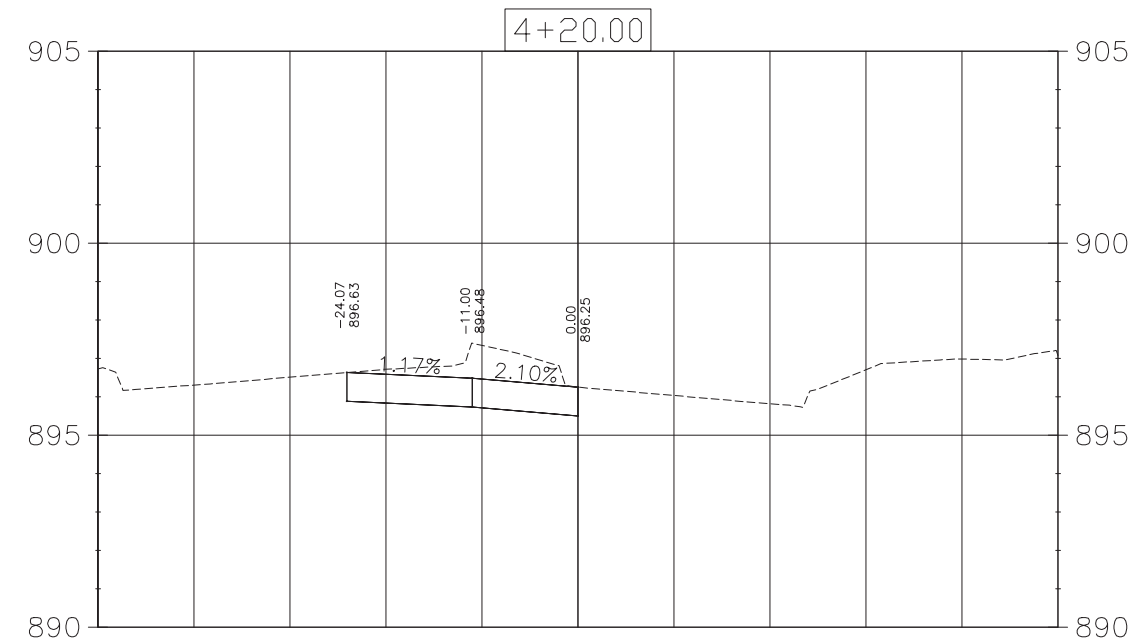
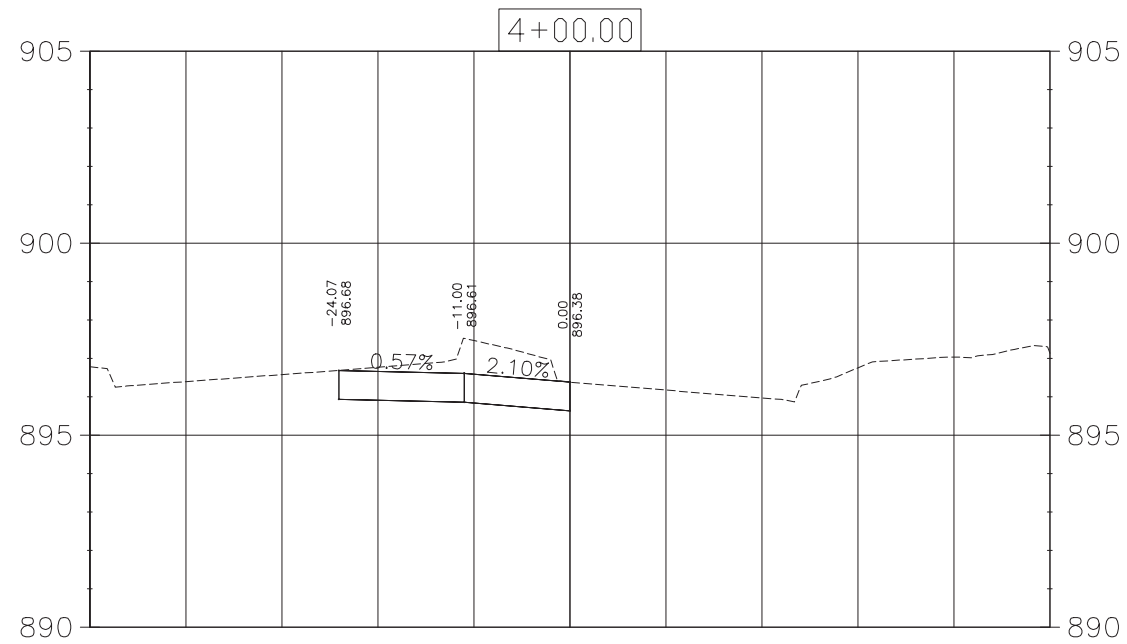
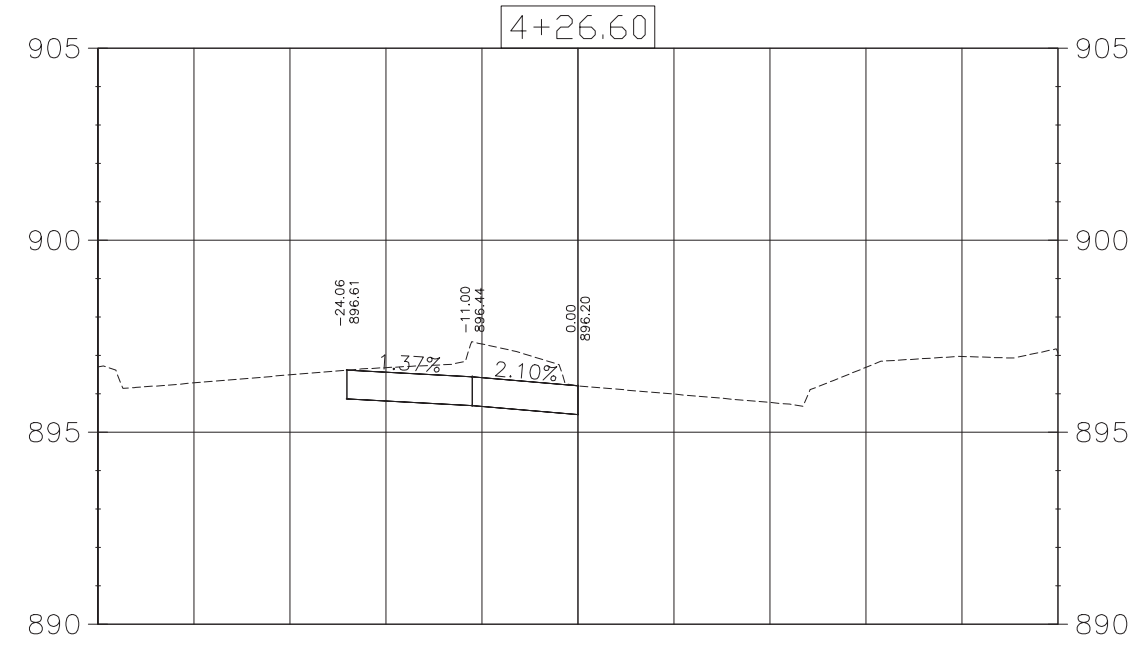
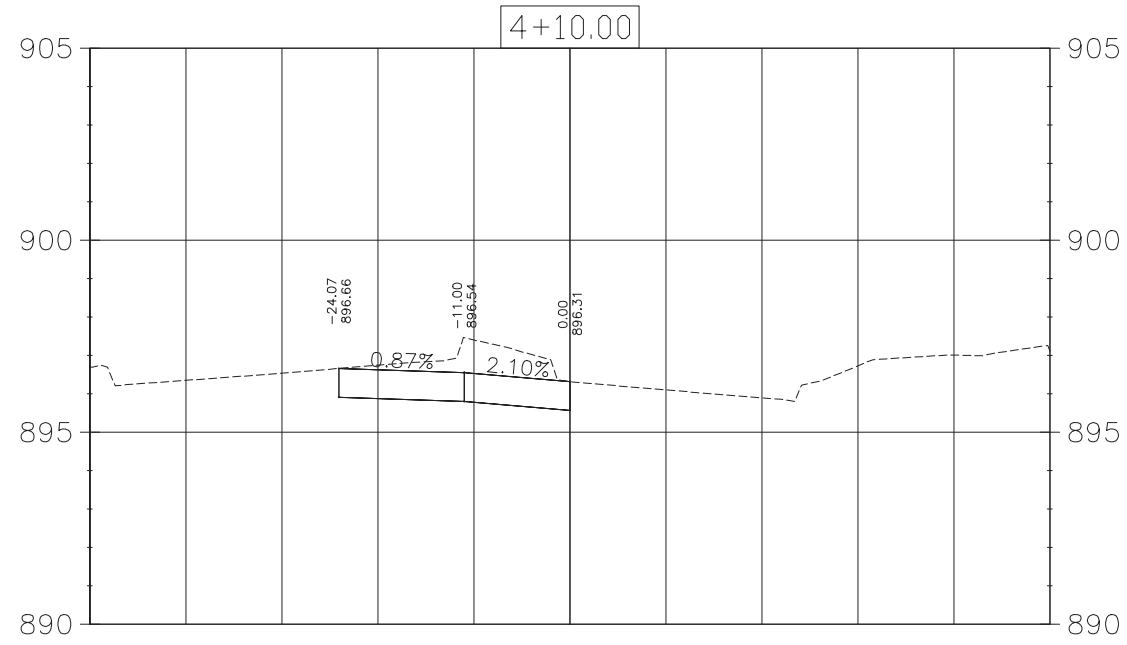

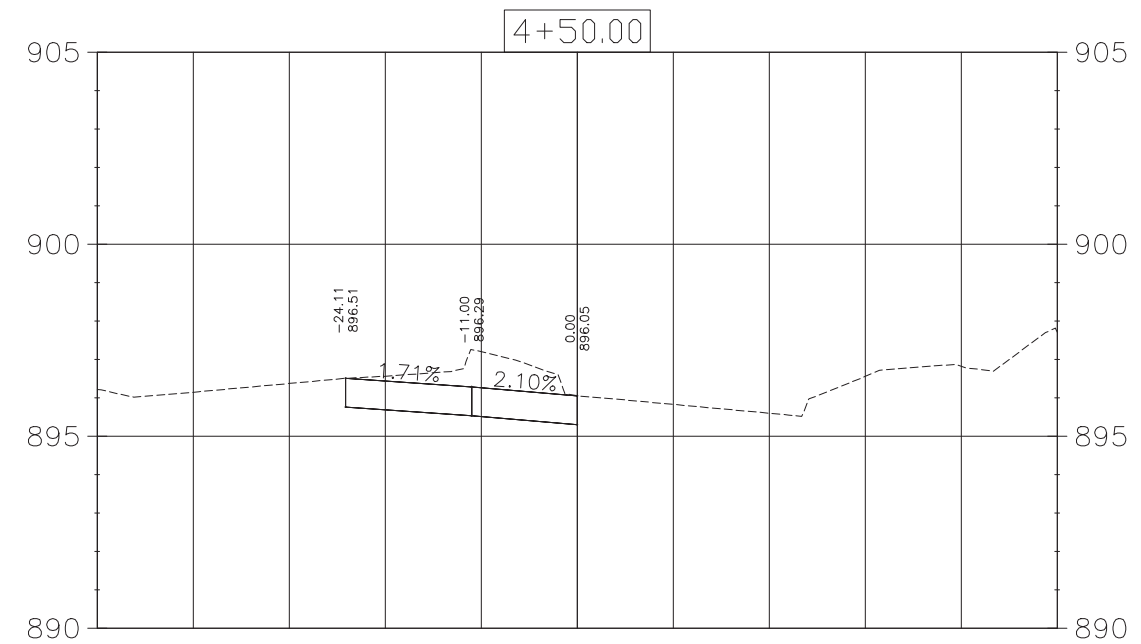
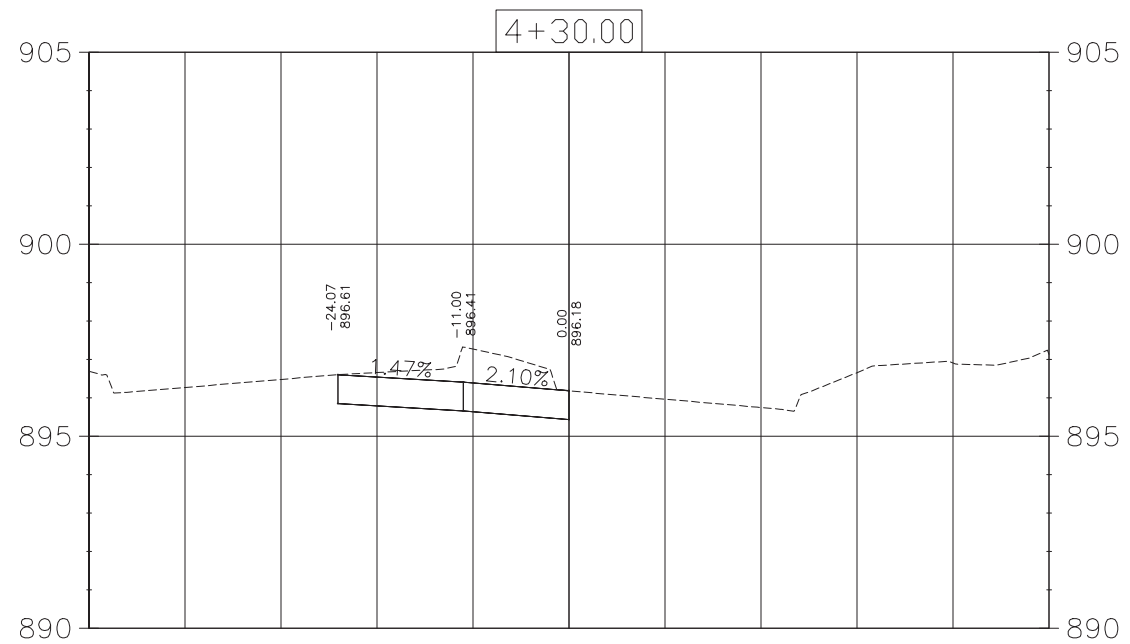
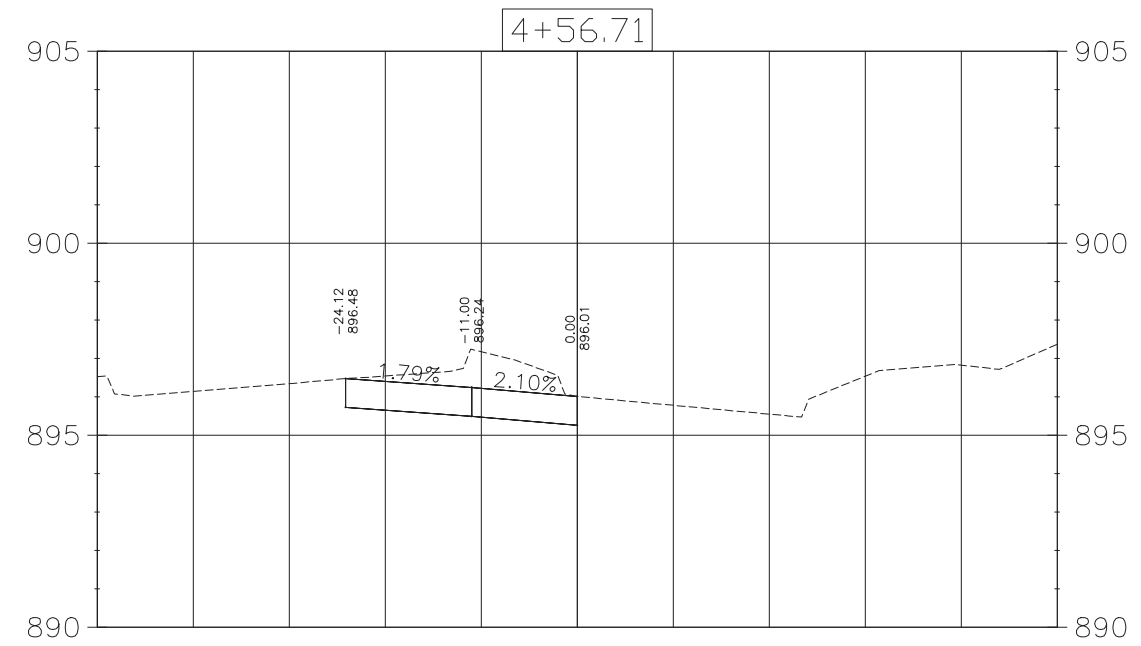
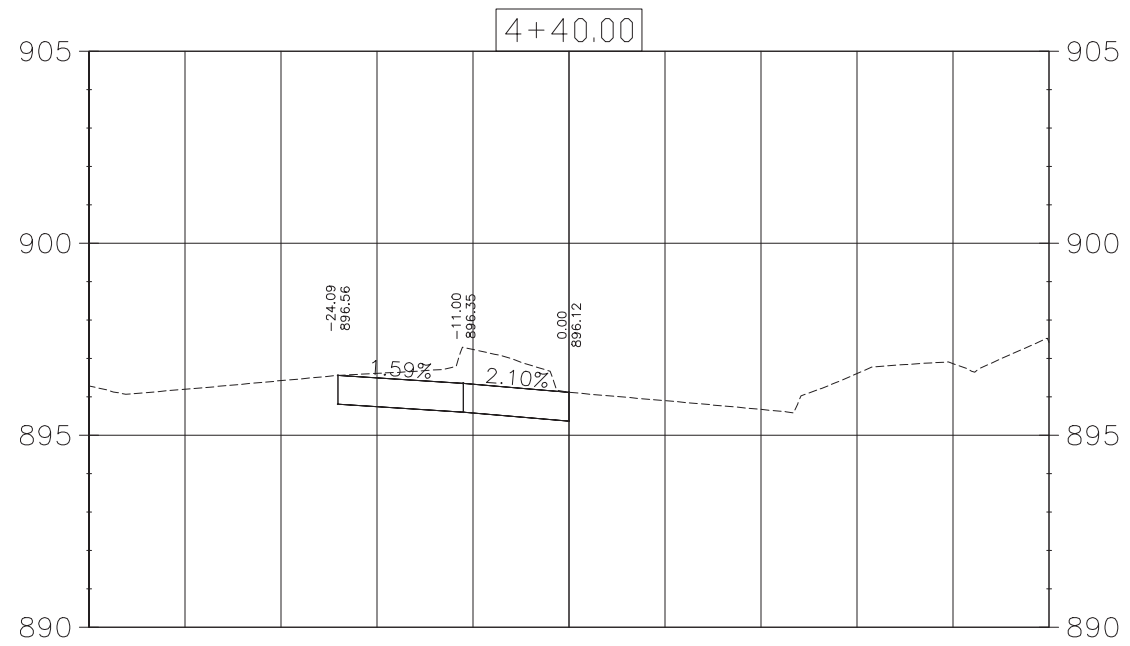

STATE	PROJECT NO.	SECTION NO.	SHEET NO.
ND	HEU-8-984(179)	200	7

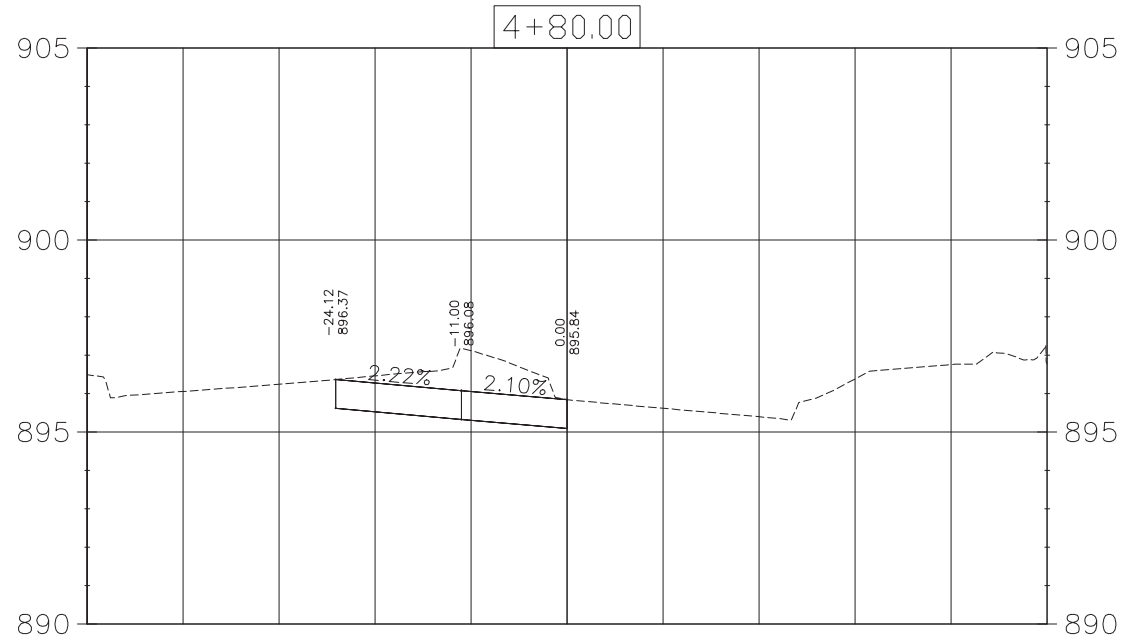
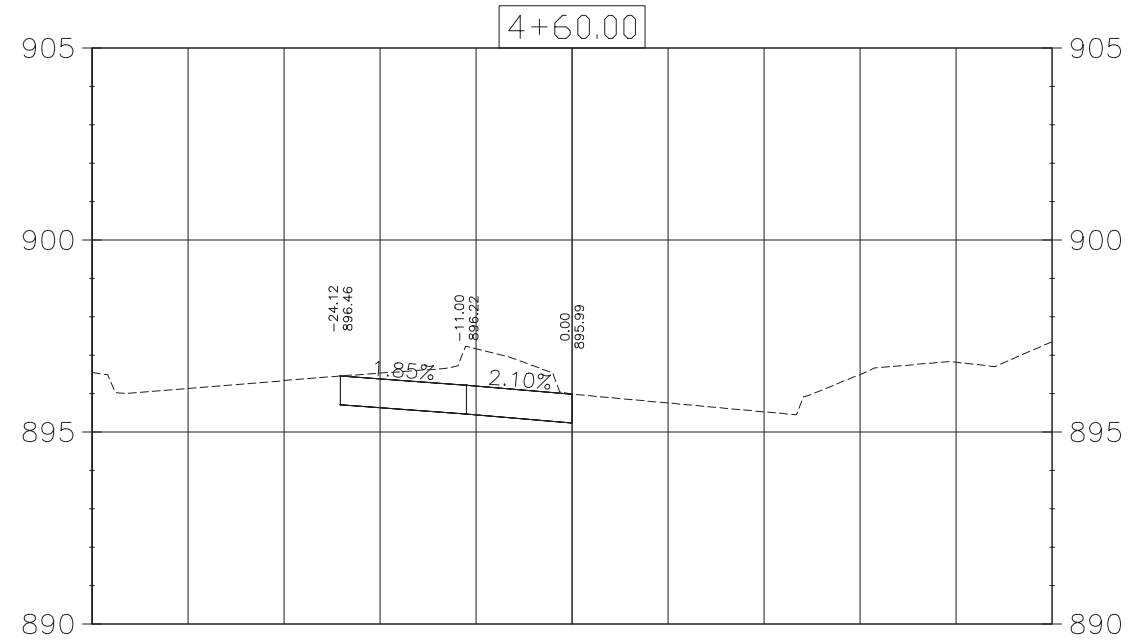
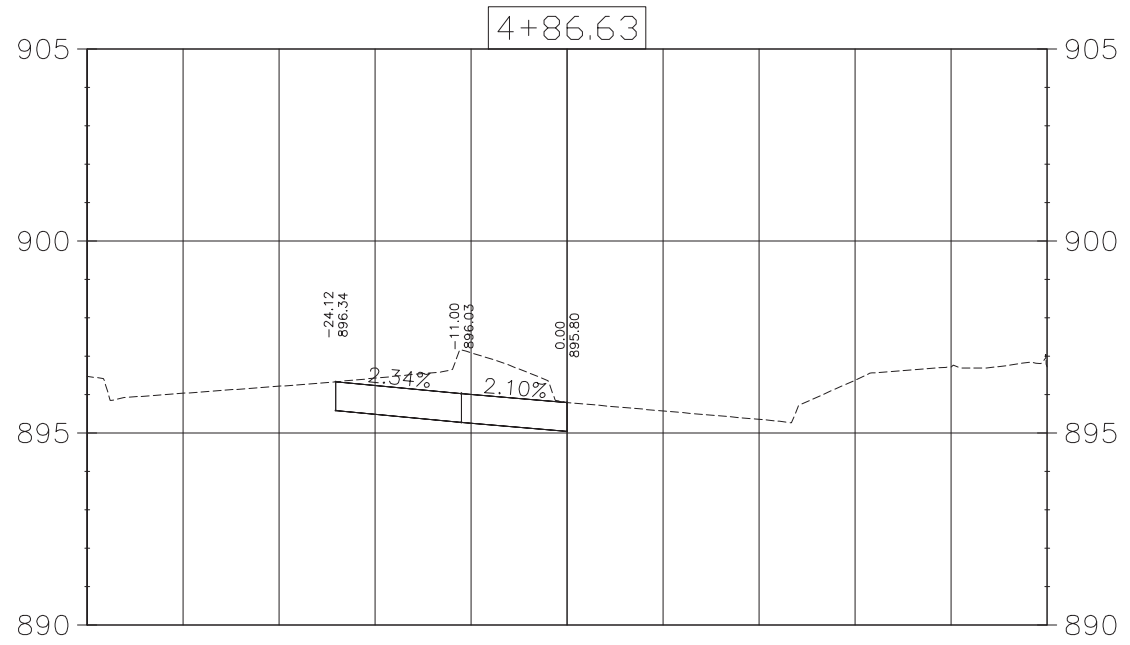
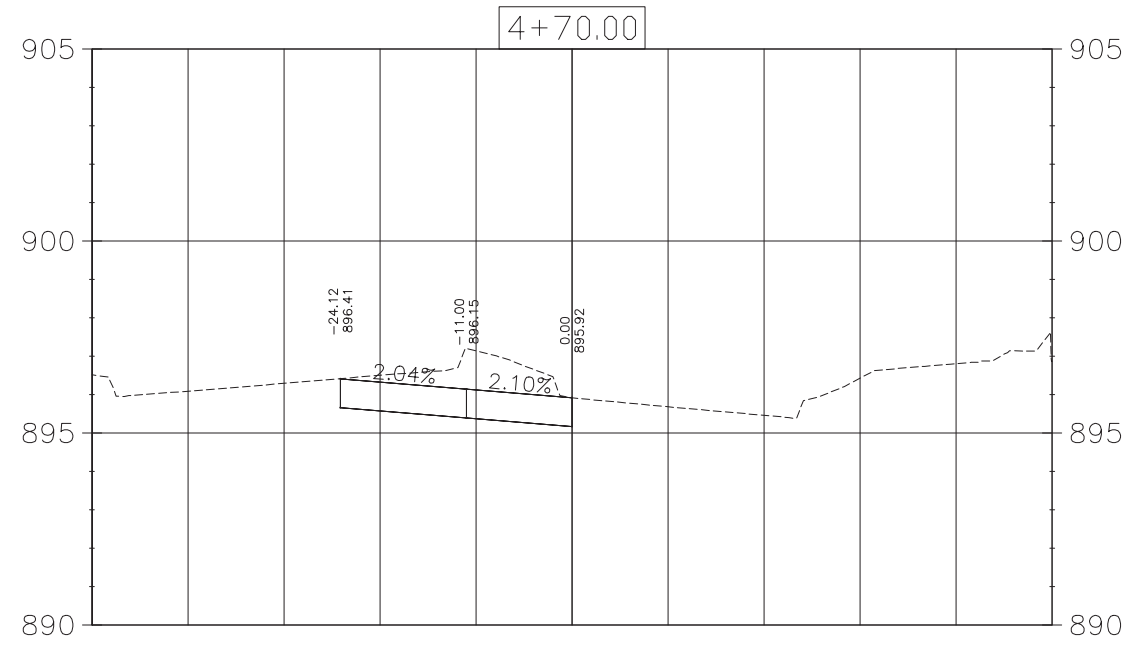

STATE	PROJECT NO.	SECTION NO.	SHEET NO.
ND	HEU-8-984(179)	200	8

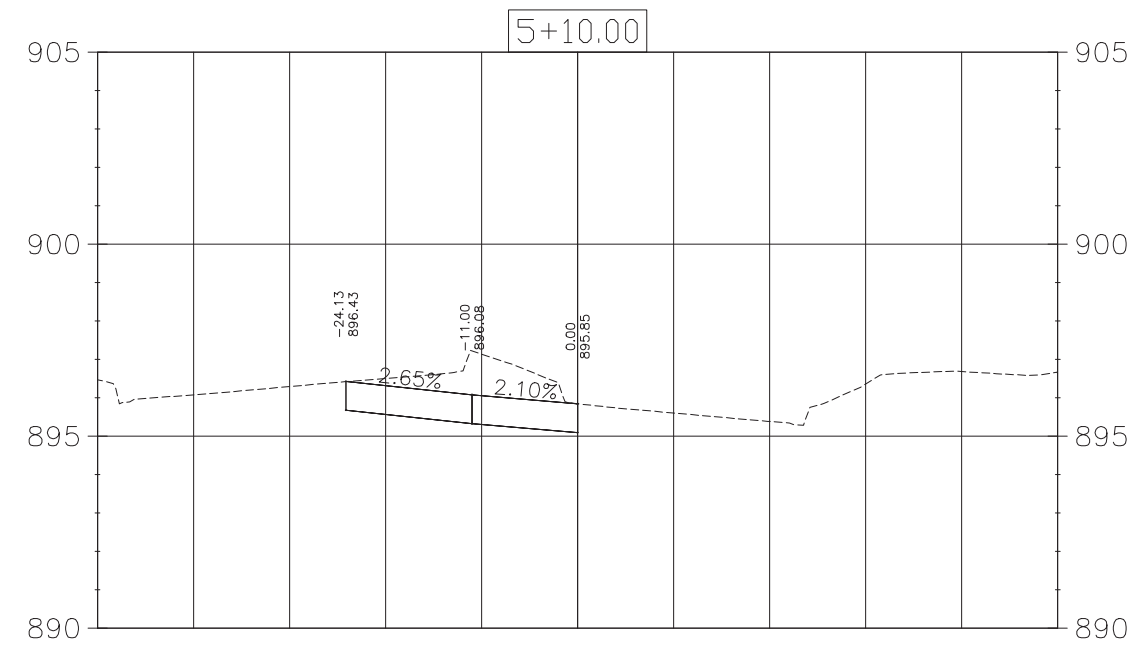
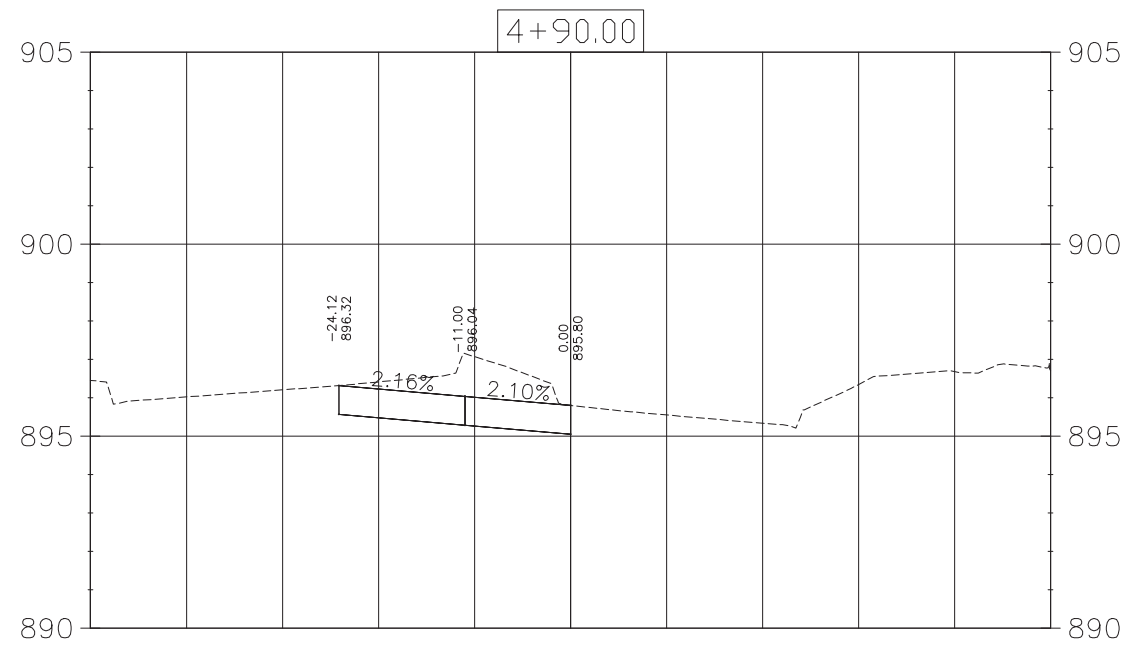
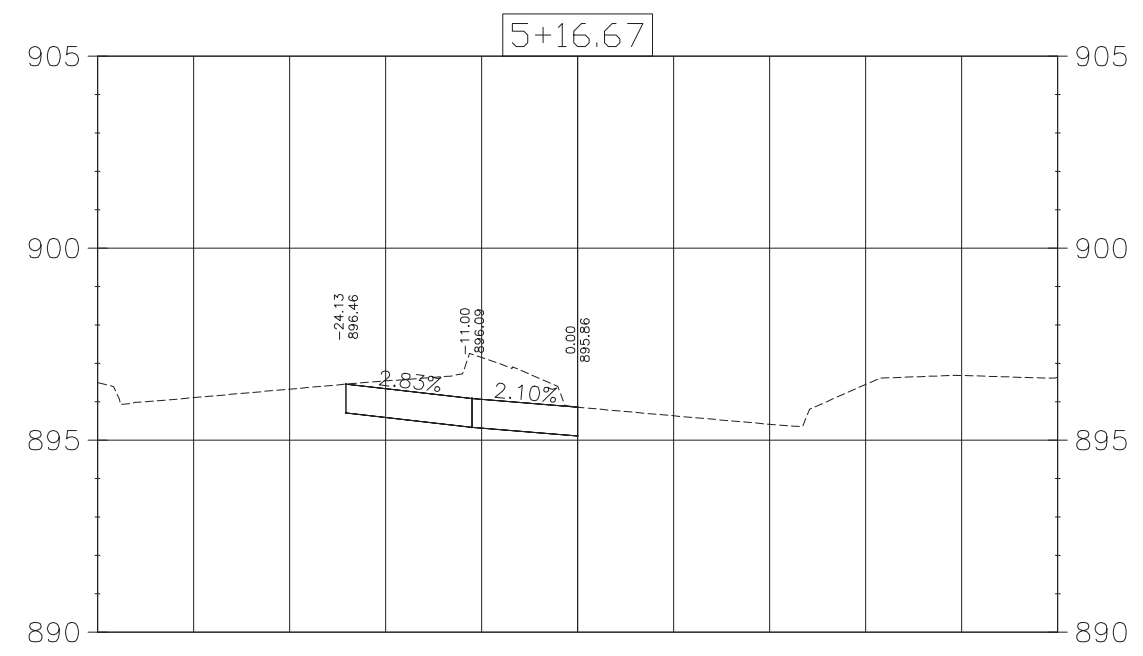
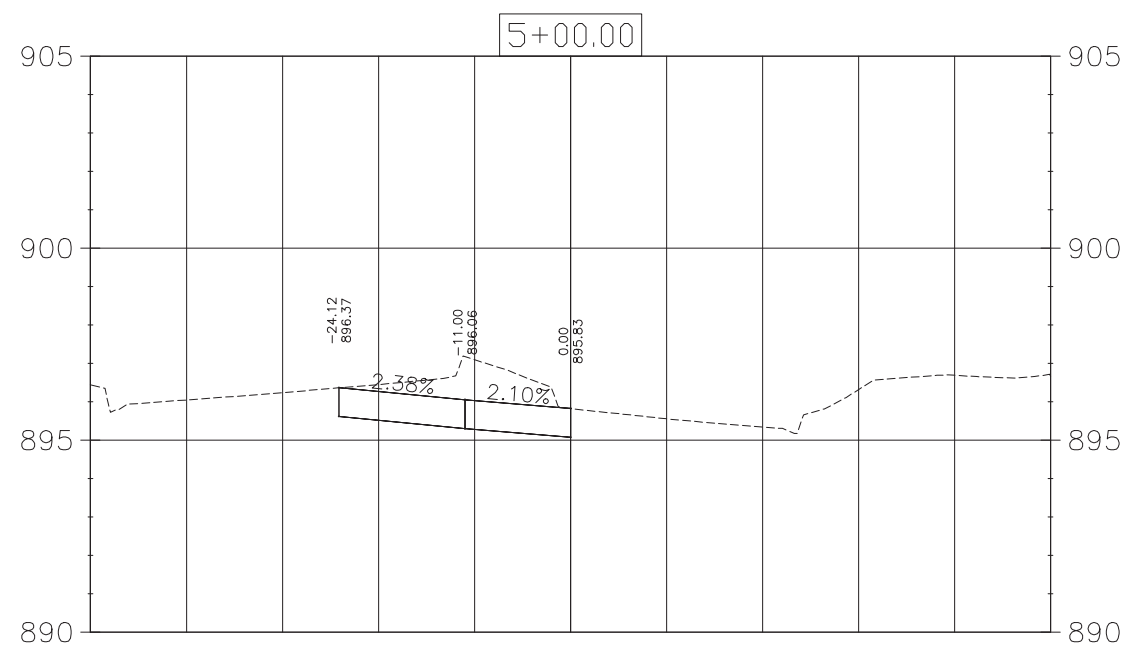

STATE	PROJECT NO.	SECTION NO.	SHEET NO.
ND	HEU-8-984(179)	200	9

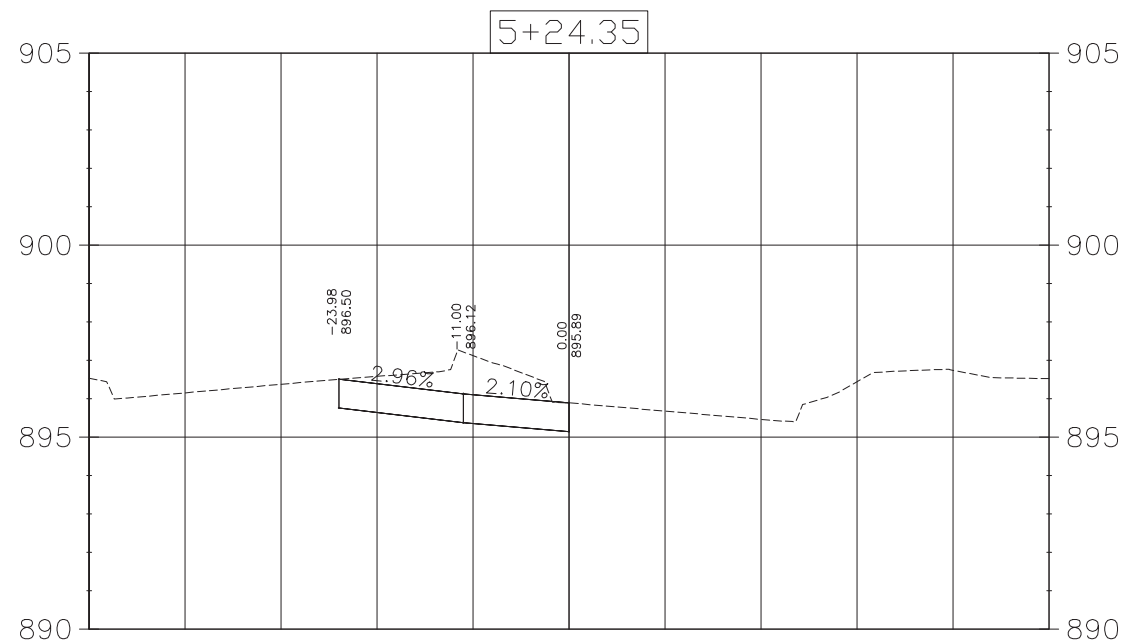
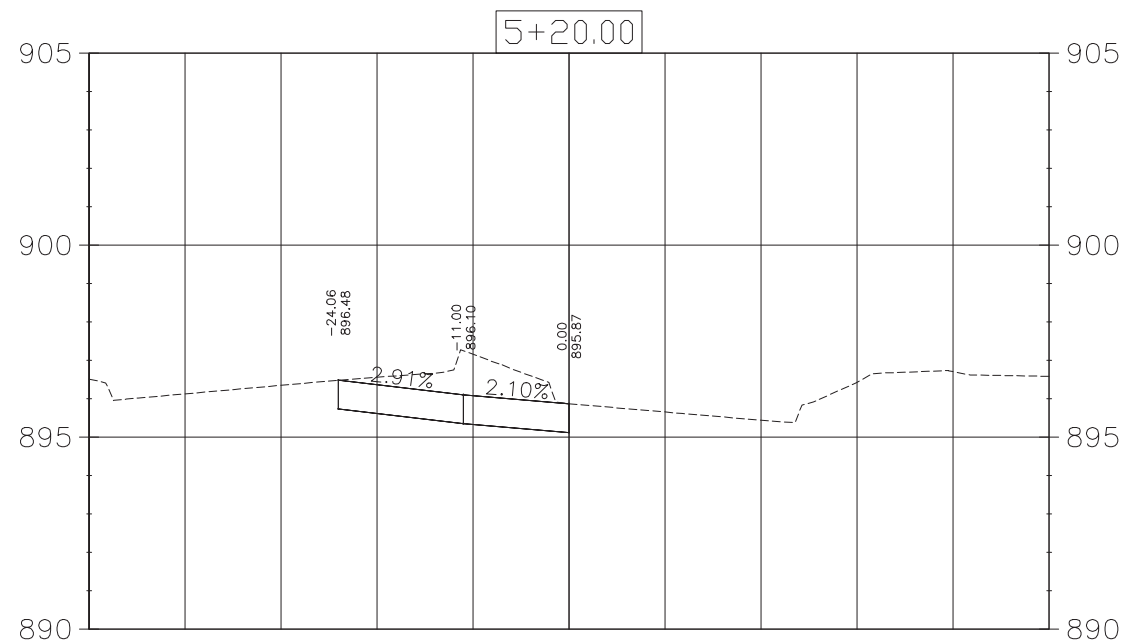
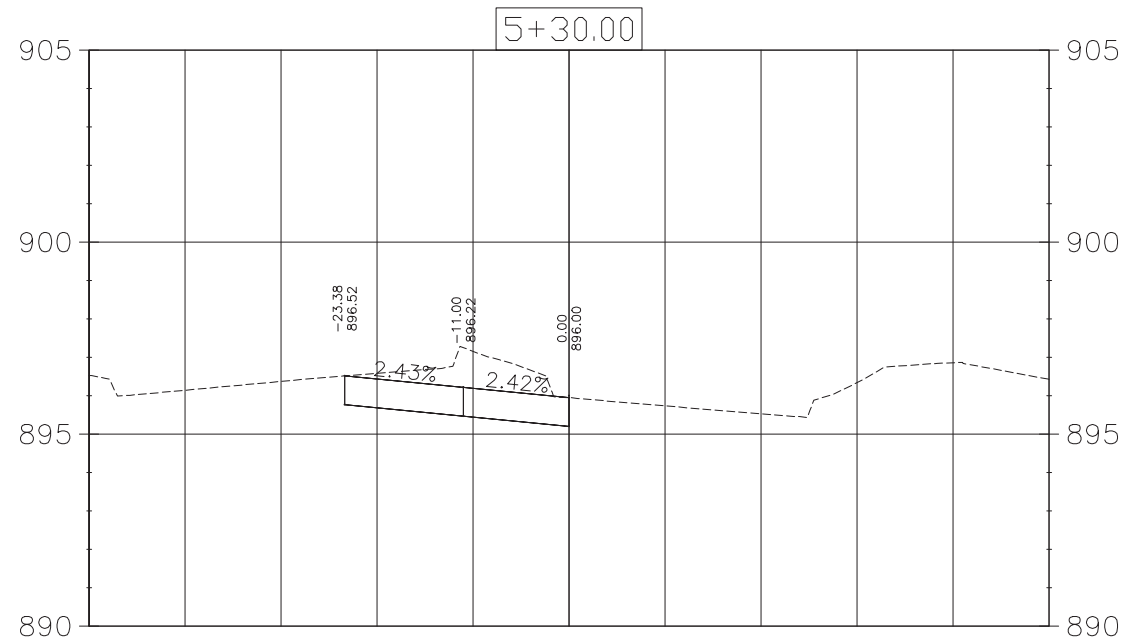
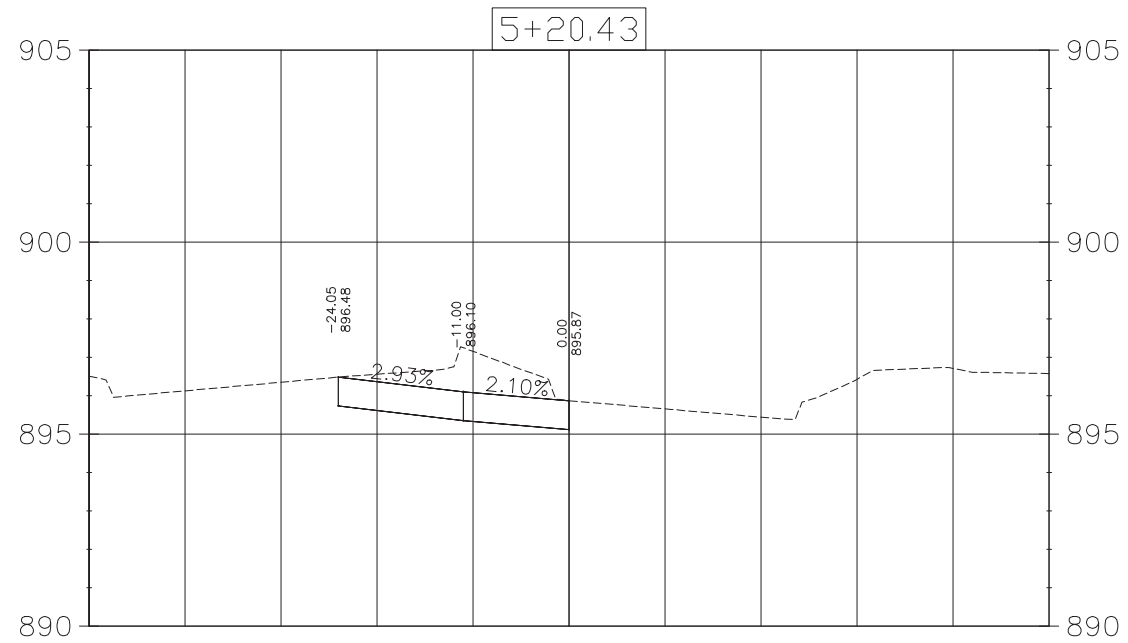

	STATE	PROJECT NO.	SECTION NO.	SHEET NO.
	ND	HEU-8-984(179)	200	10

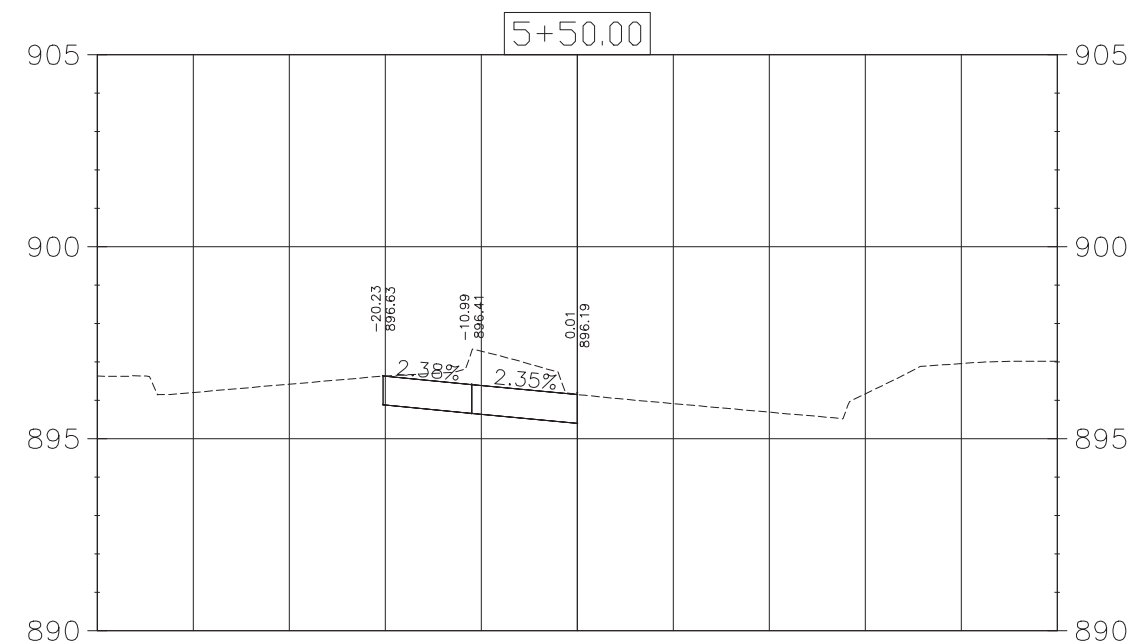
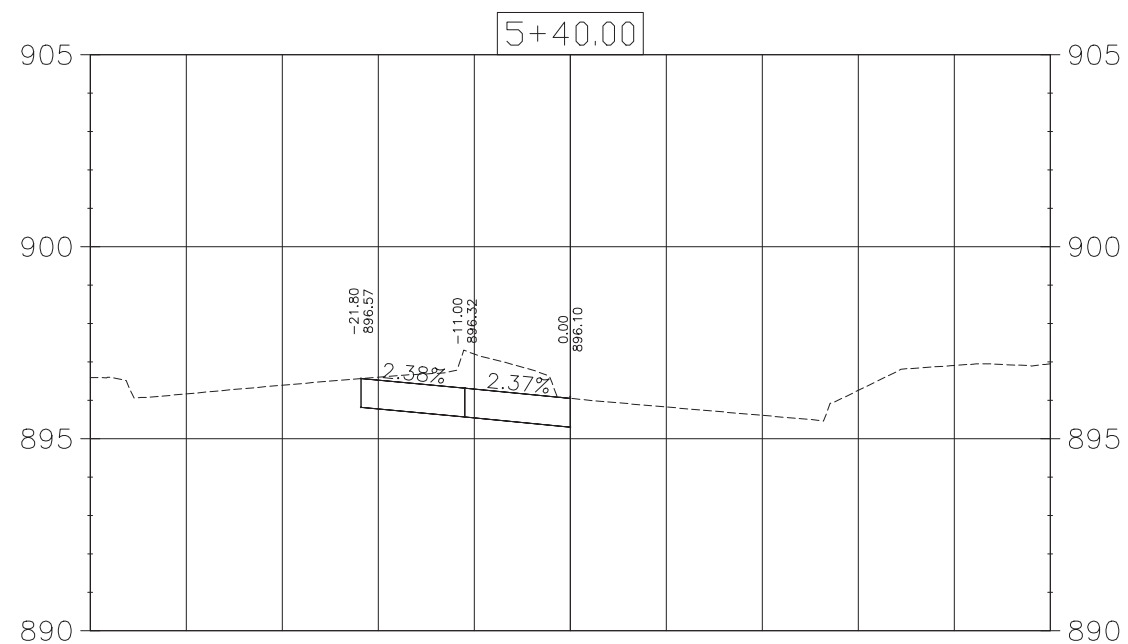
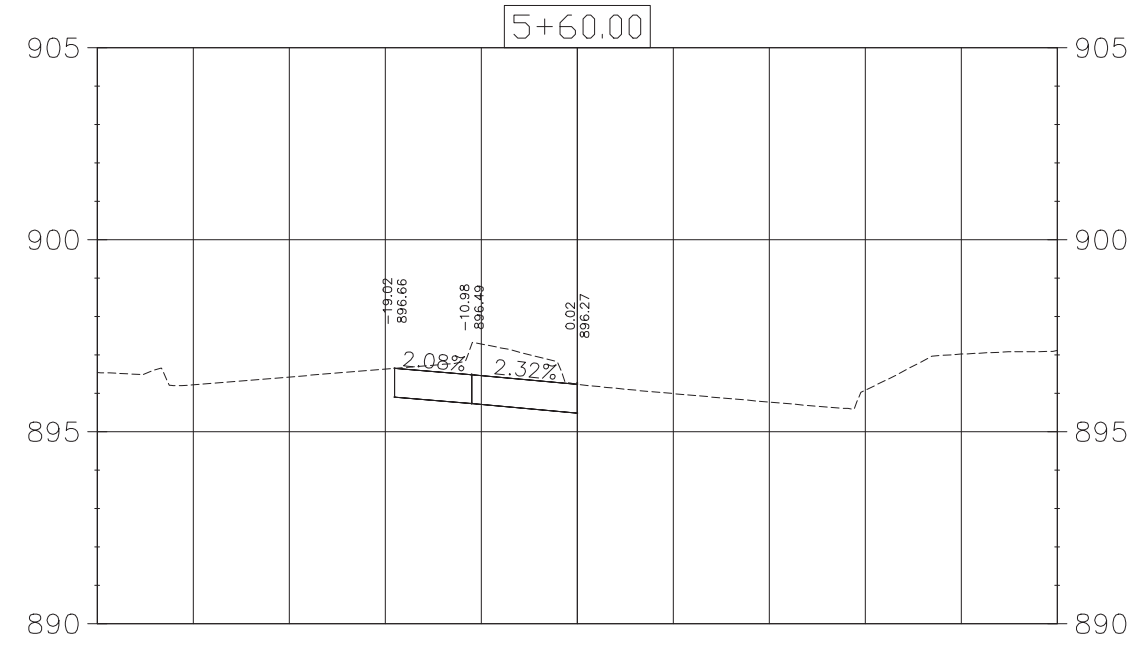
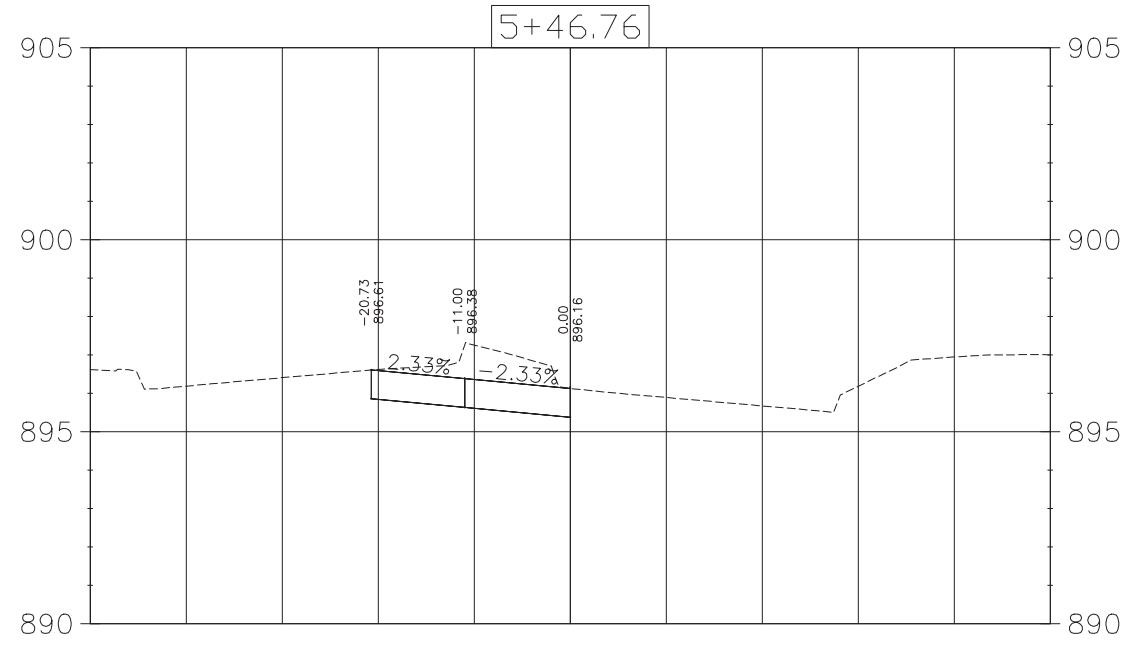

	STATE	PROJECT NO.	SECTION NO.	SHEET NO.
	ND	HEU-8-984(179)	200	11

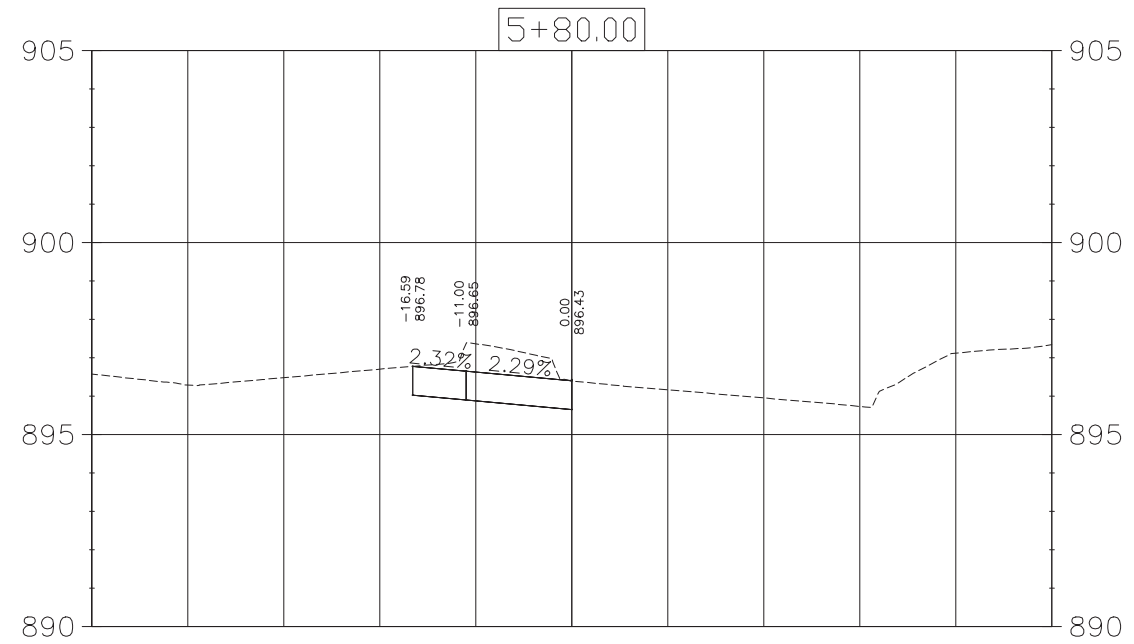
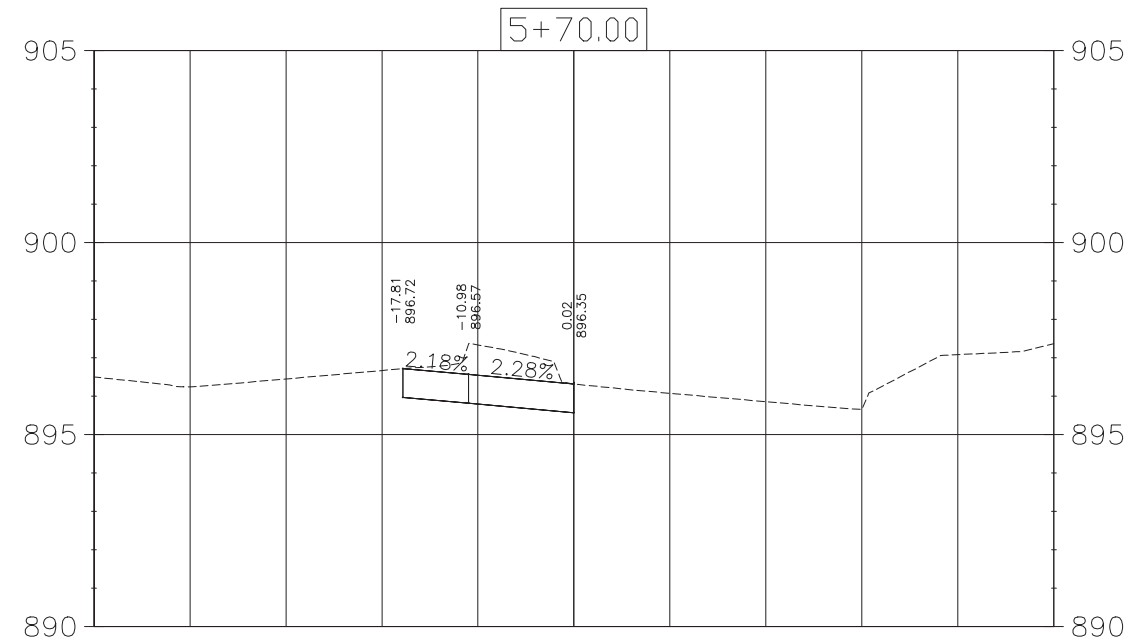
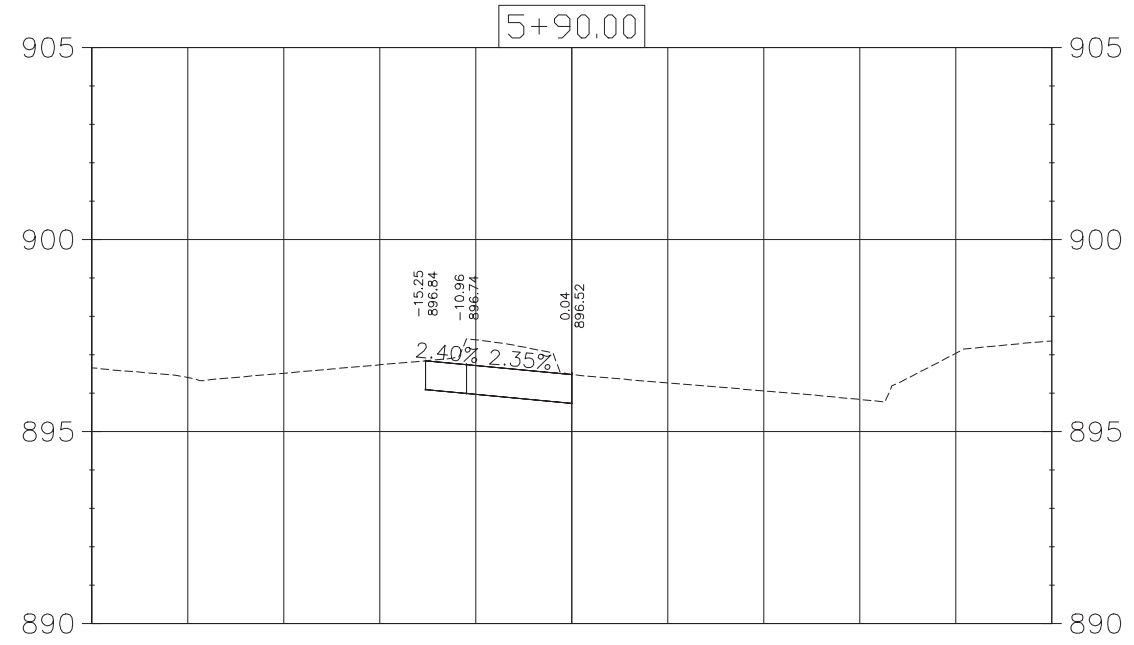
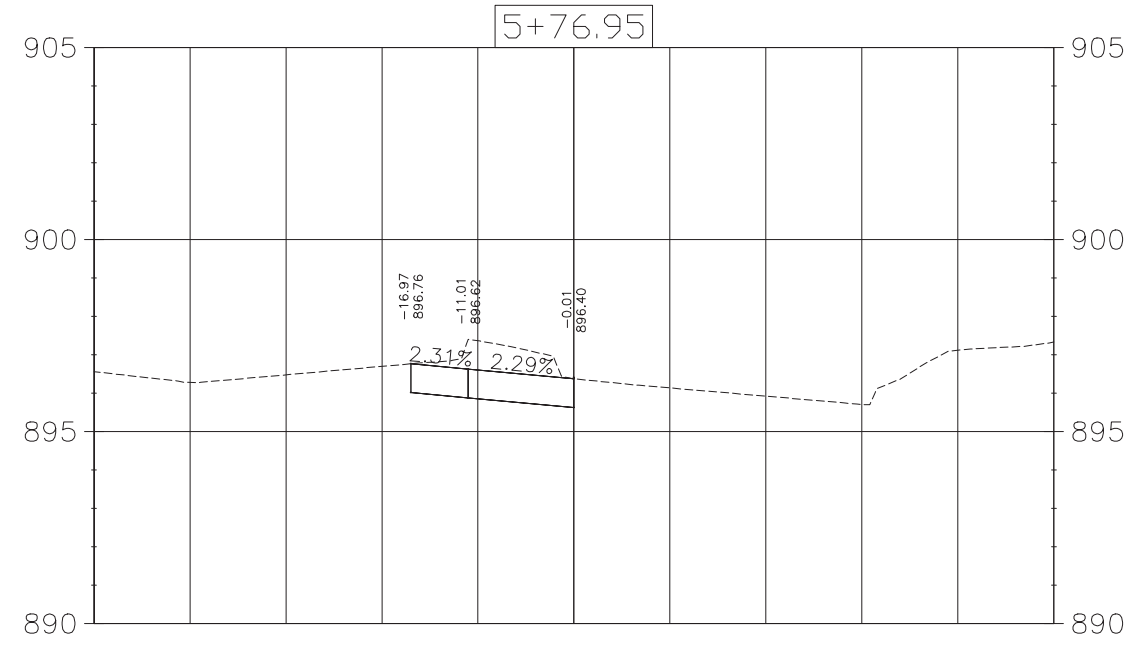

	STATE	PROJECT NO.	SECTION NO.	SHEET NO.
	ND	HEU-8-984(179)	200	12

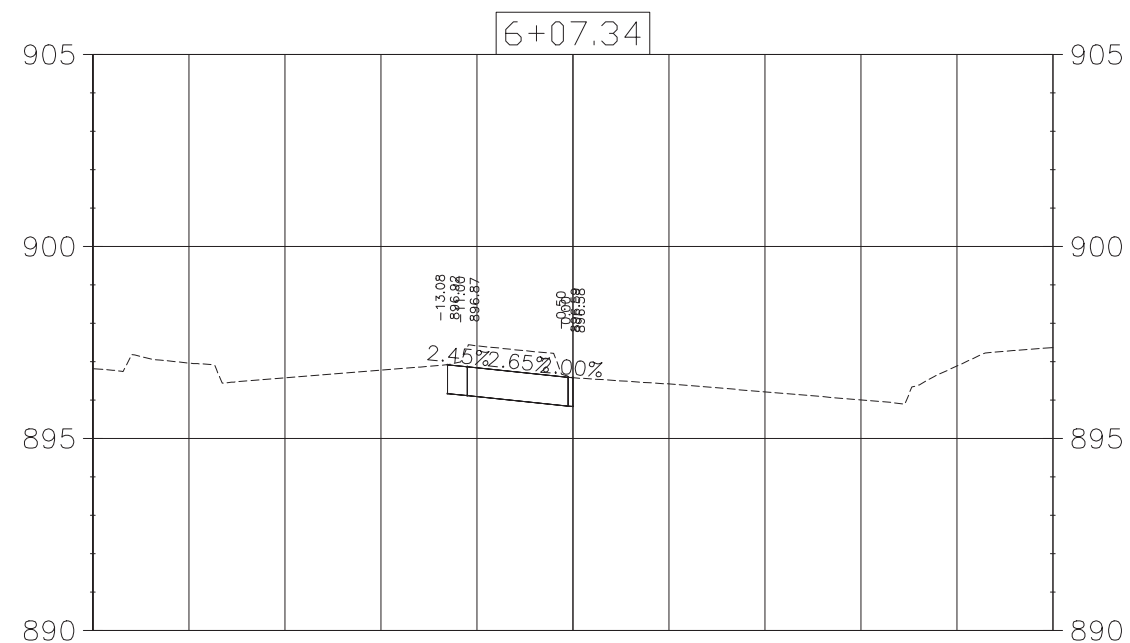
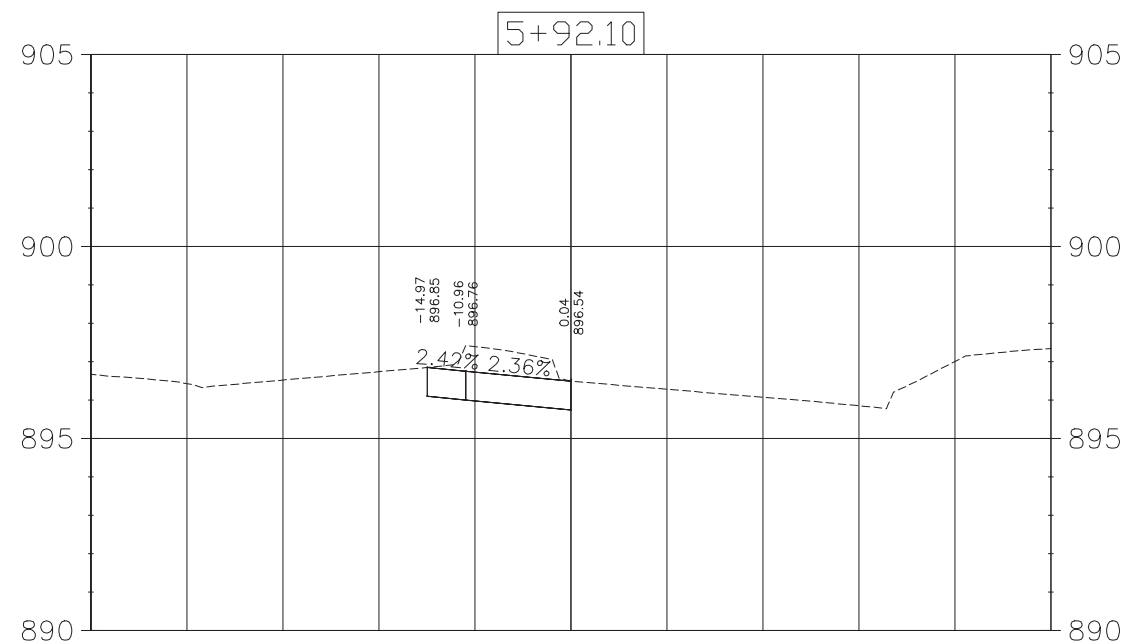
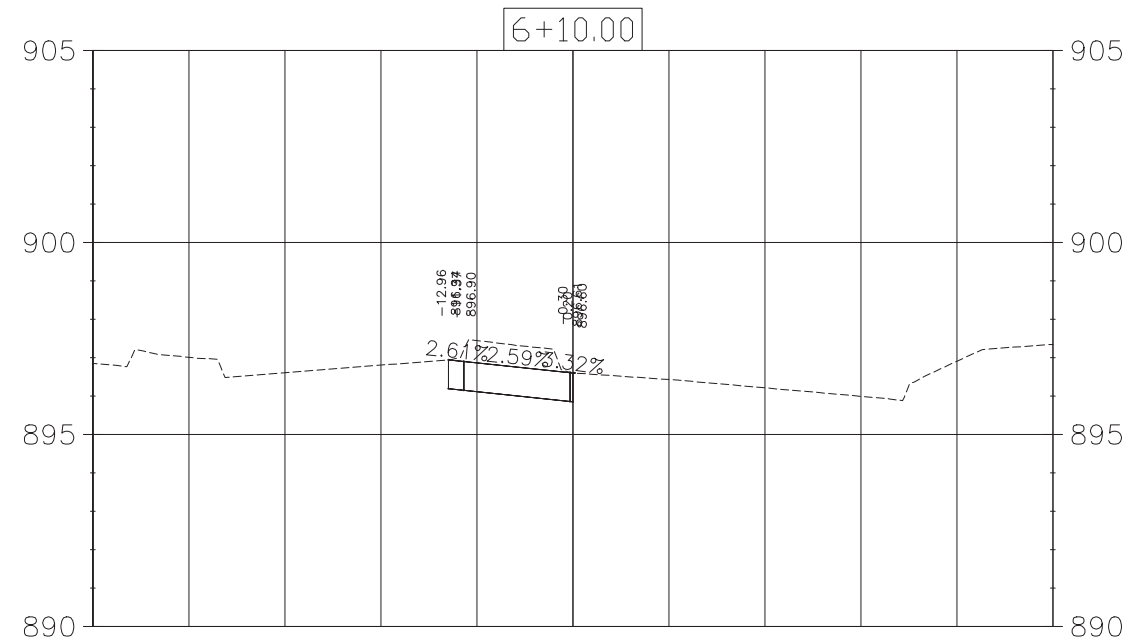
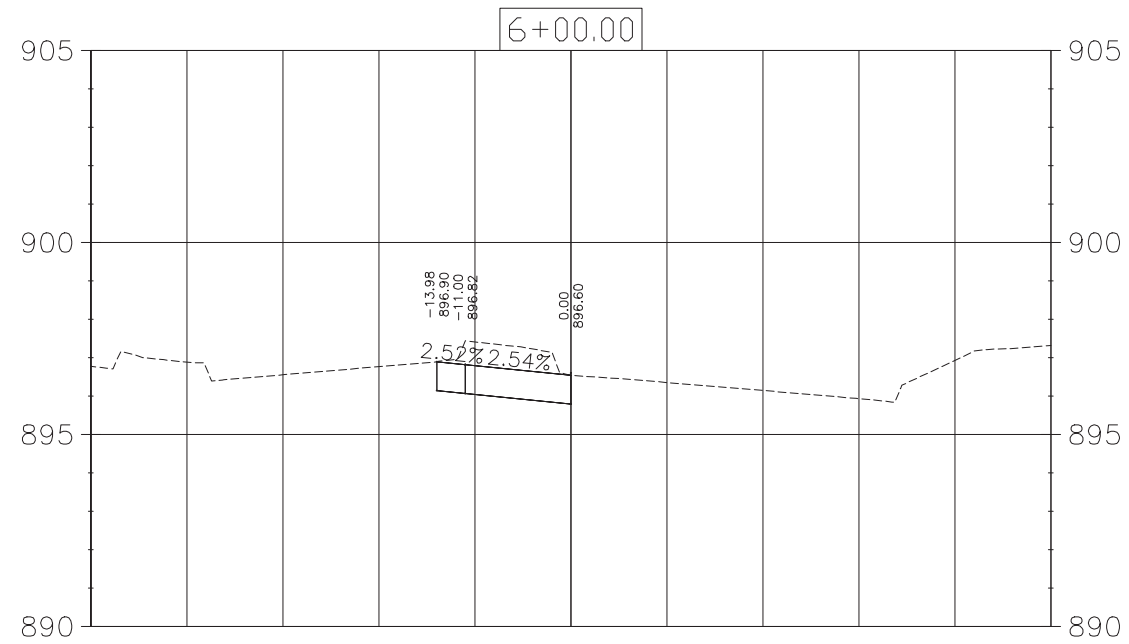

	STATE	PROJECT NO.	SECTION NO.	SHEET NO.
	ND	HEU-8-984(179)	200	13

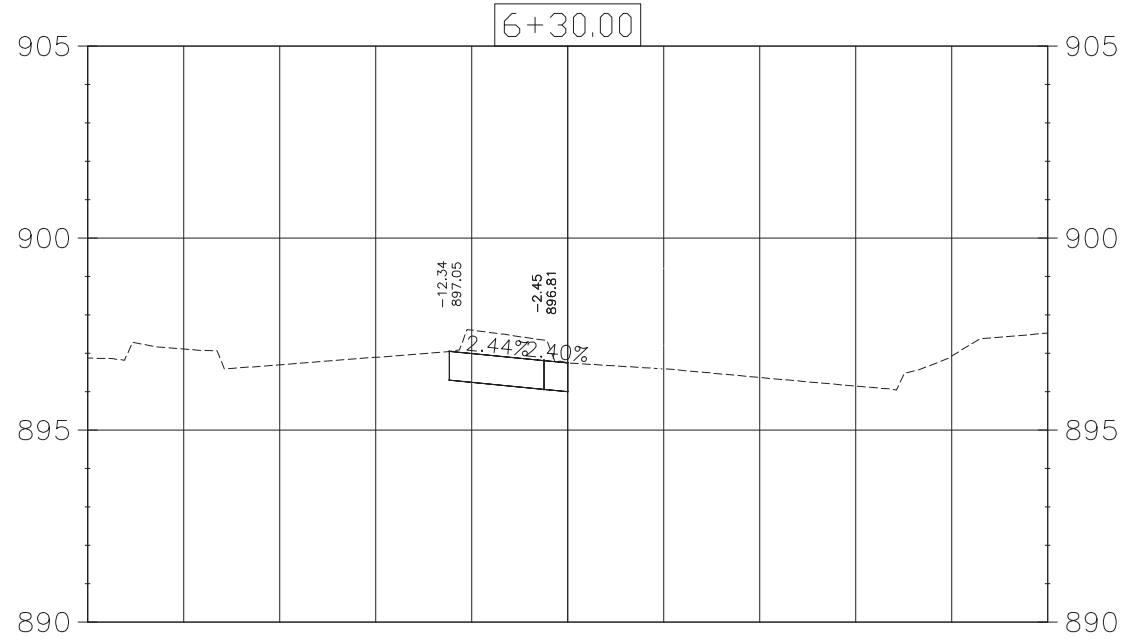
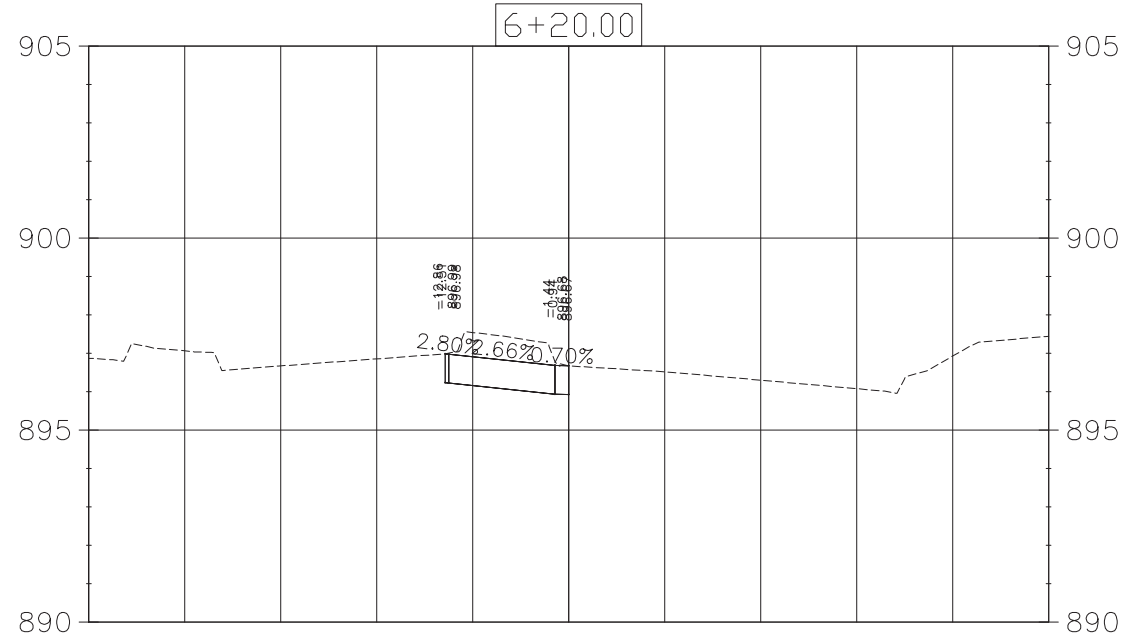
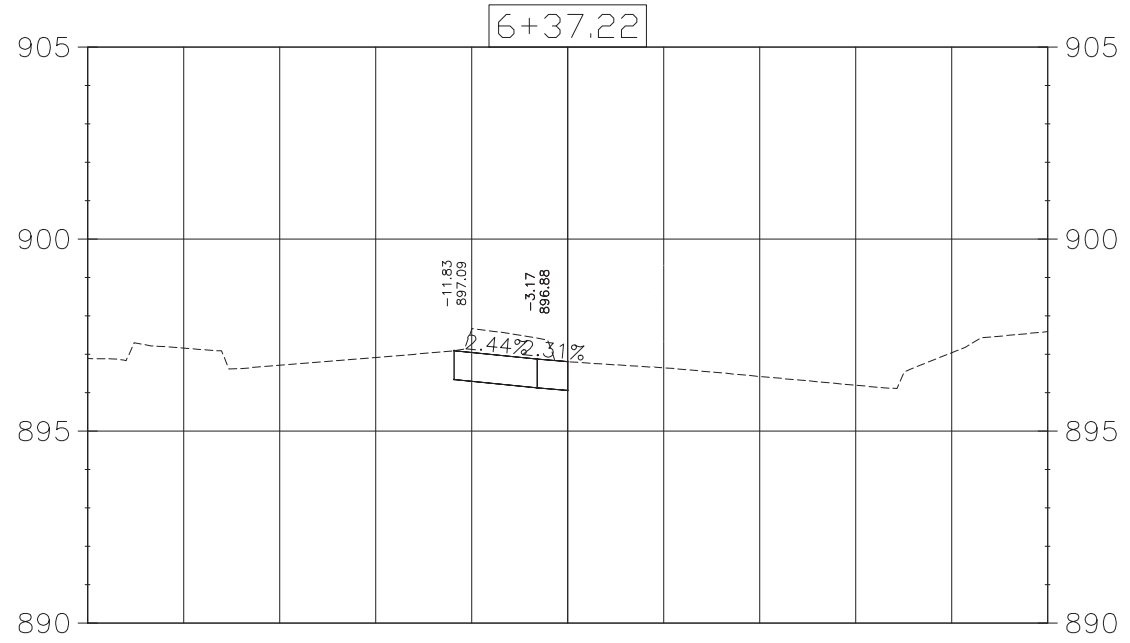
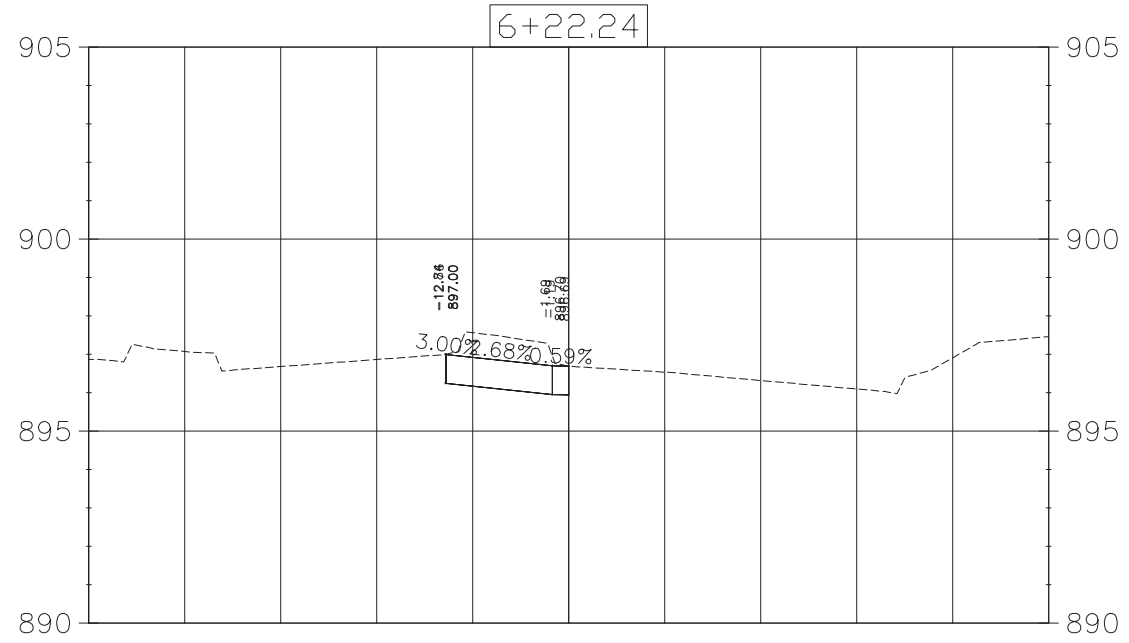

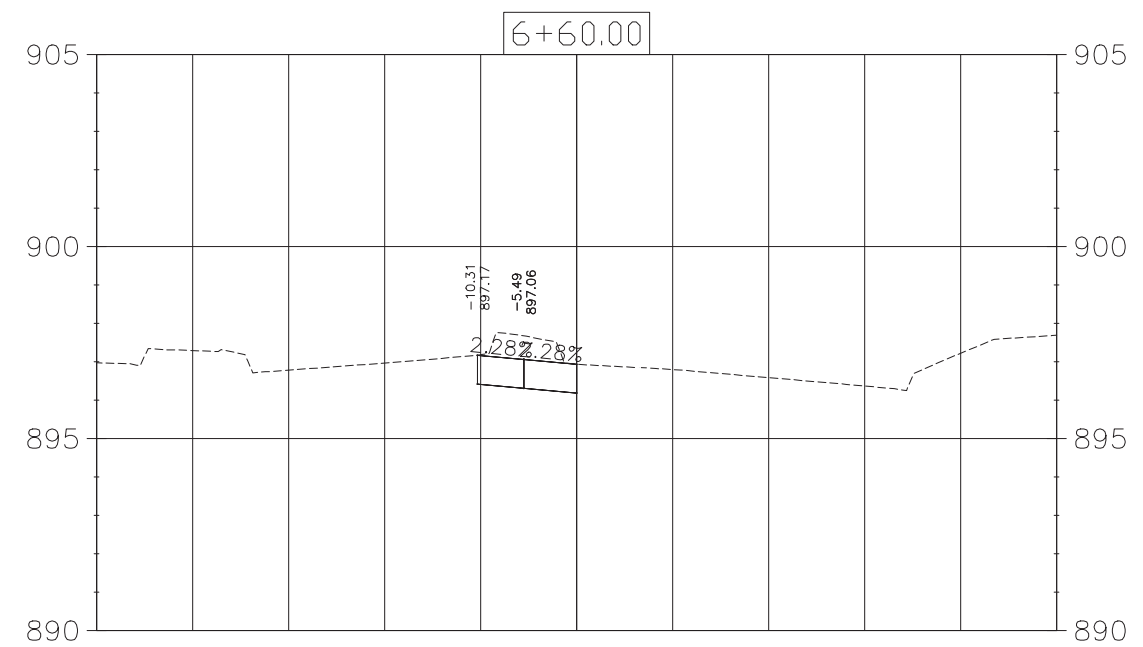
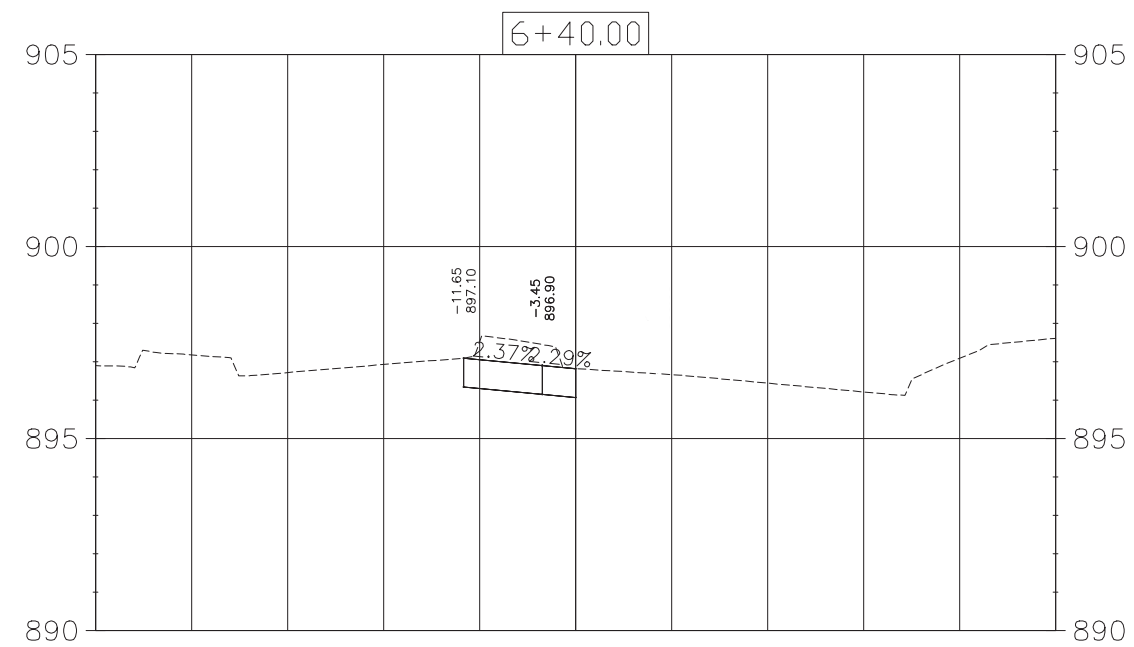
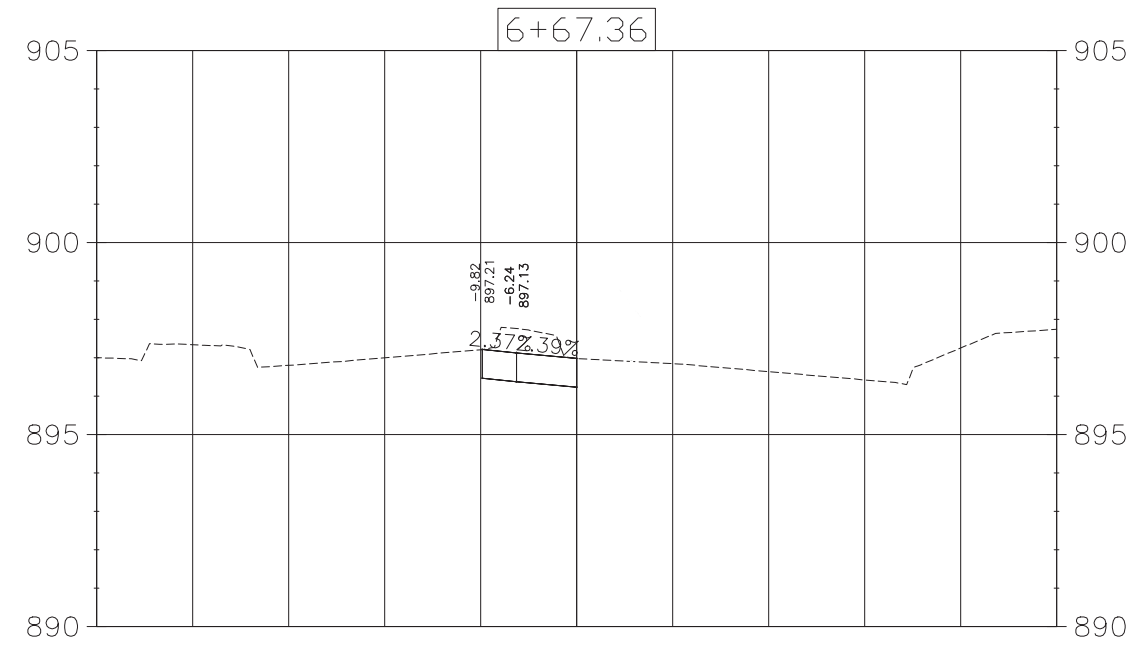
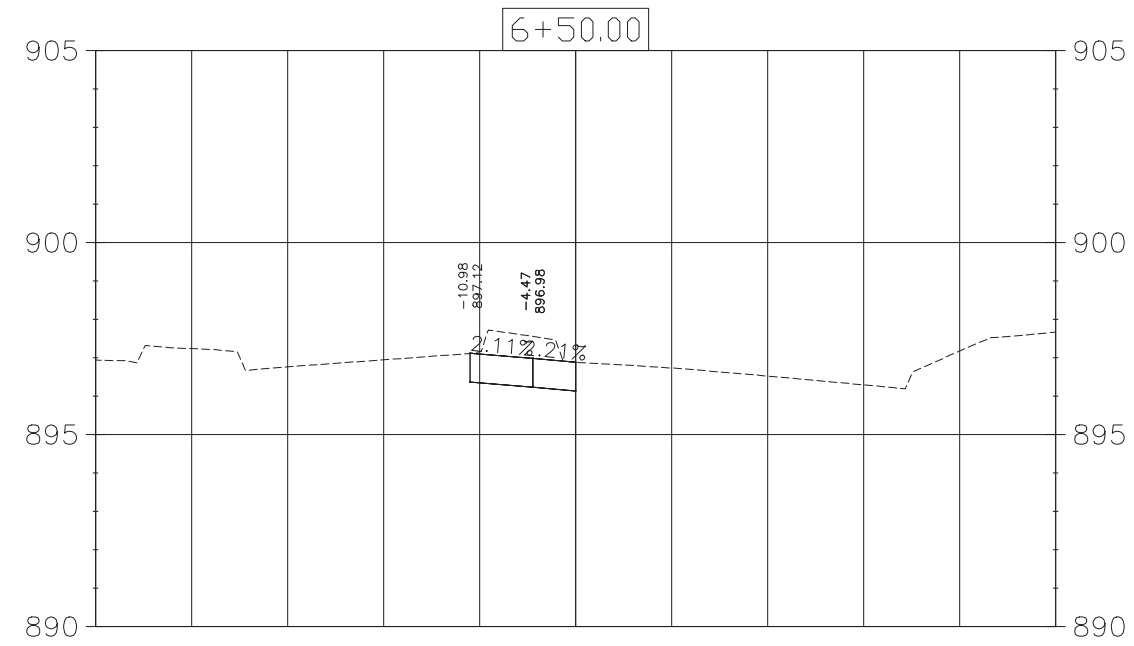

	STATE	PROJECT NO.	SECTION NO.	SHEET NO.
	ND	HEU-8-984(179)	200	15

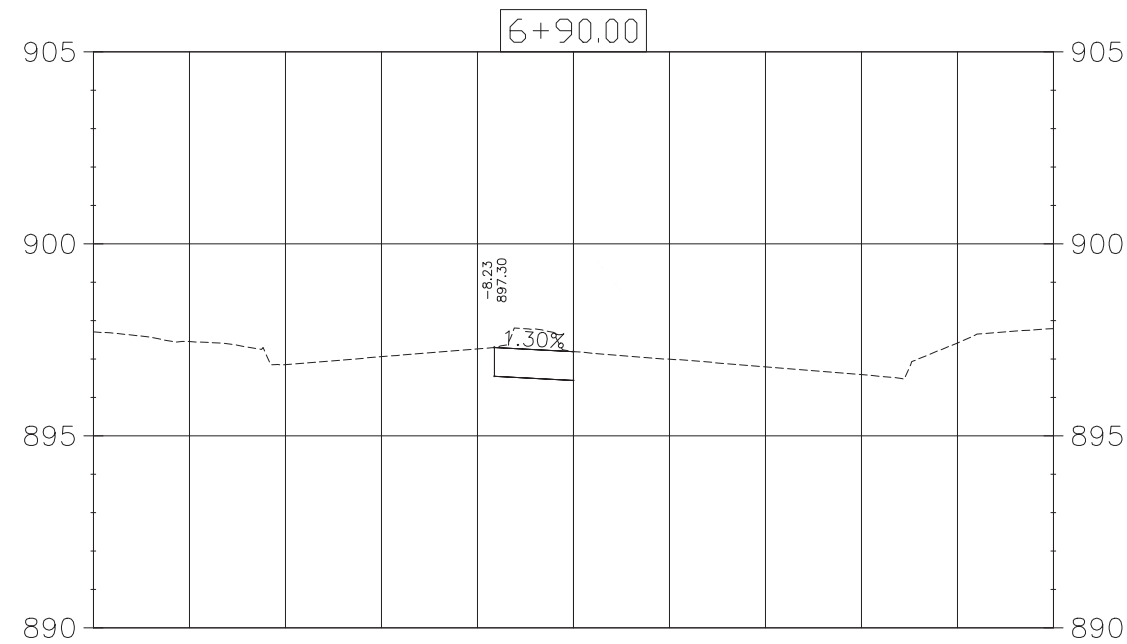
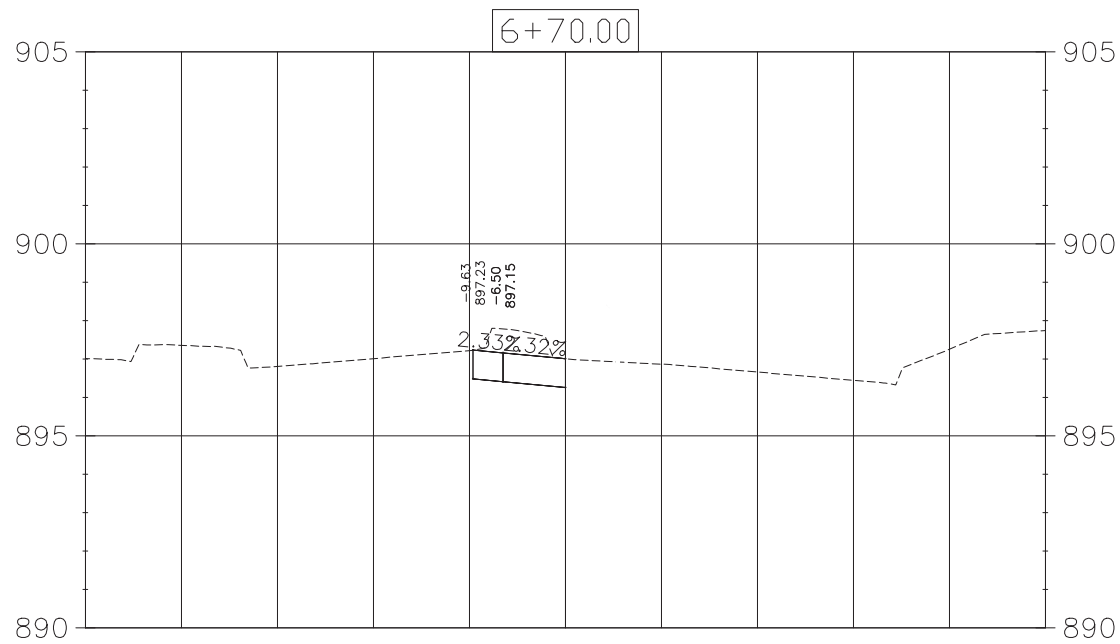
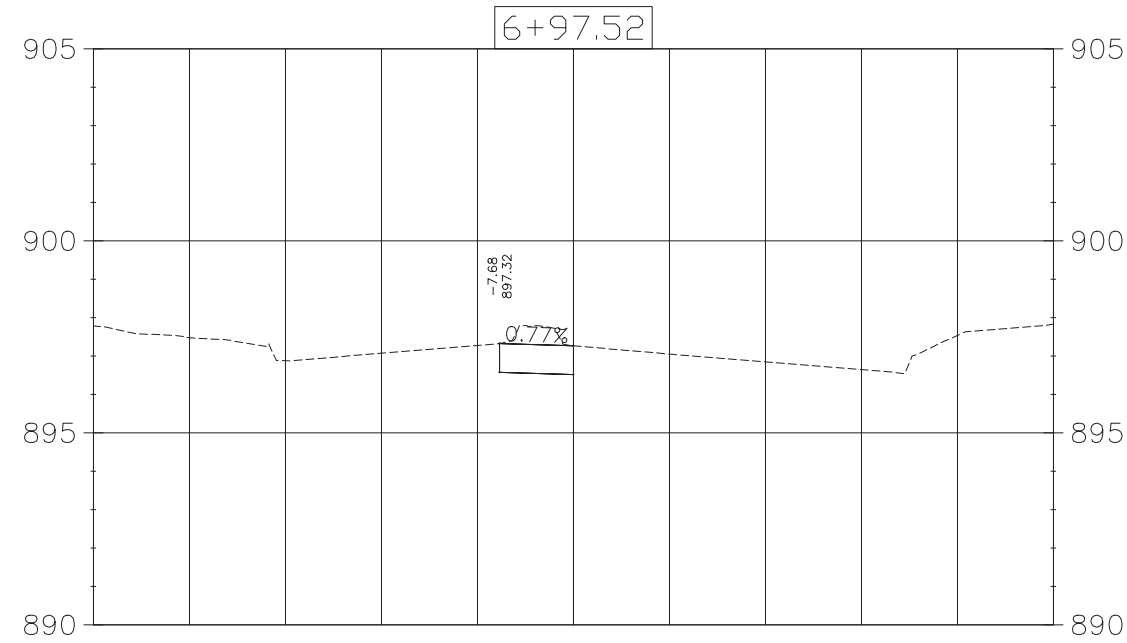
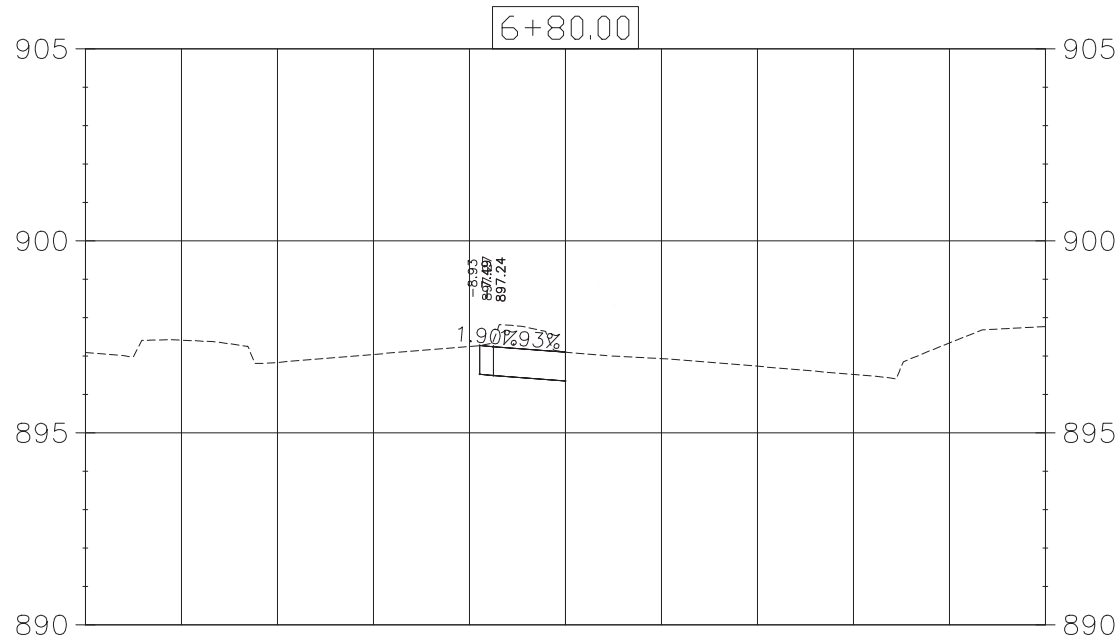

	STATE	PROJECT NO.	SECTION NO.	SHEET NO.
	ND	HEU-8-984(179)	200	16

