

STATE	PROJECT NO.	SECTION NO.	SHEET NO.
ND	SOIB-7-804(061)283	200	6

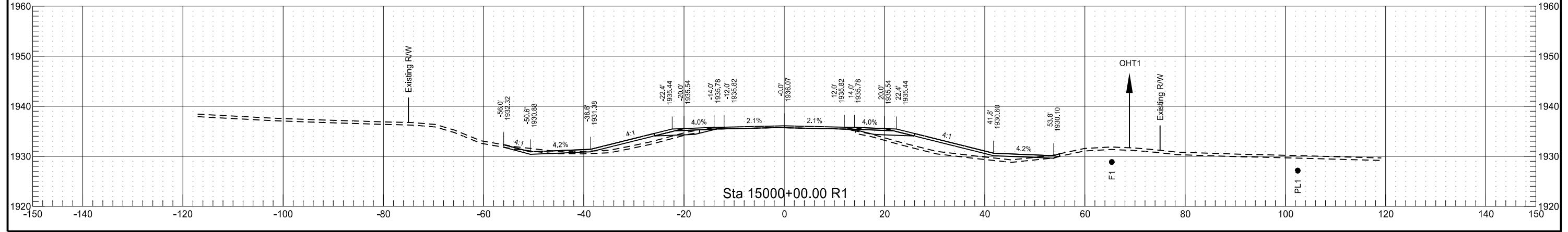

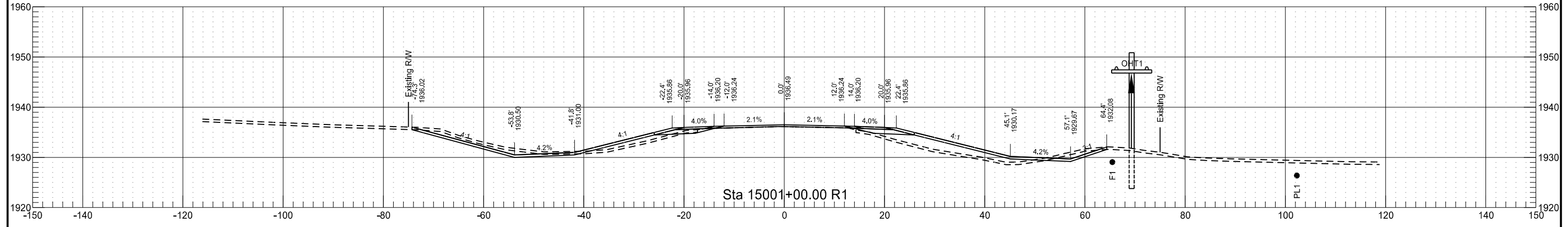

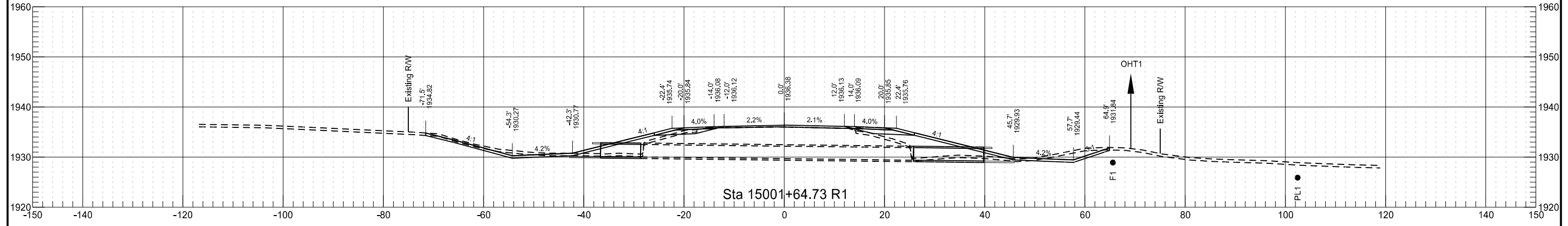

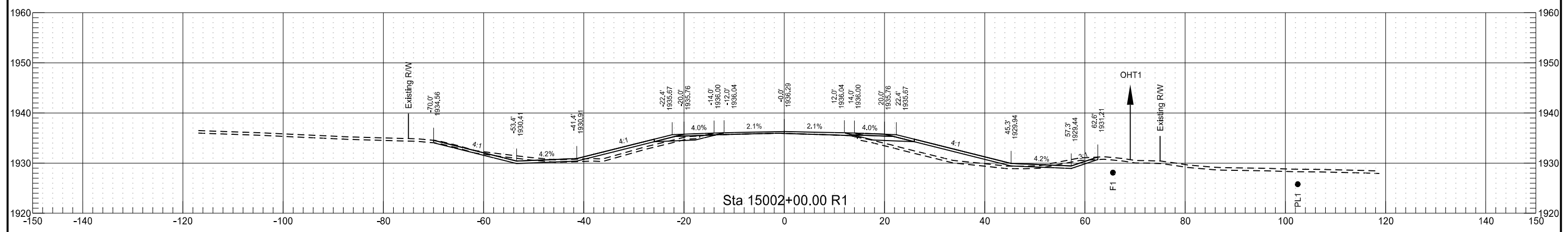
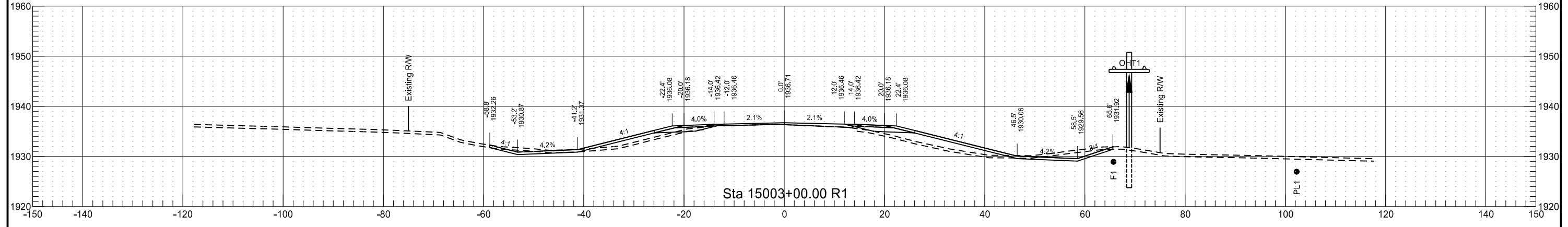
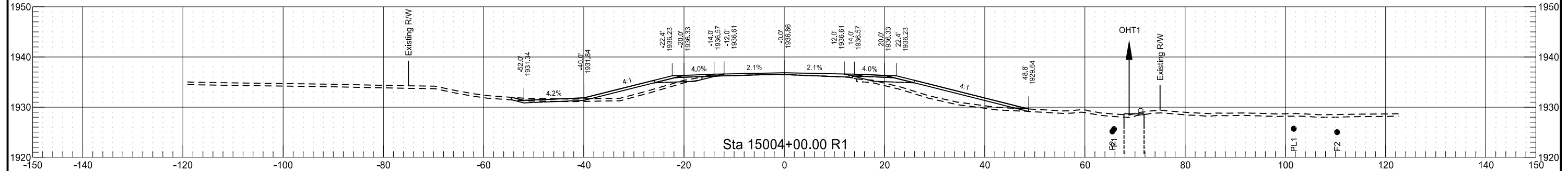
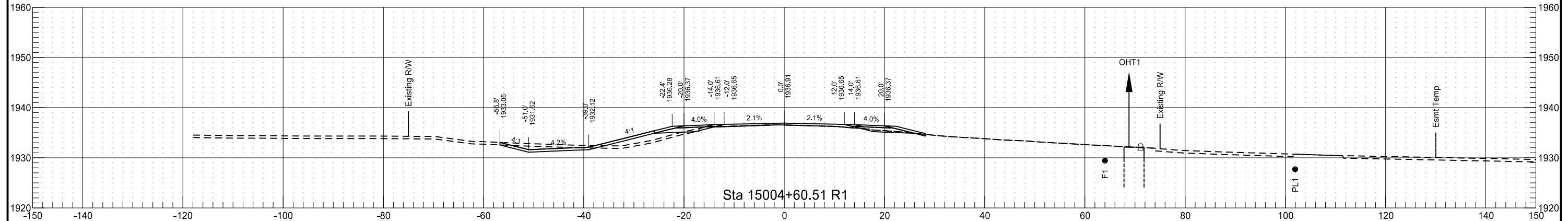
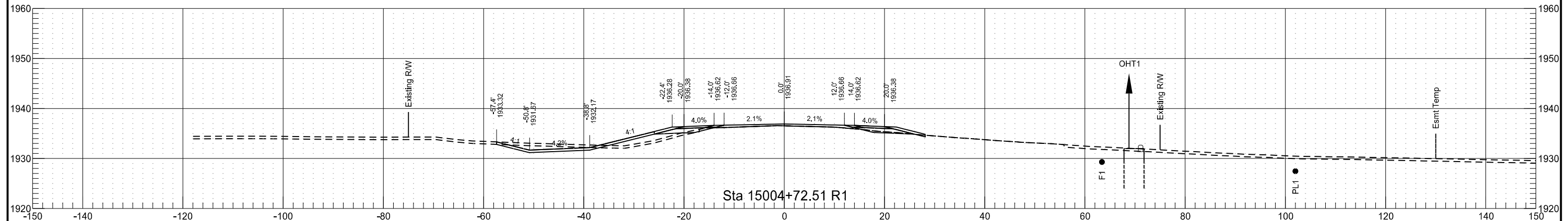
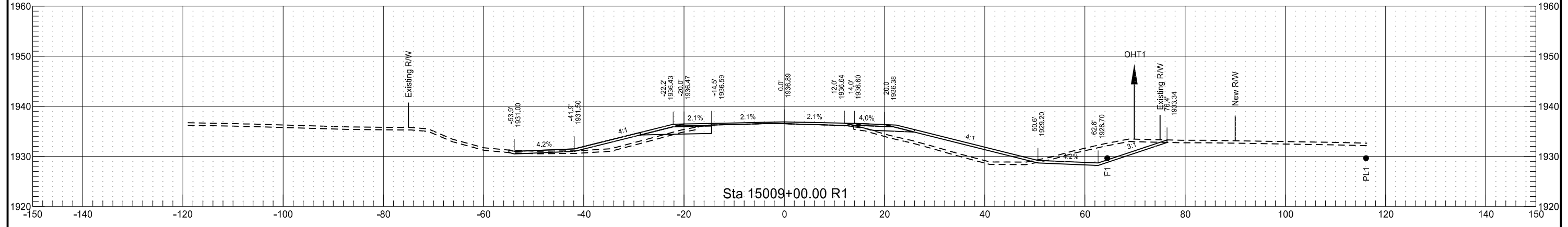
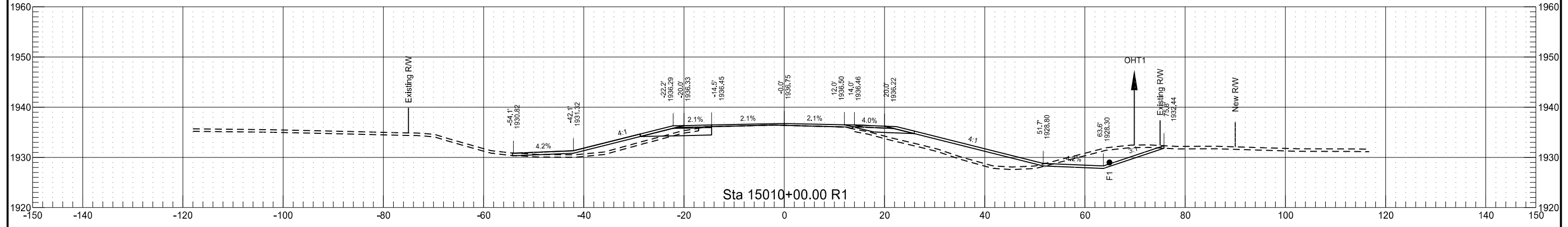
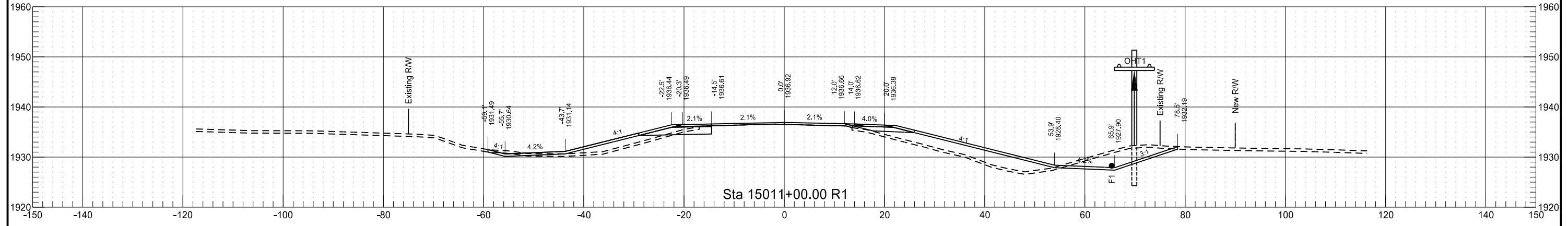
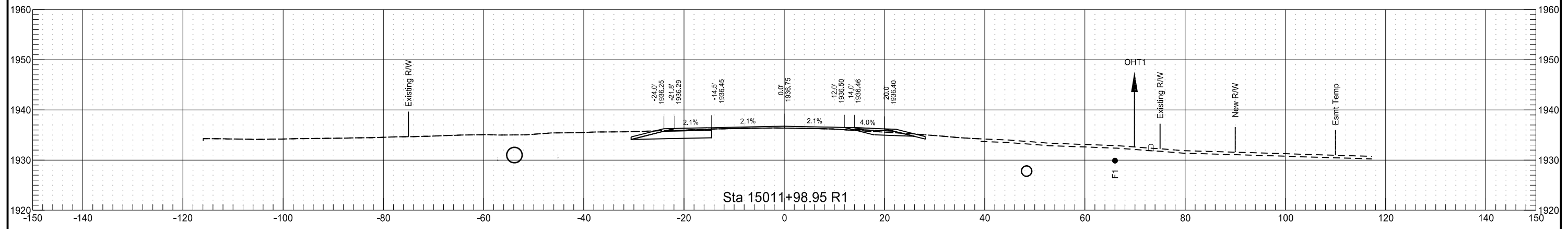
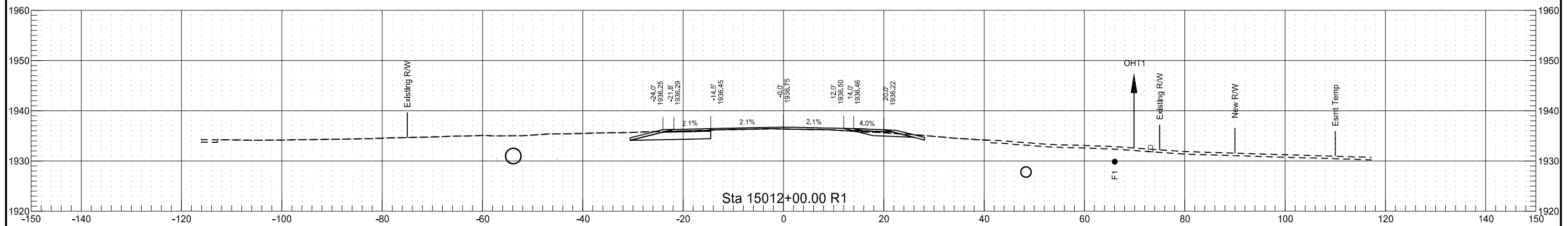
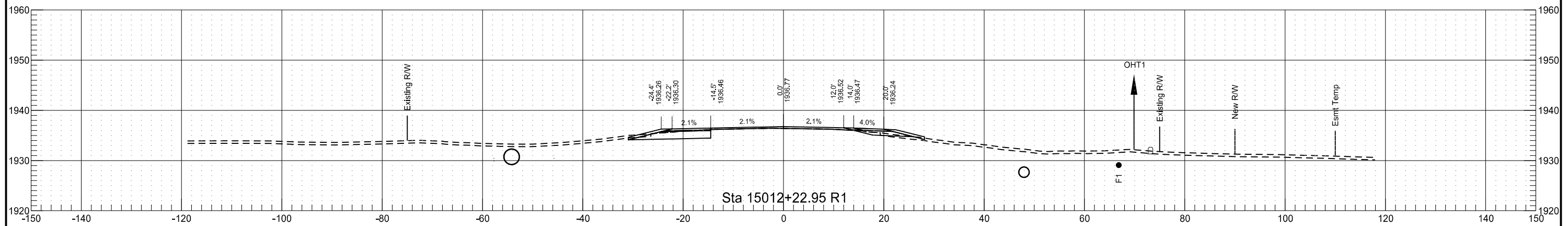
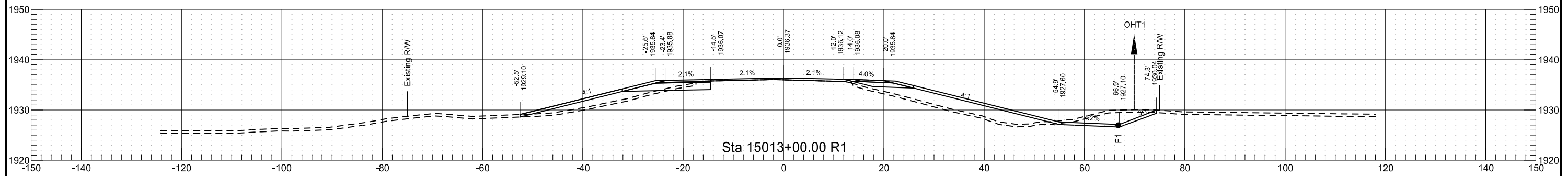
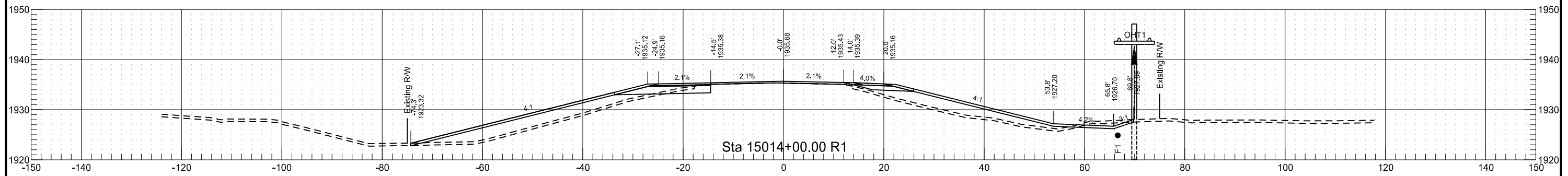

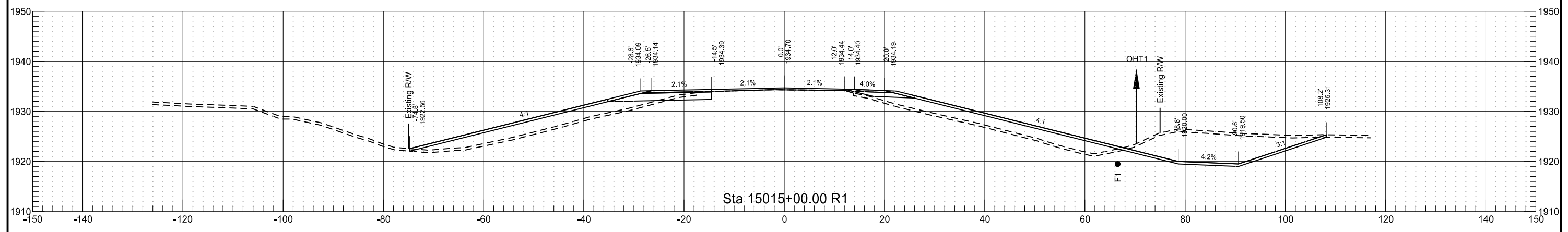
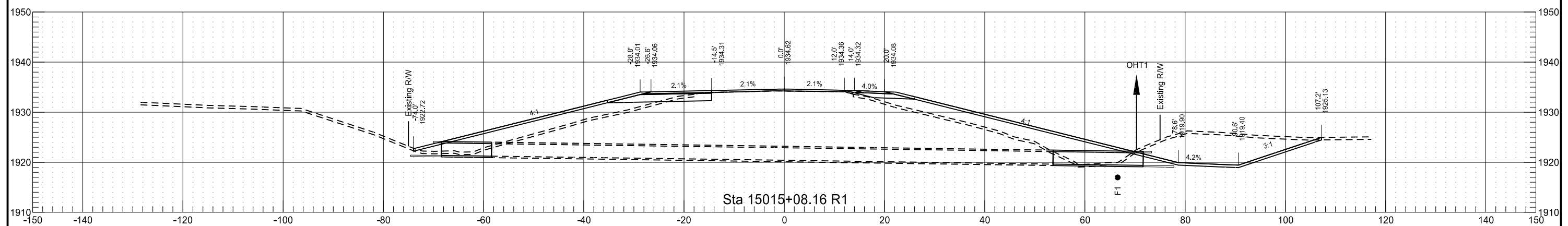
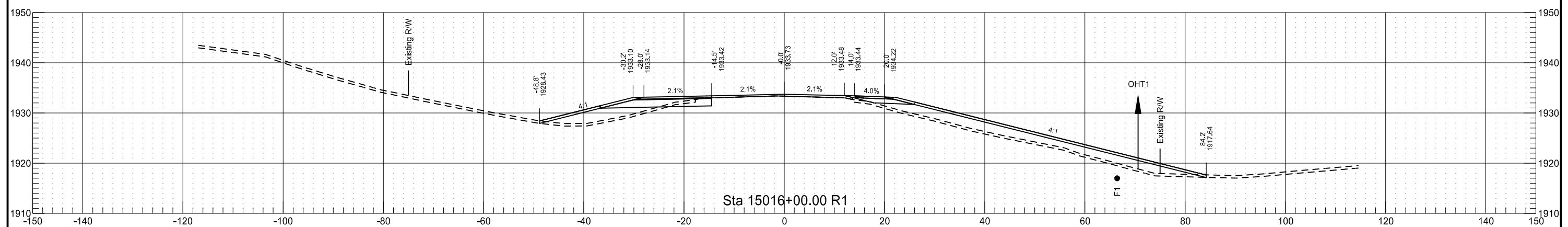

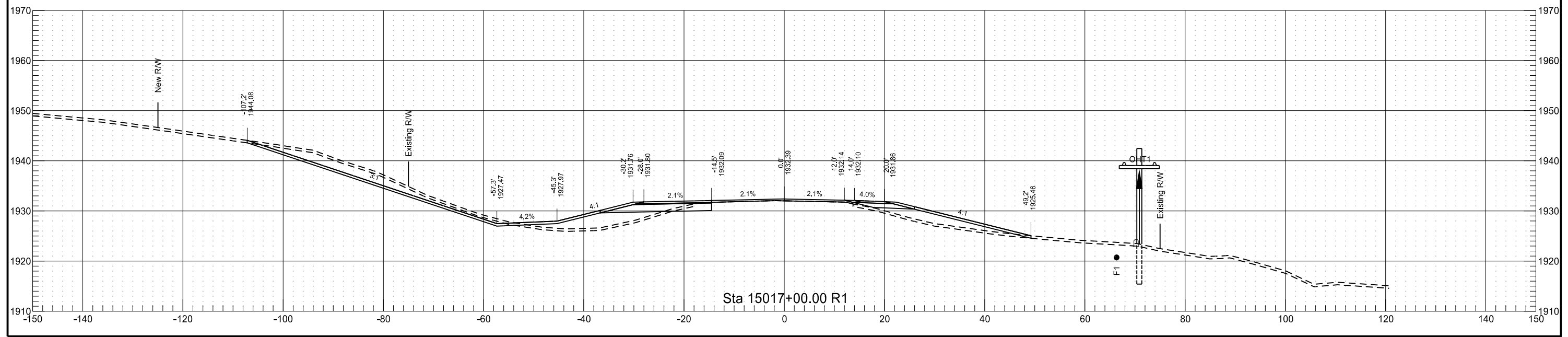
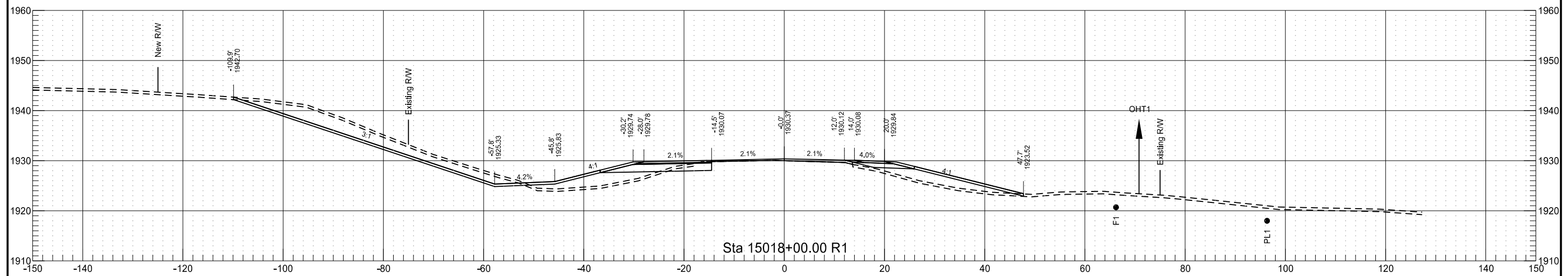
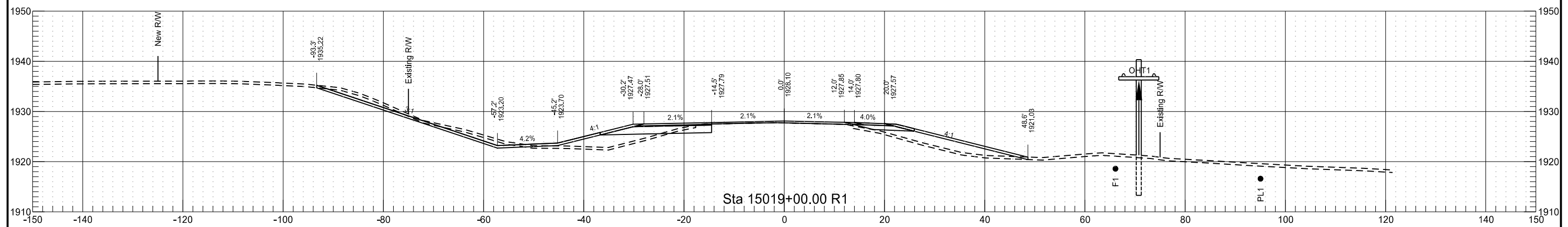

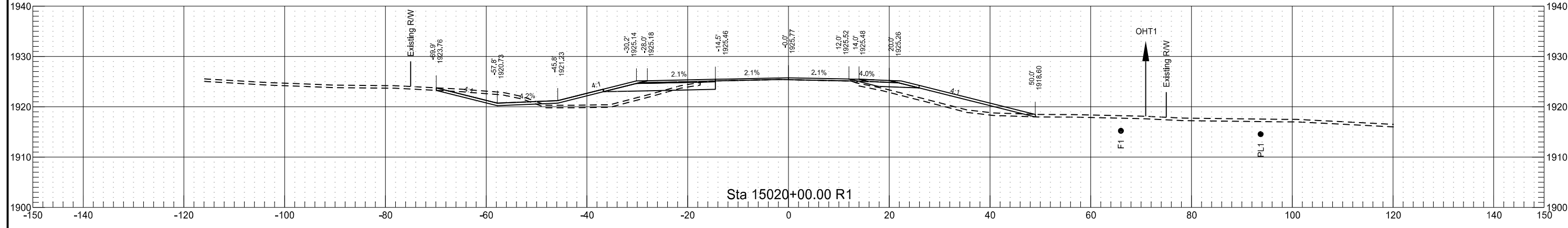
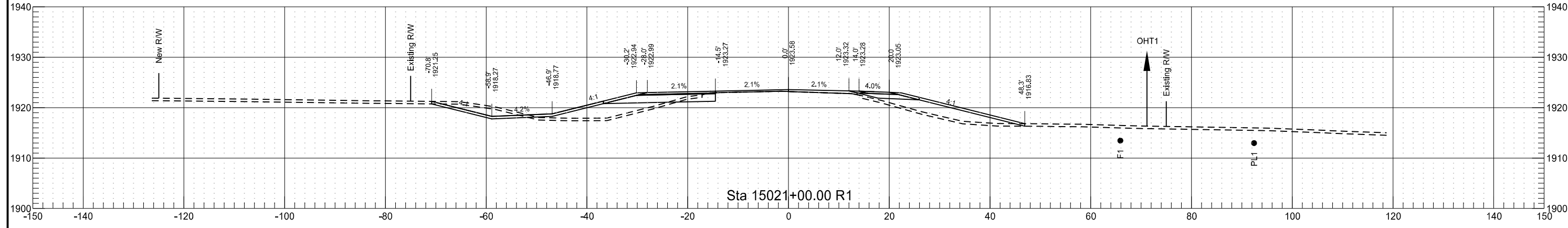
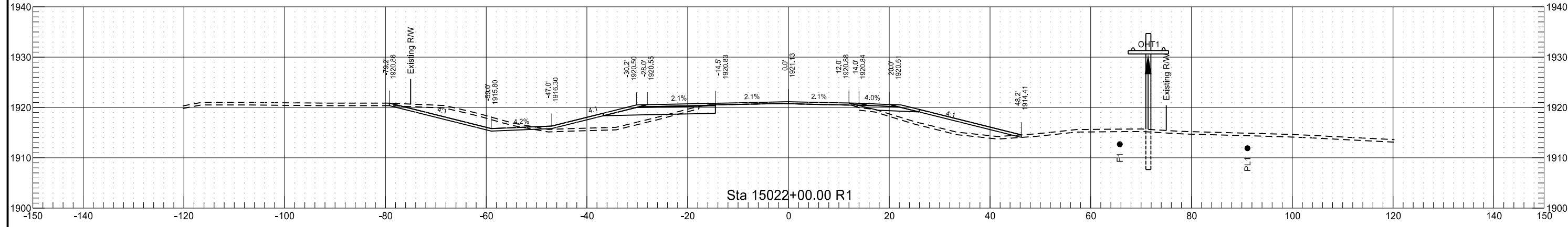
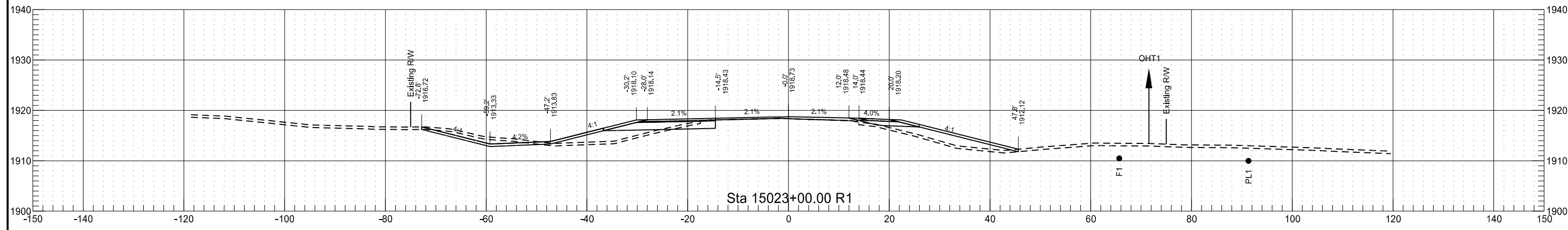

	STATE	PROJECT NO.	SECTION NO.	SHEET NO.
	ND	SOIB-7-804(061)283	200	14

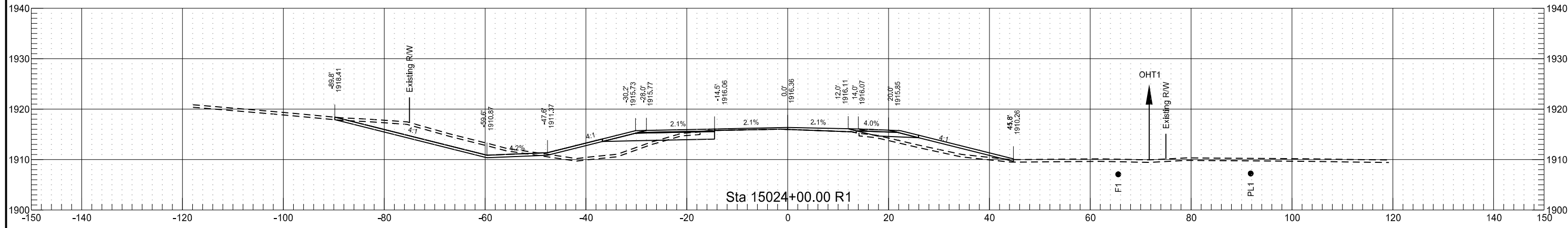
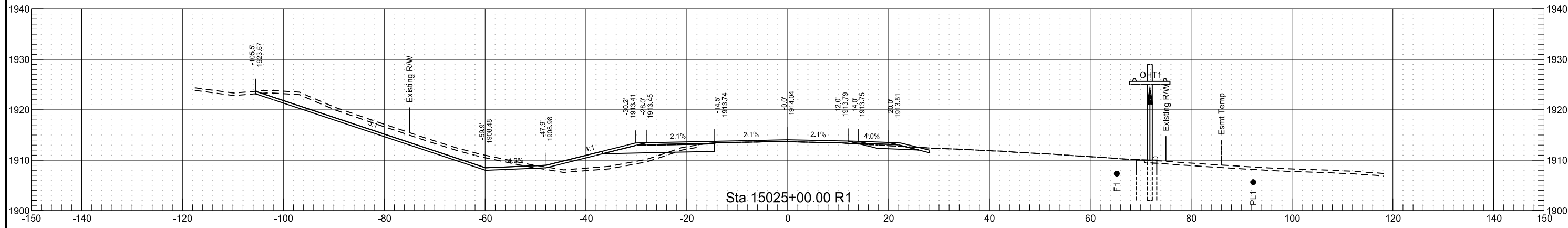
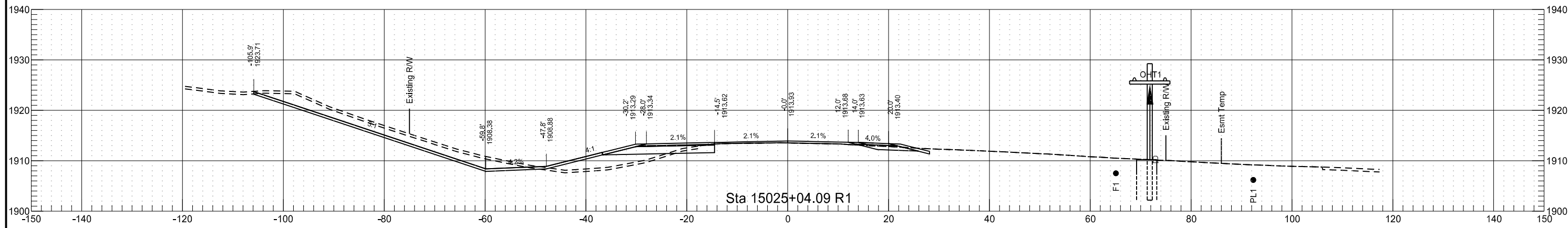
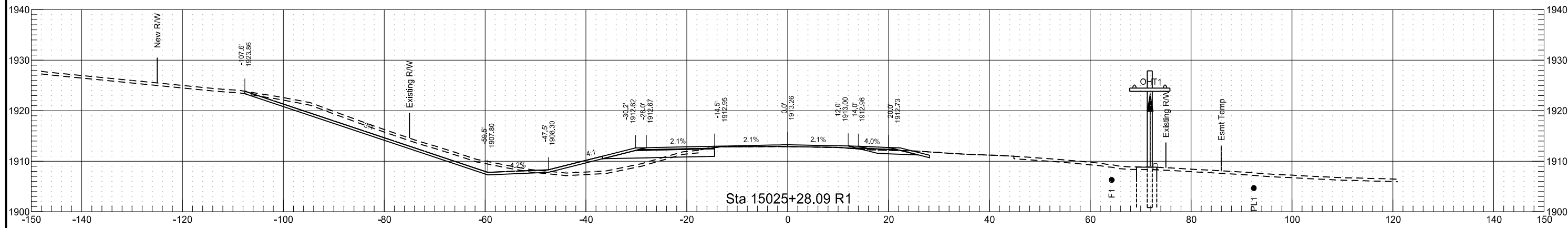

STATE	PROJECT NO.	SECTION NO.	SHEET NO.
ND	SOIB-7-804(061)283	200	15

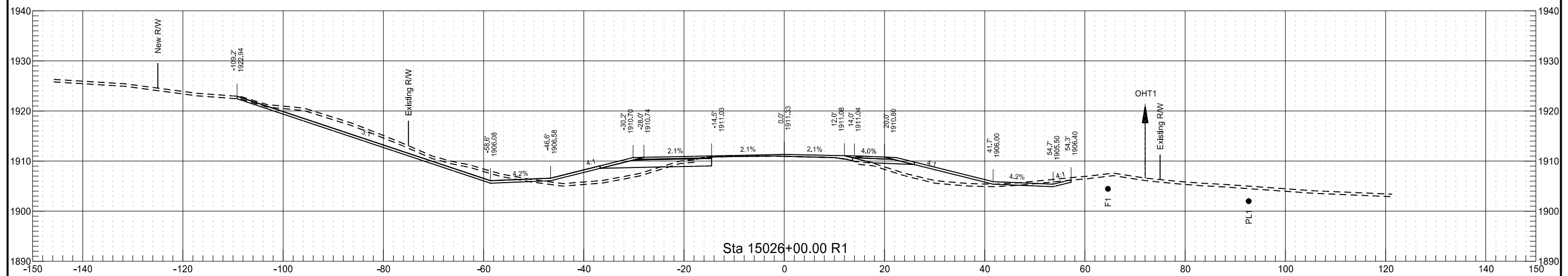
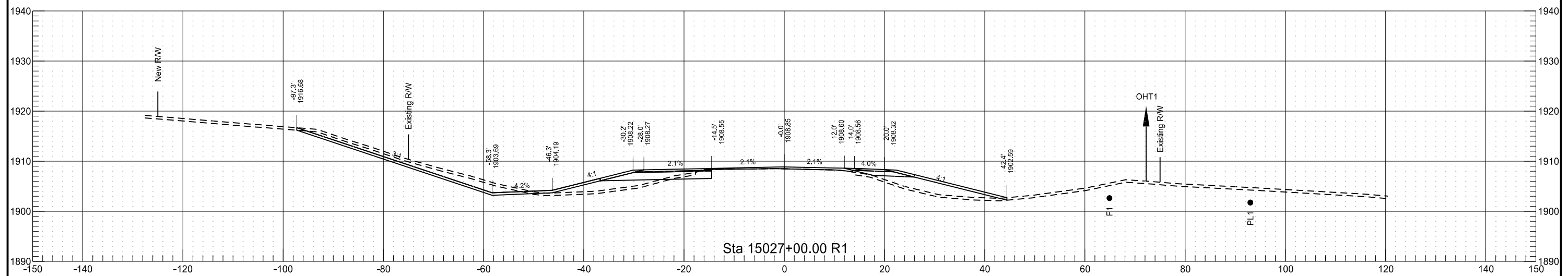
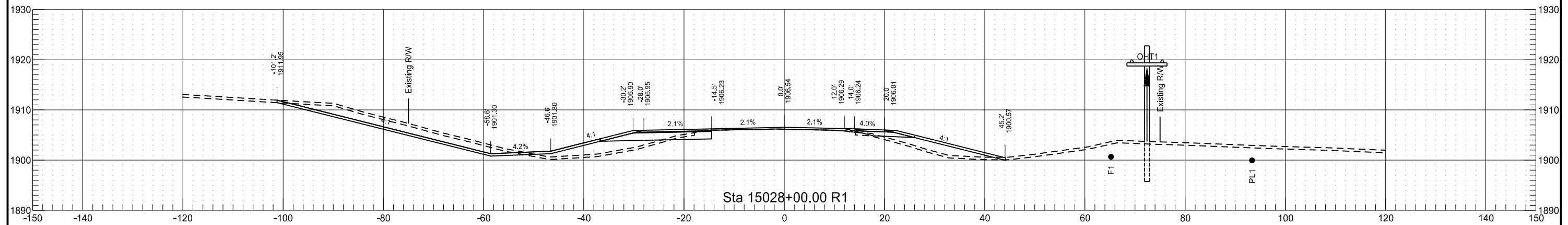

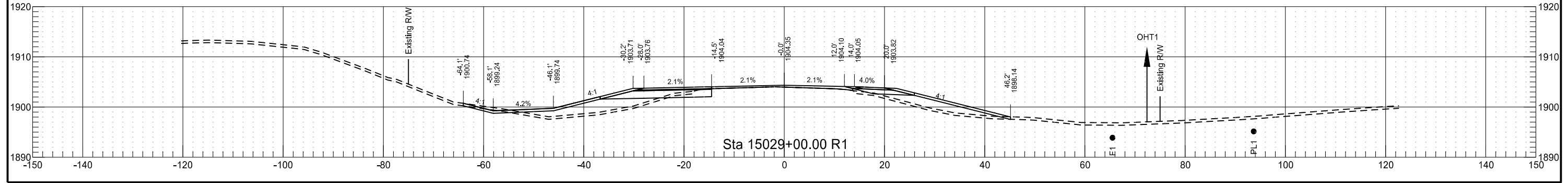
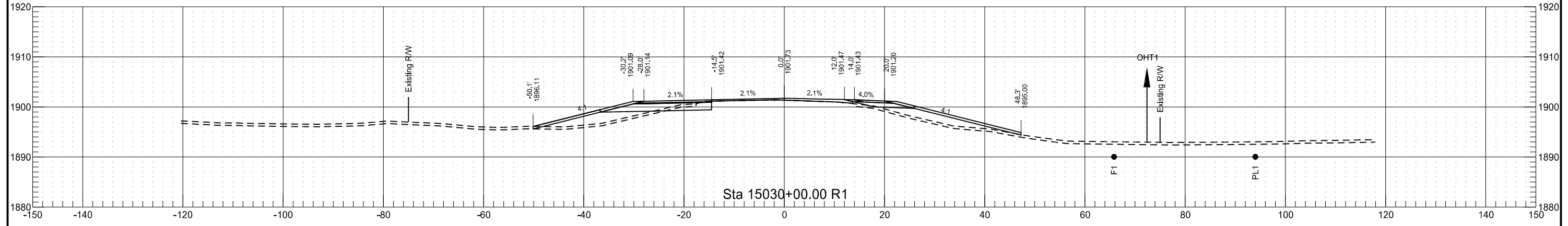
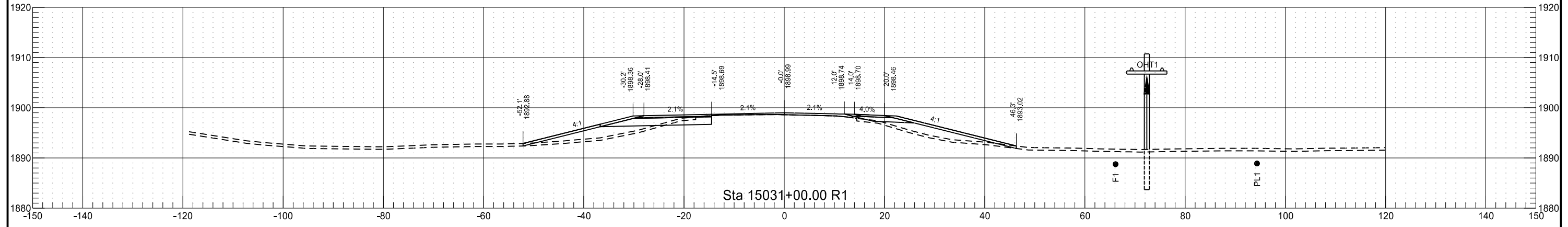
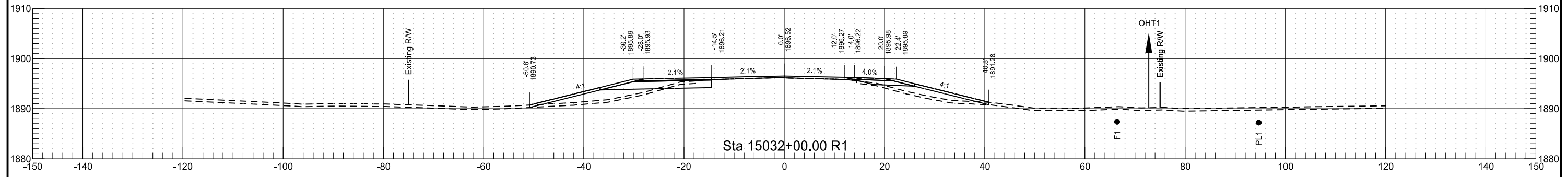

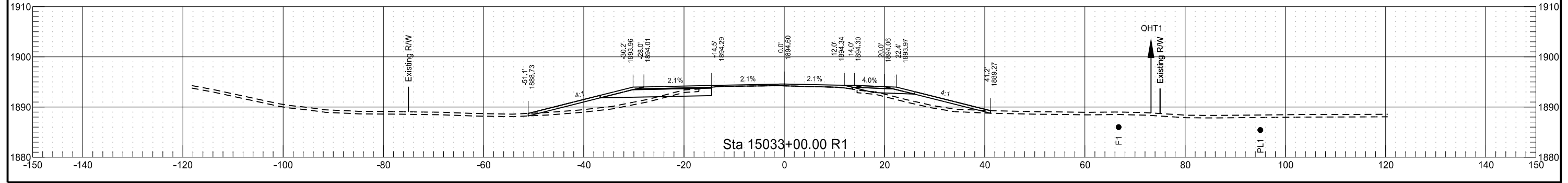
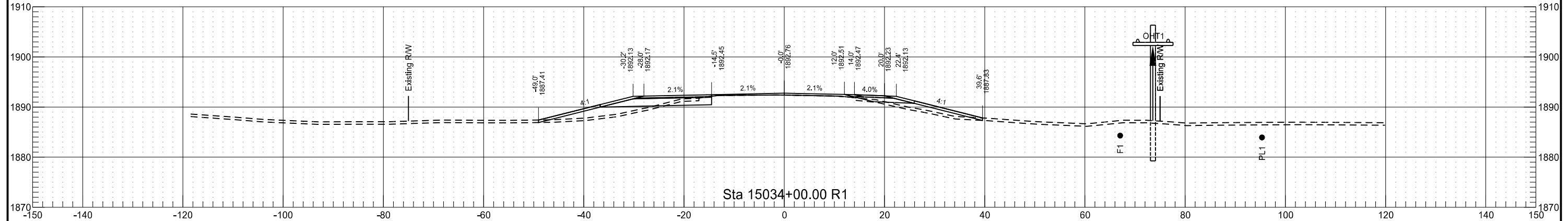
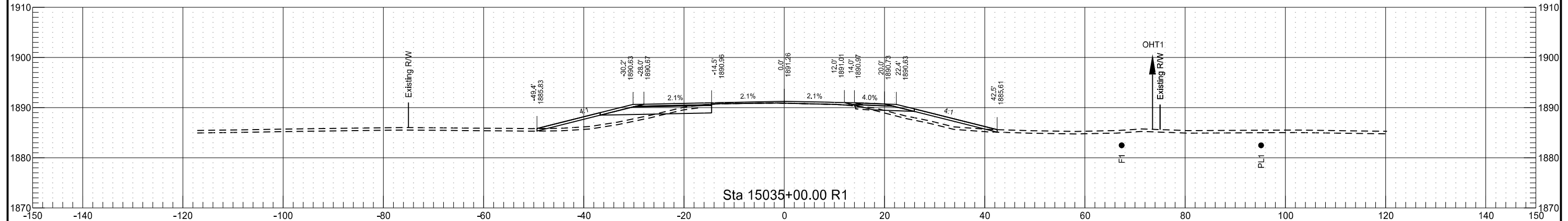
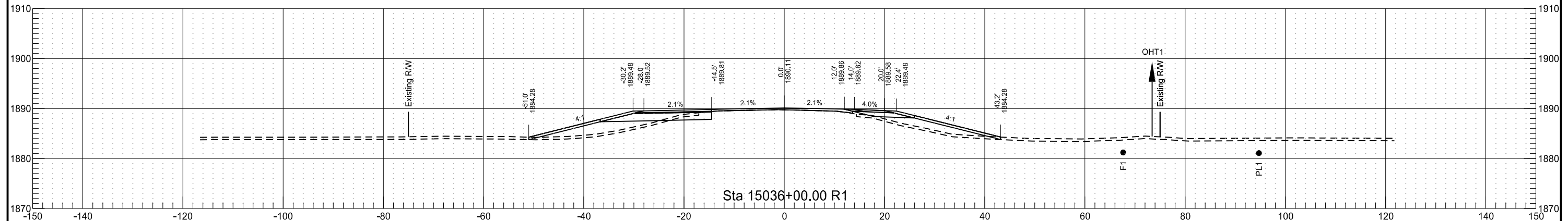

STATE	PROJECT NO.	SECTION NO.	SHEET NO.
ND	SOIB-7-804(061)283	200	18

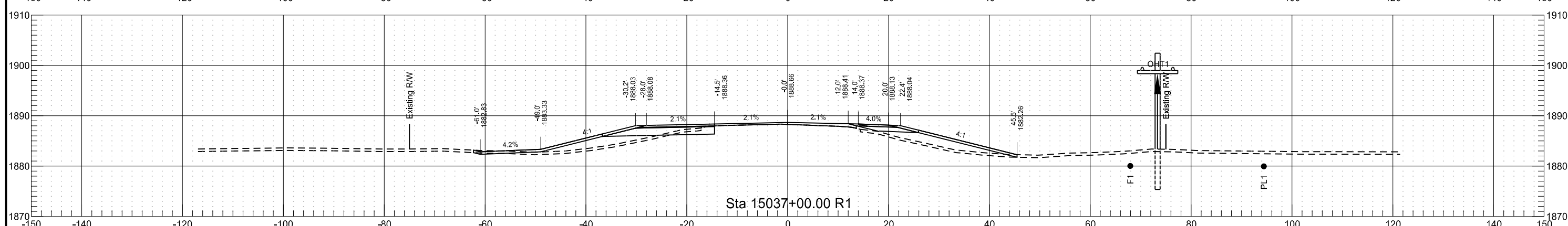
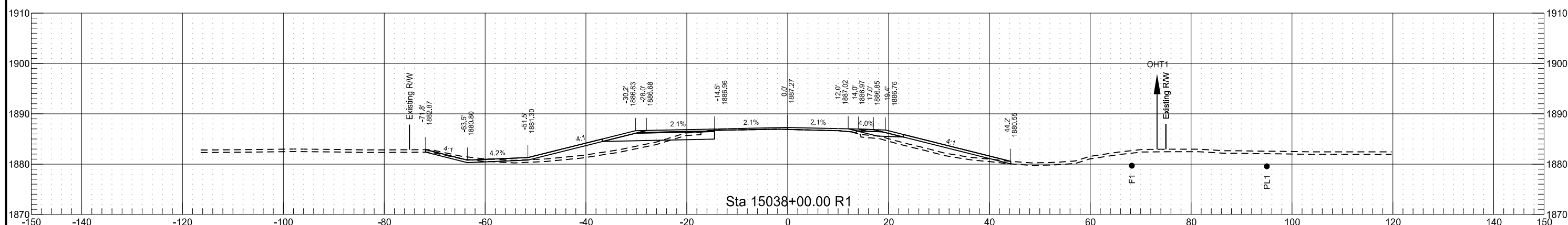
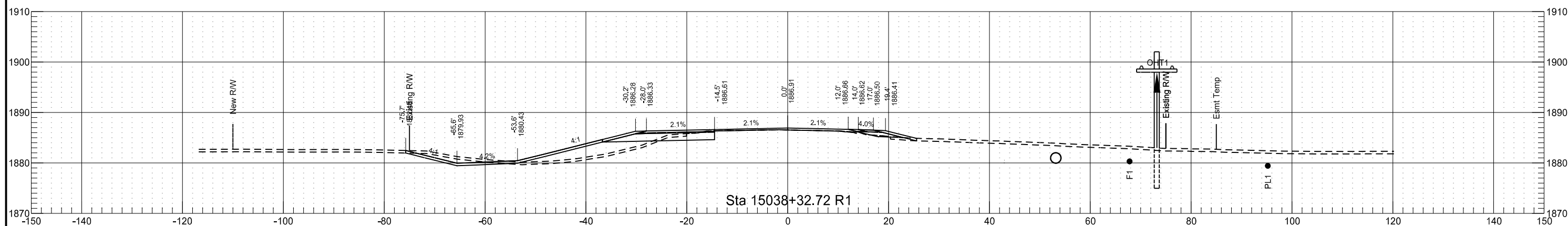
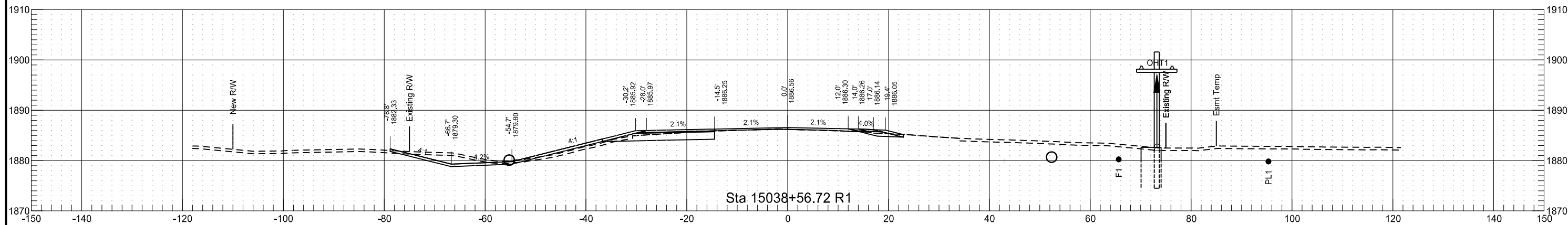

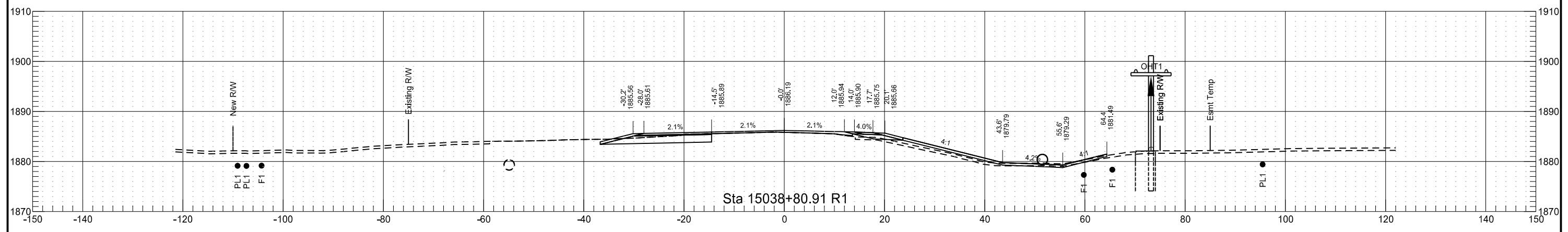
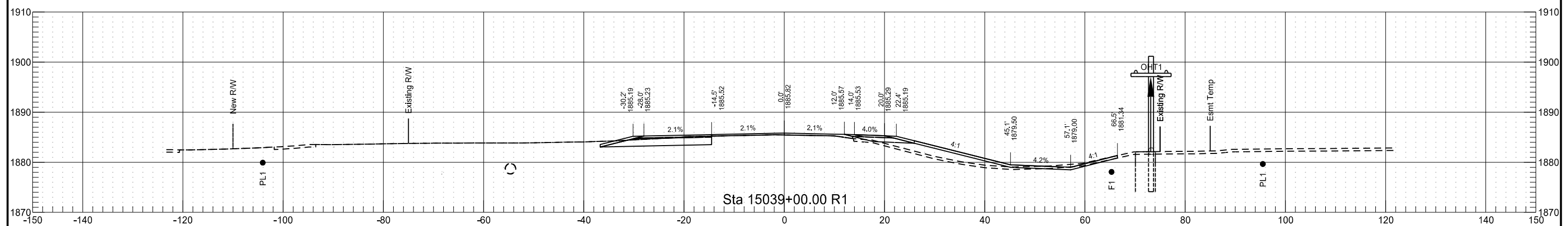
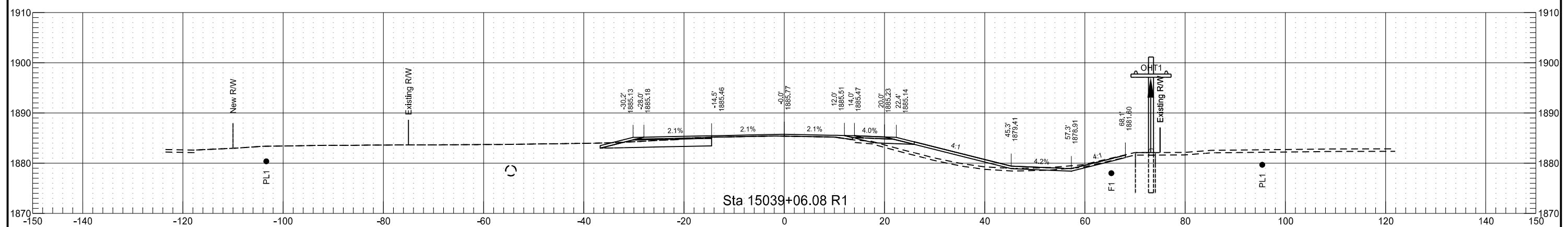

STATE	PROJECT NO.	SECTION NO.	SHEET NO.
ND	SOIB-7-804(061)283	200	20

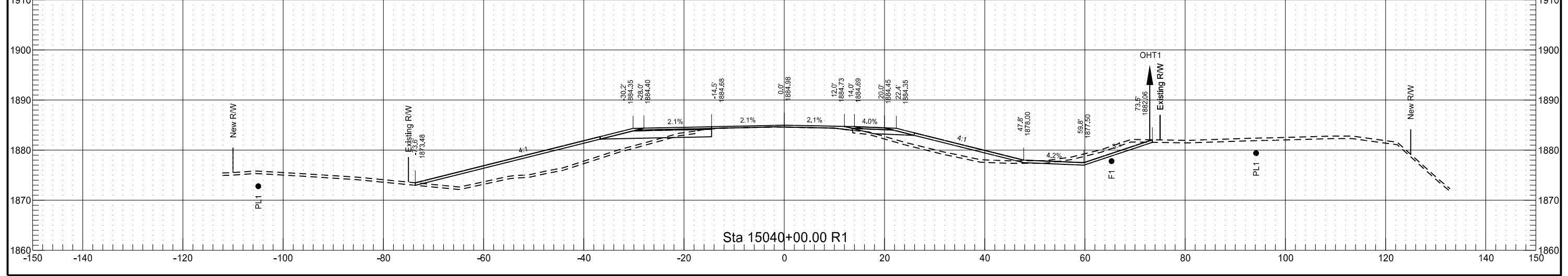
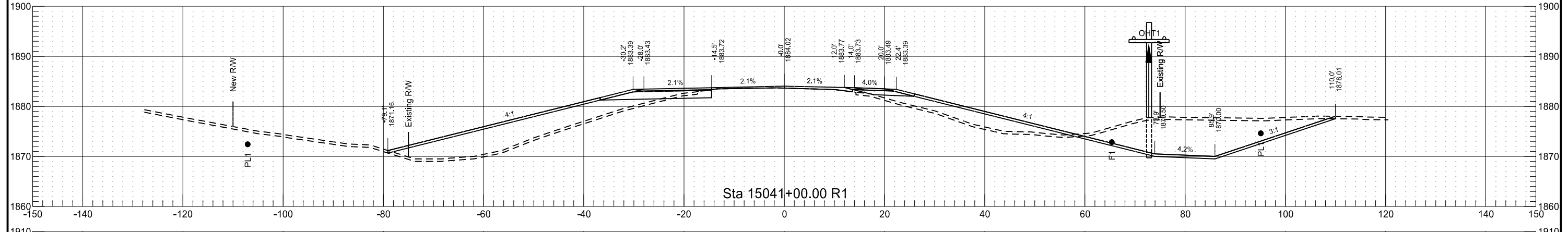
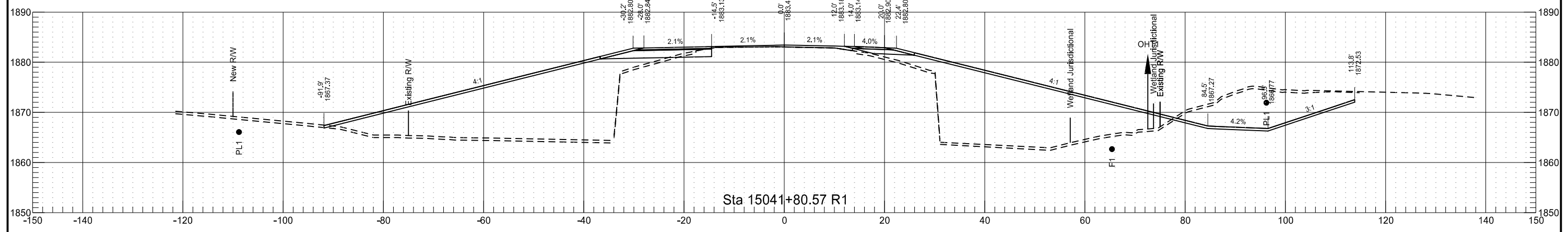

STATE	PROJECT NO.	SECTION NO.	SHEET NO.
ND	SOIB-7-804(061)283	200	21

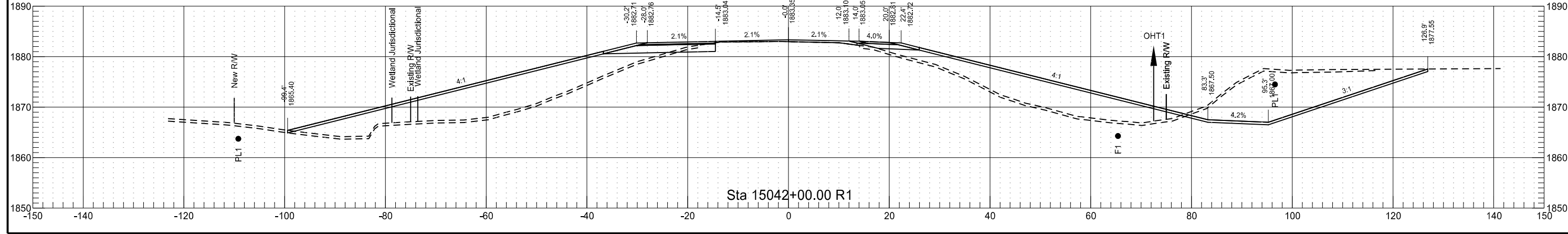
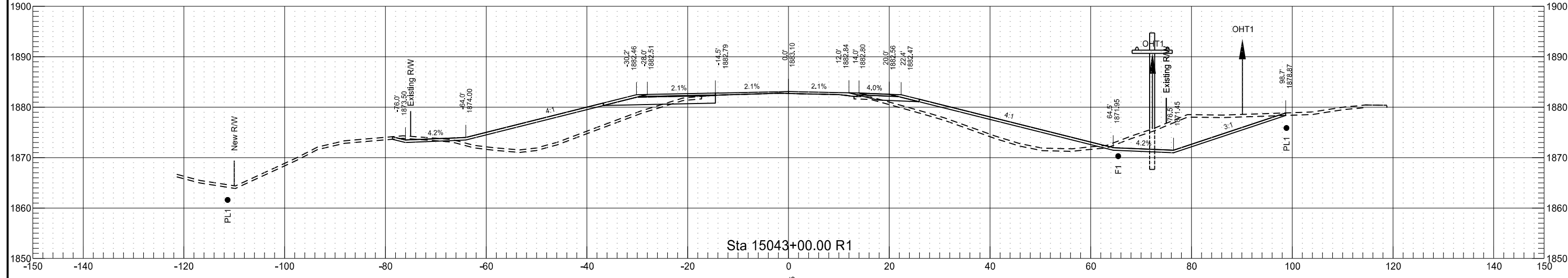
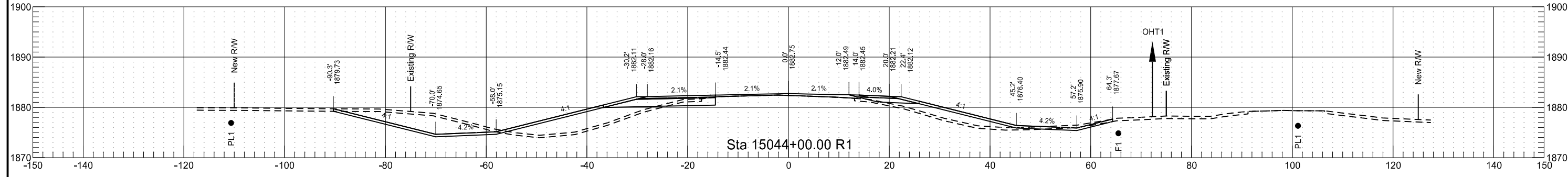
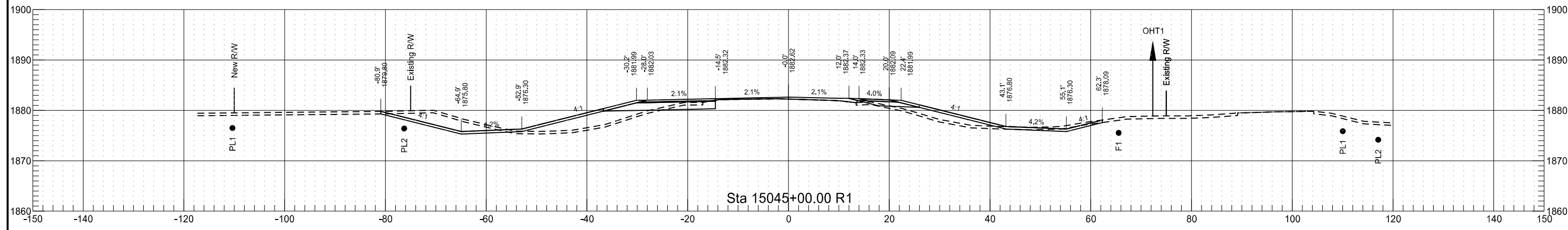

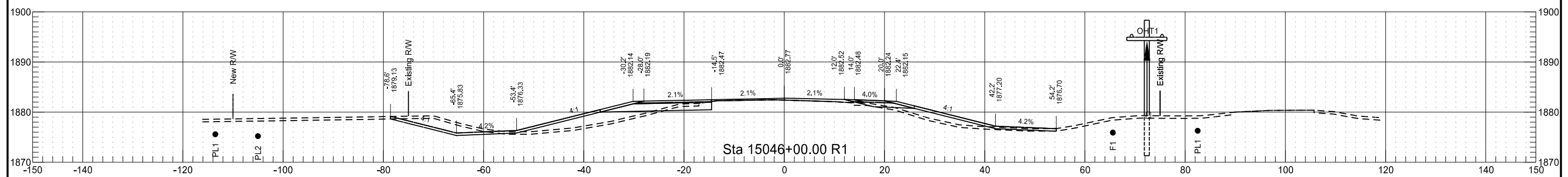
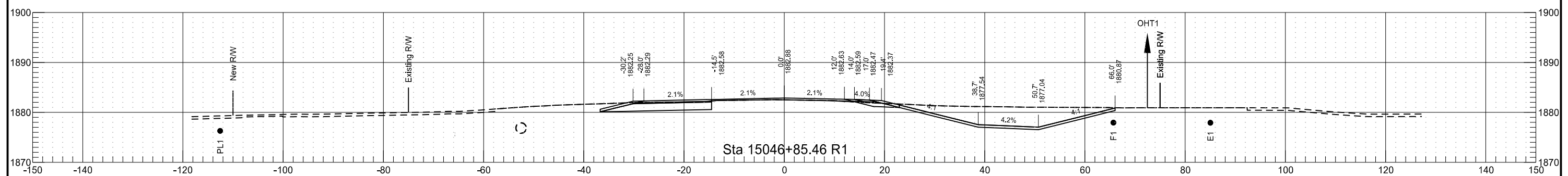
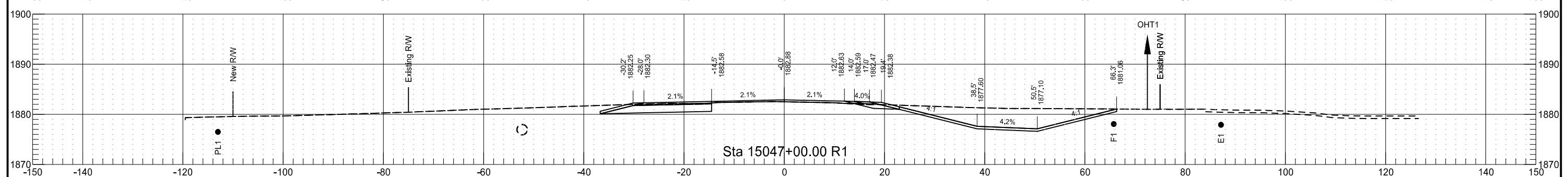
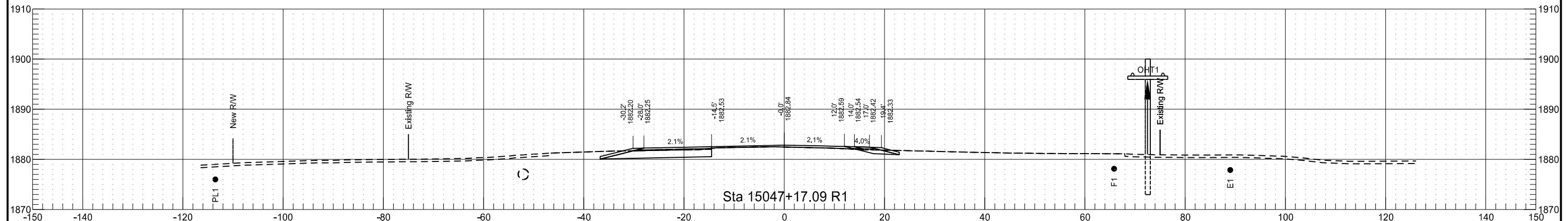
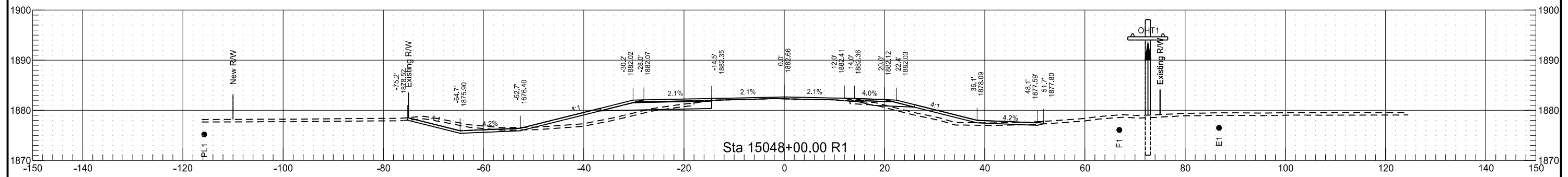

STATE	PROJECT NO.	SECTION NO.	SHEET NO.
ND	SOIB-7-804(061)283	200	24

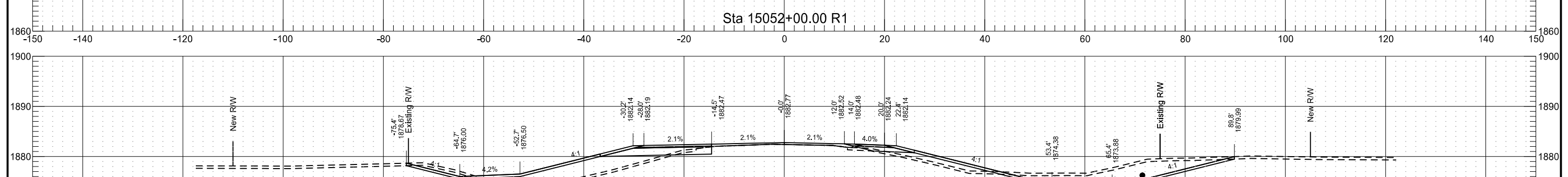
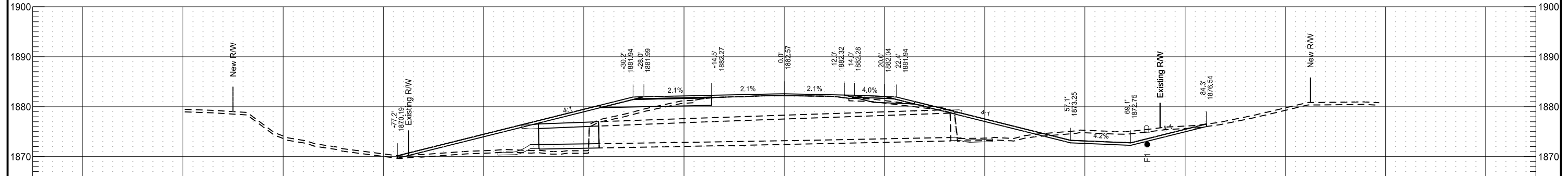
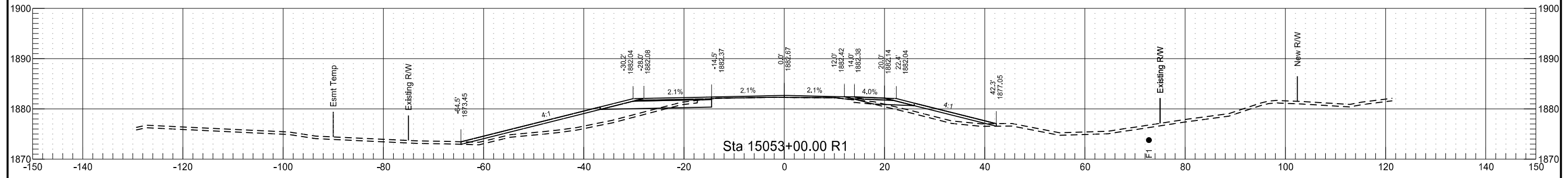
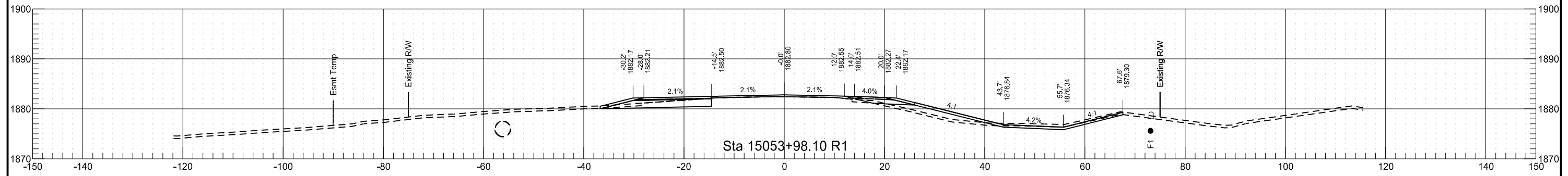
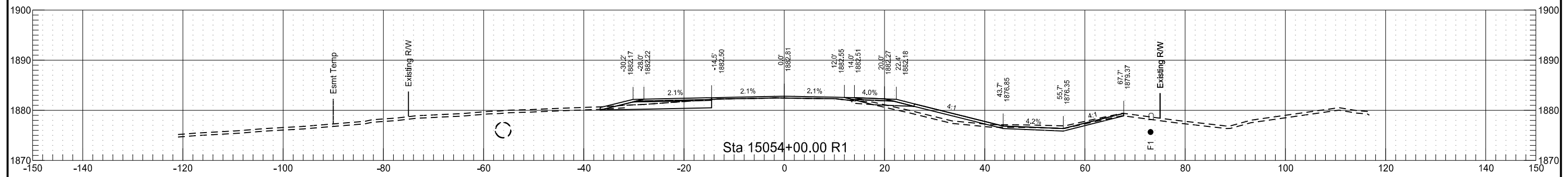

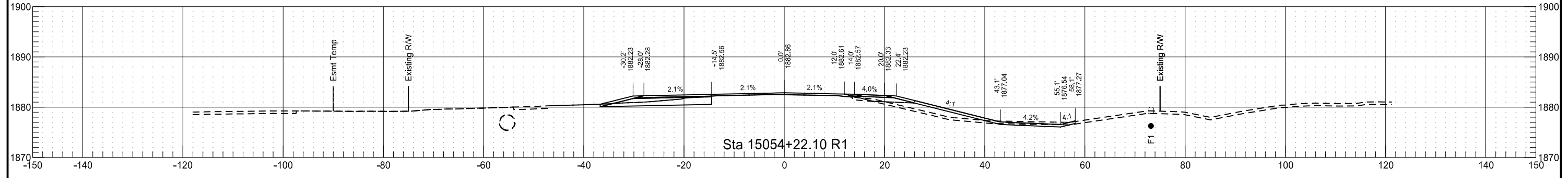
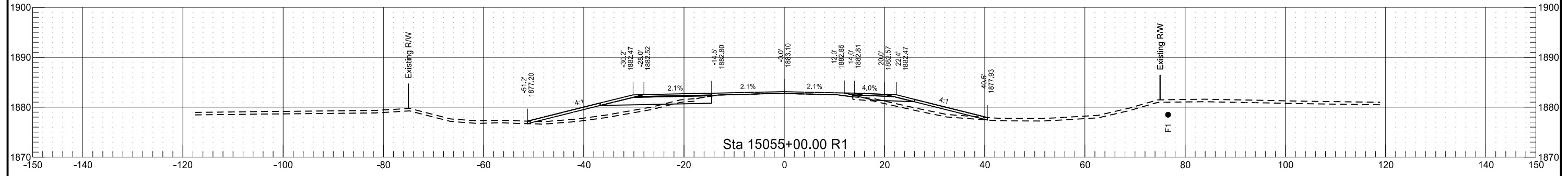
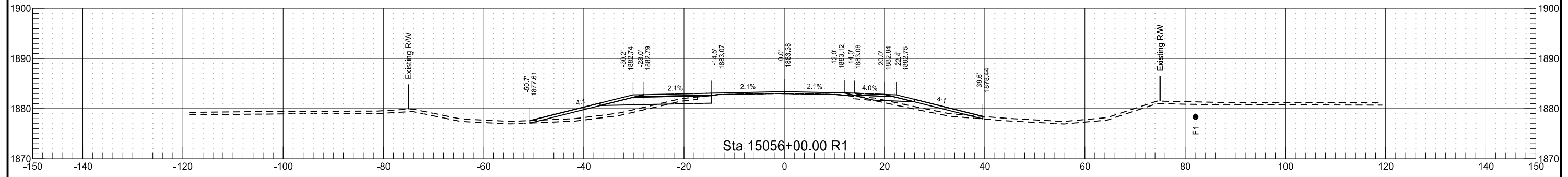
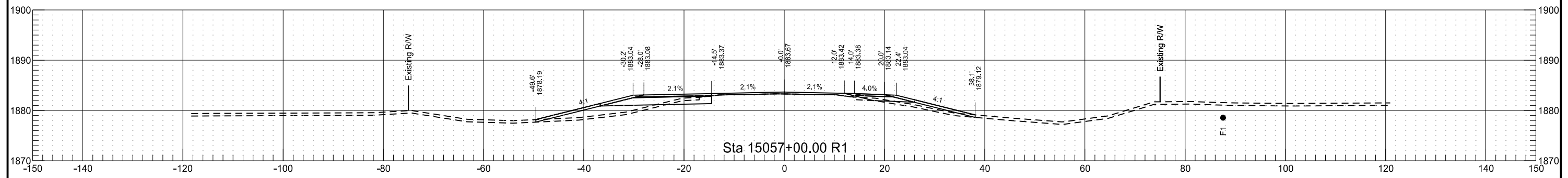
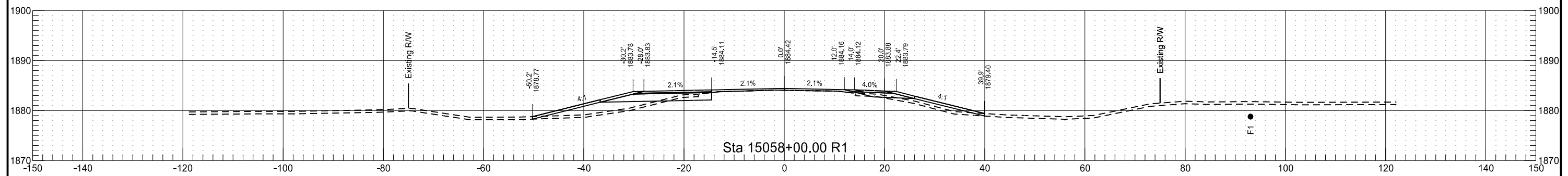

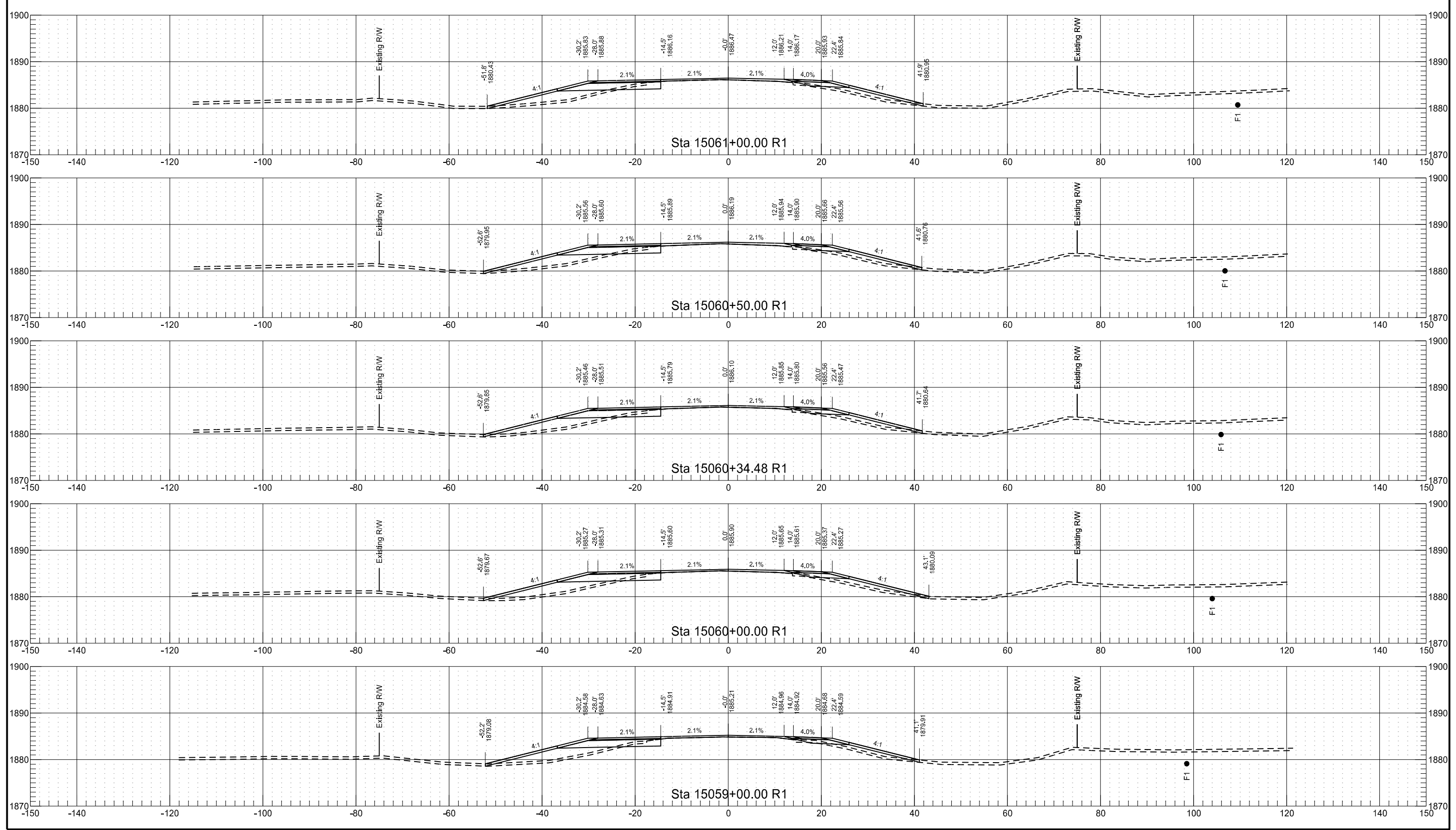

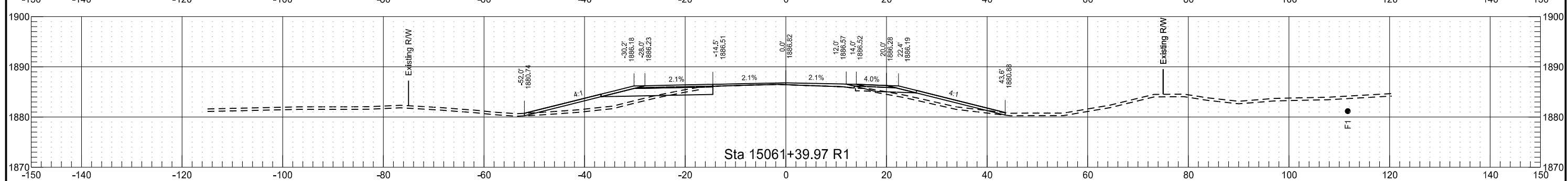
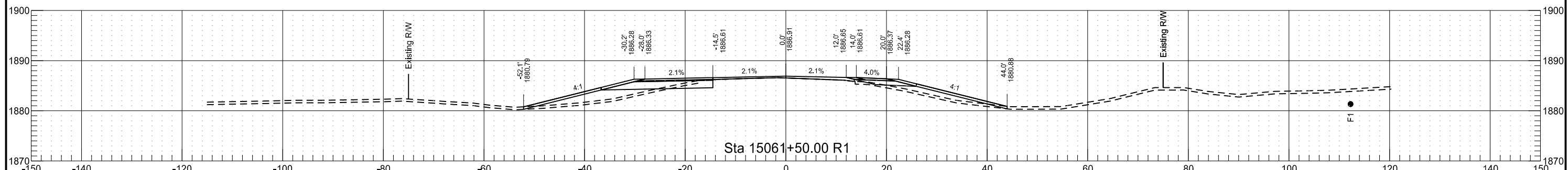
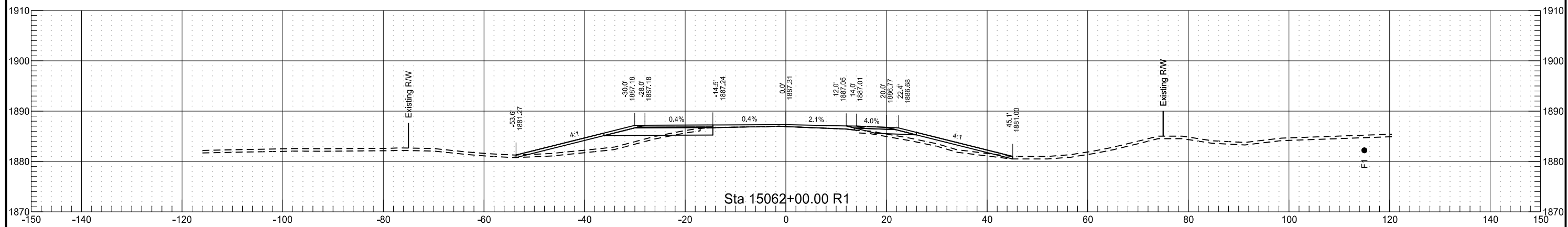
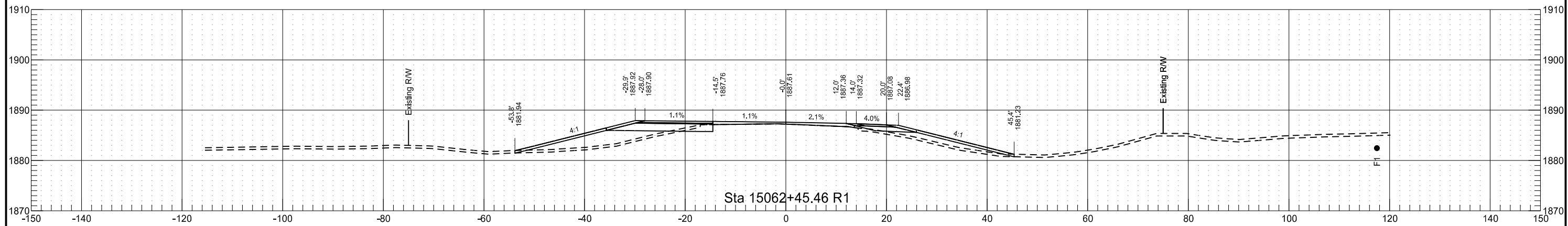

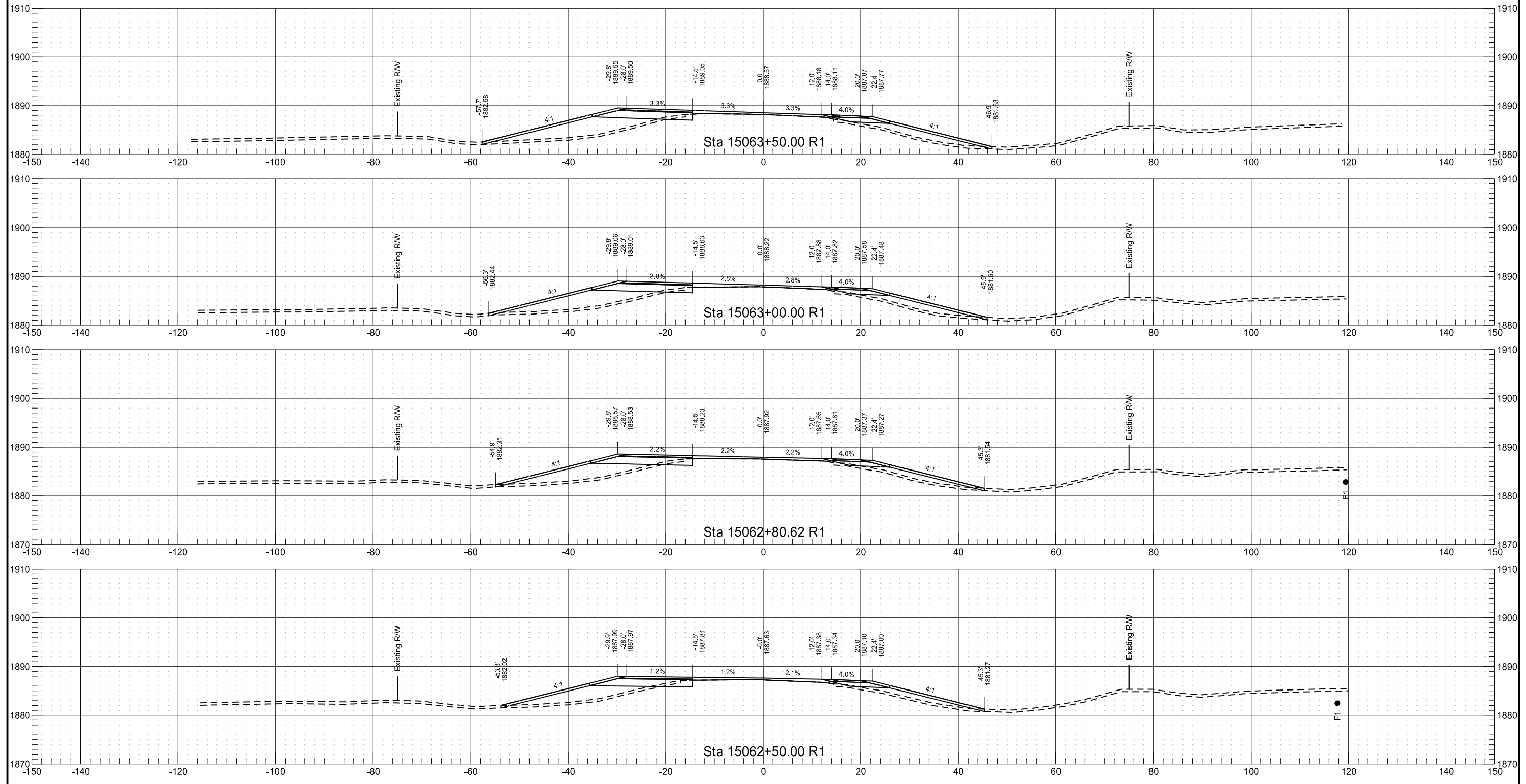

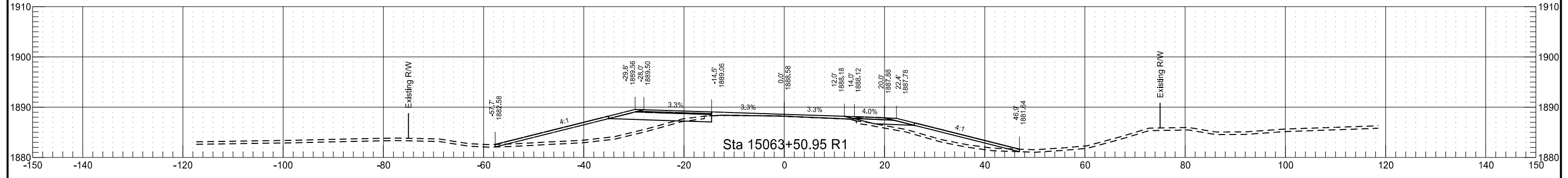
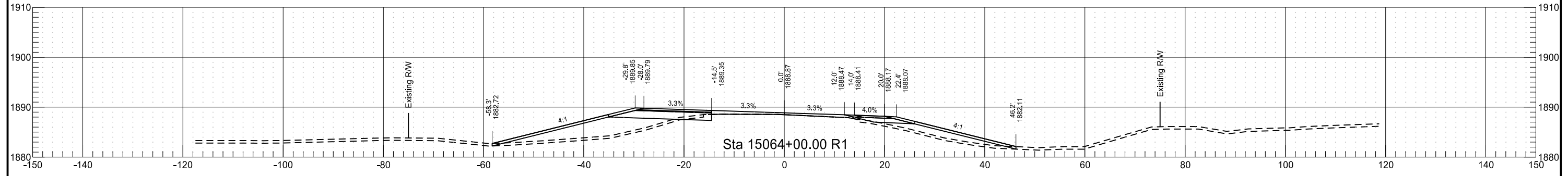
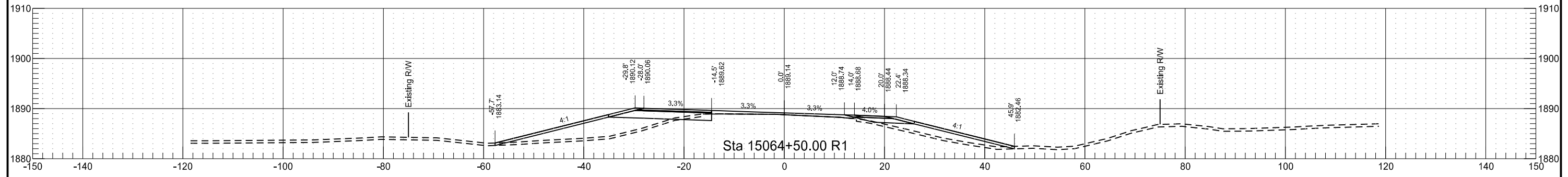
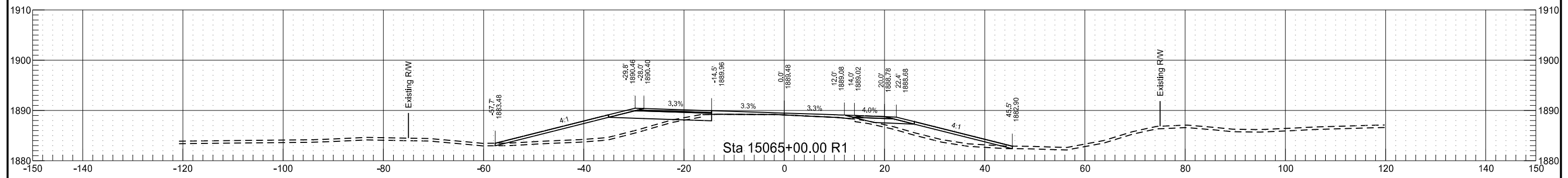
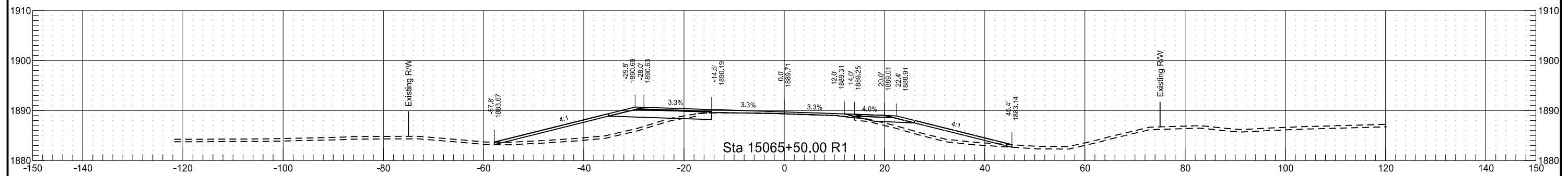

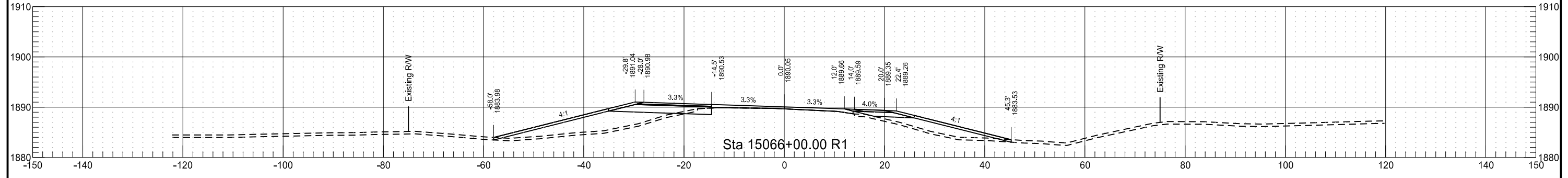
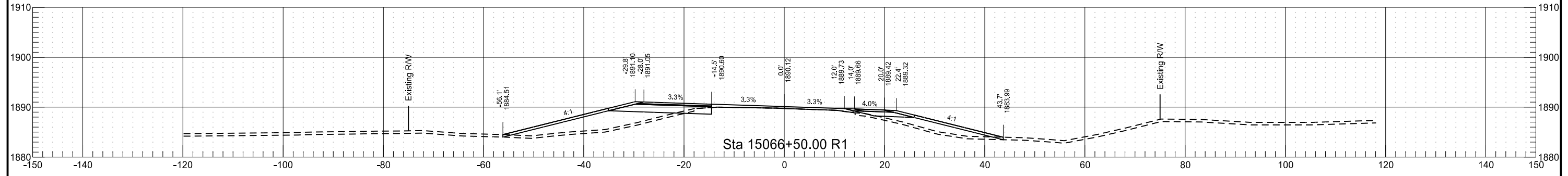
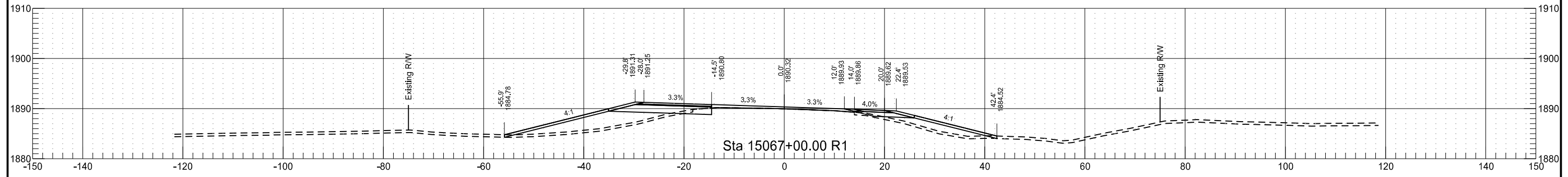
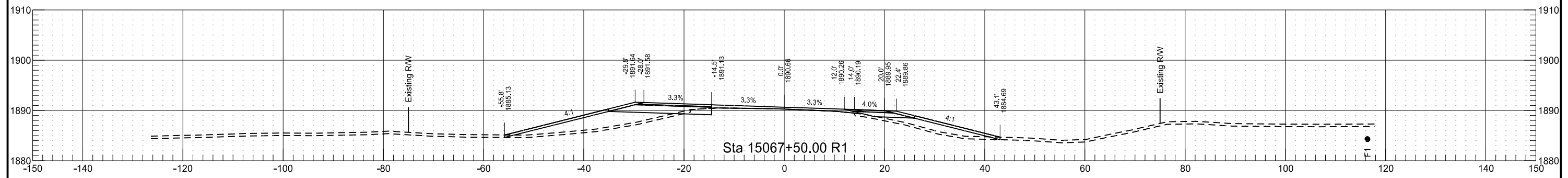
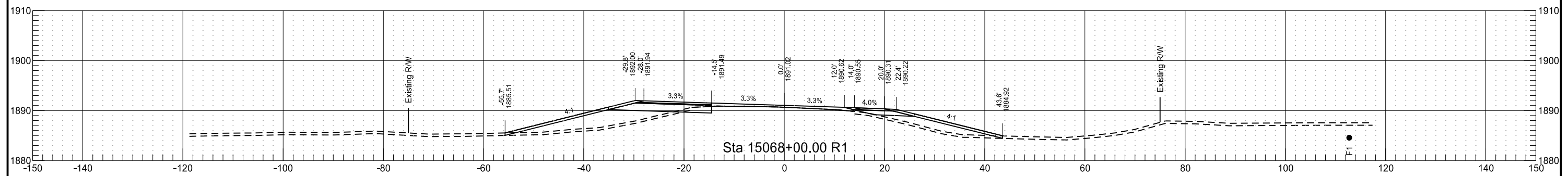

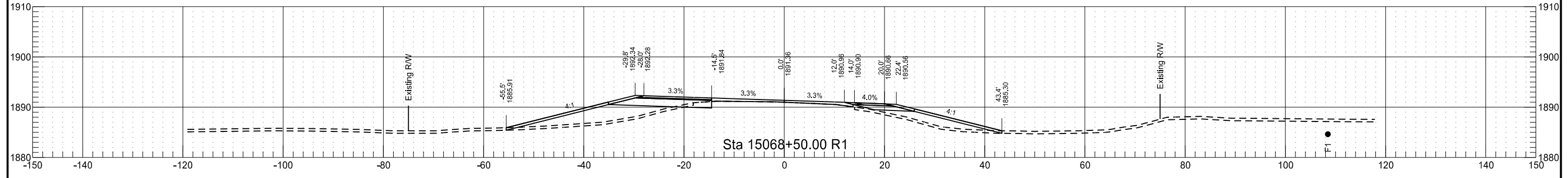
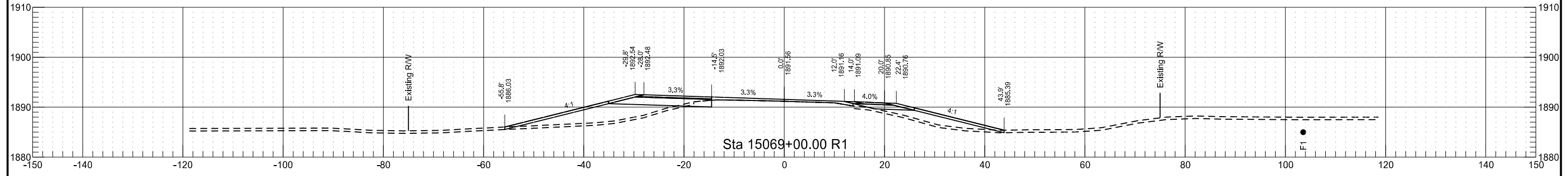
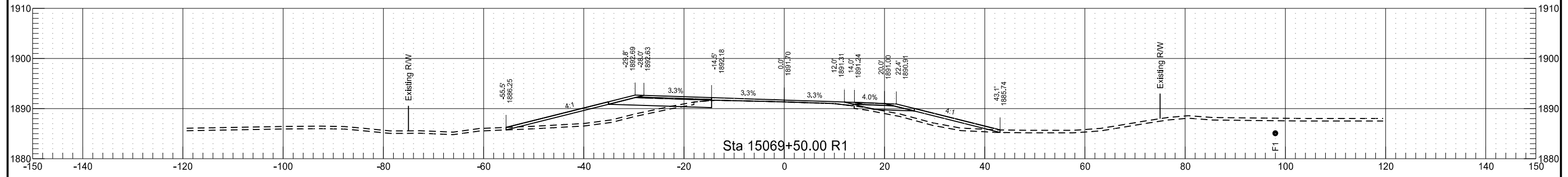
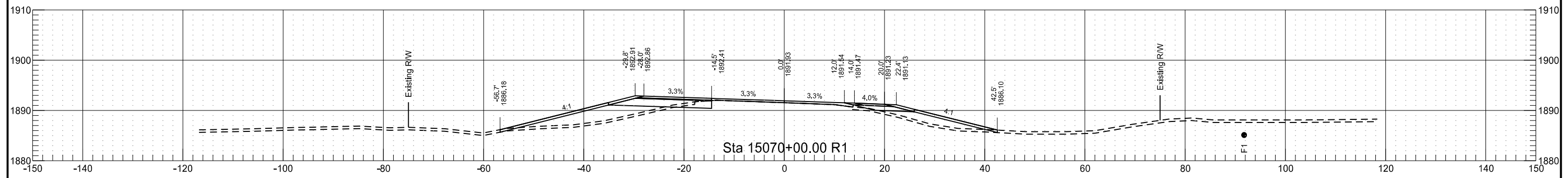
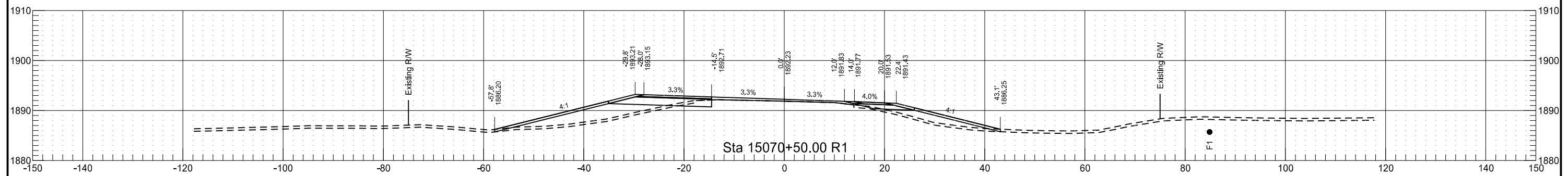

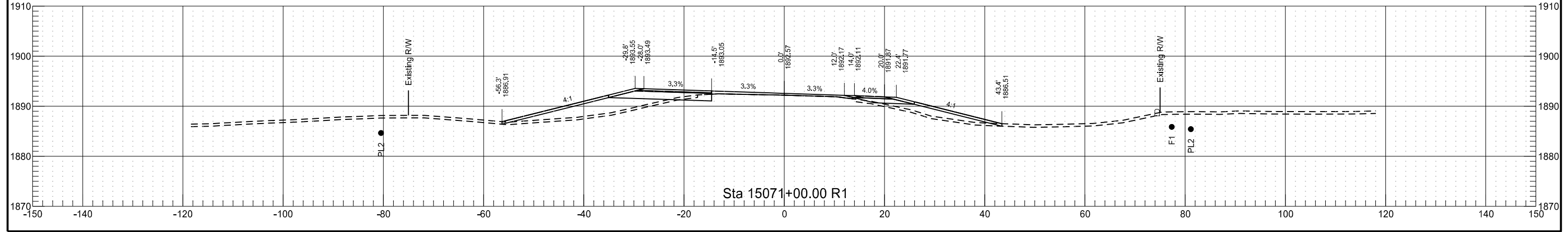
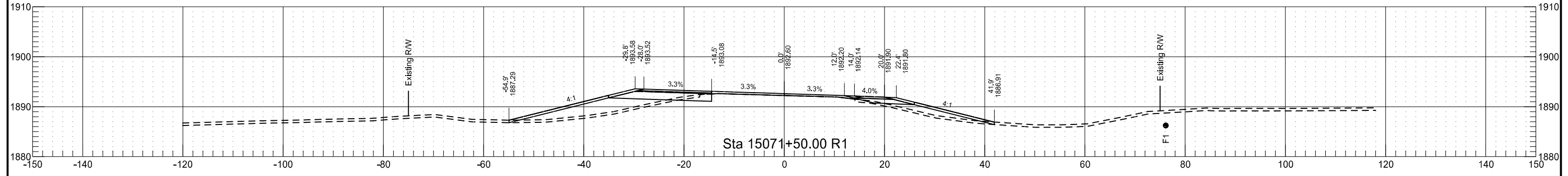
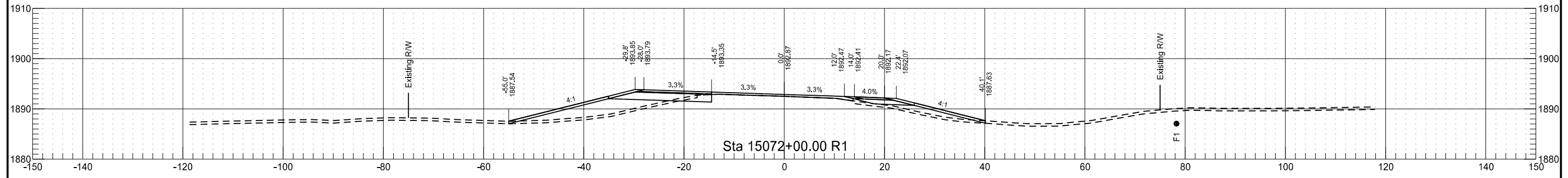
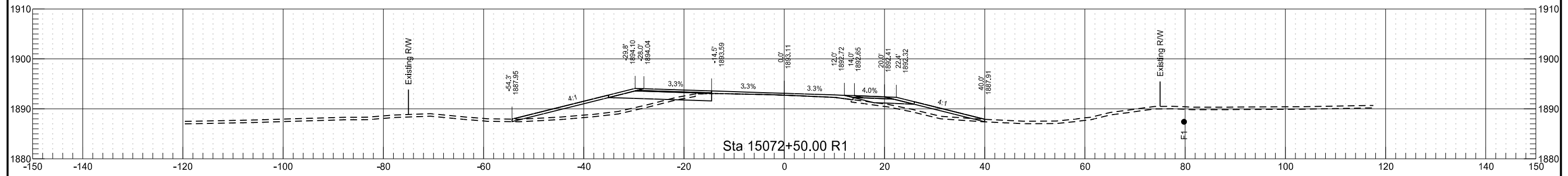
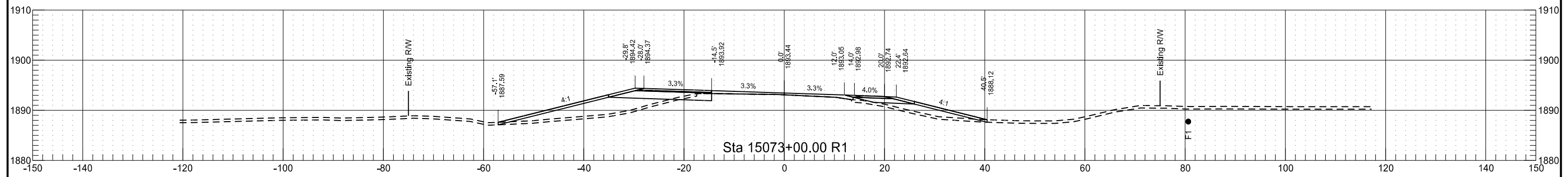

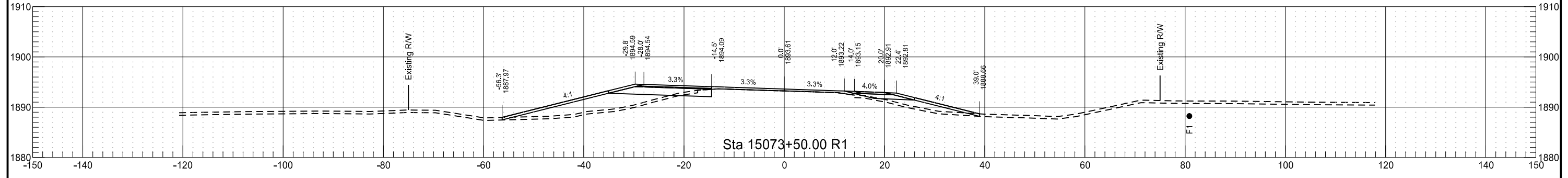
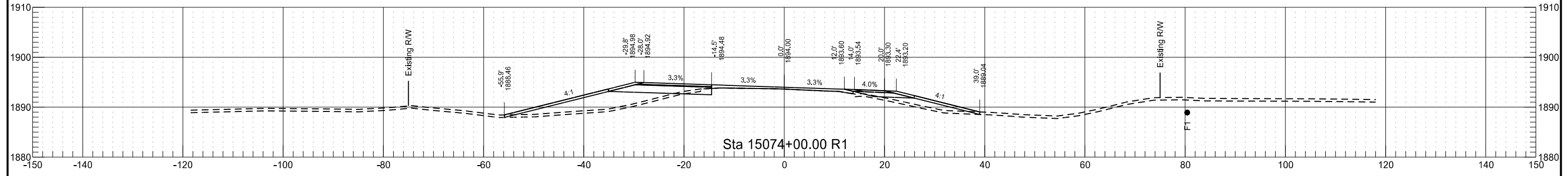
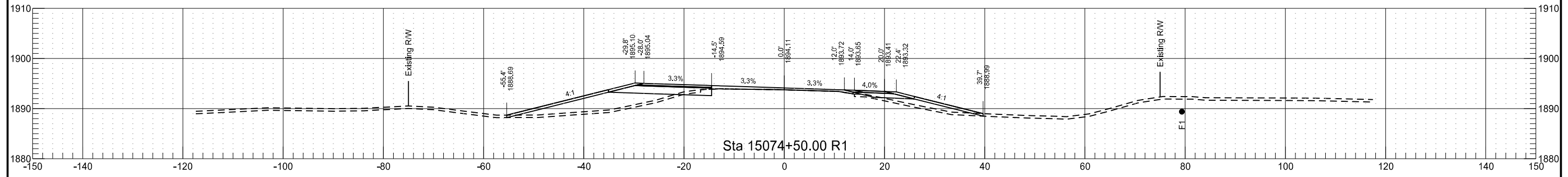
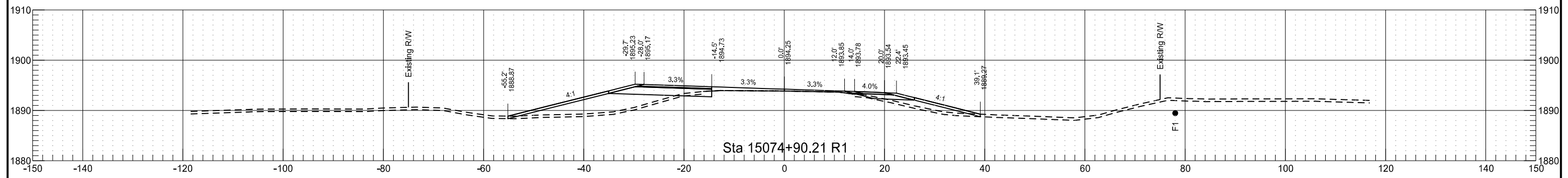
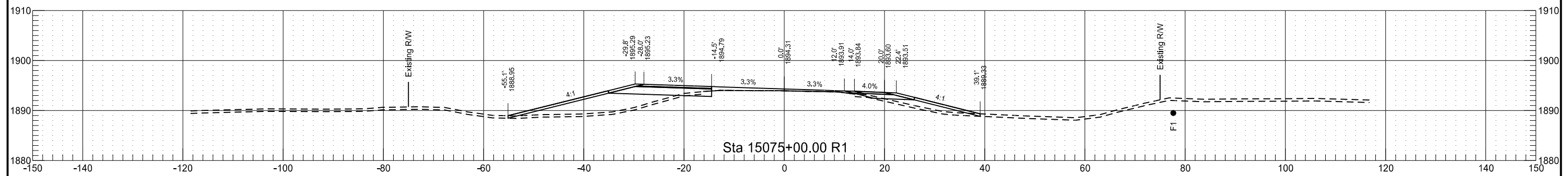

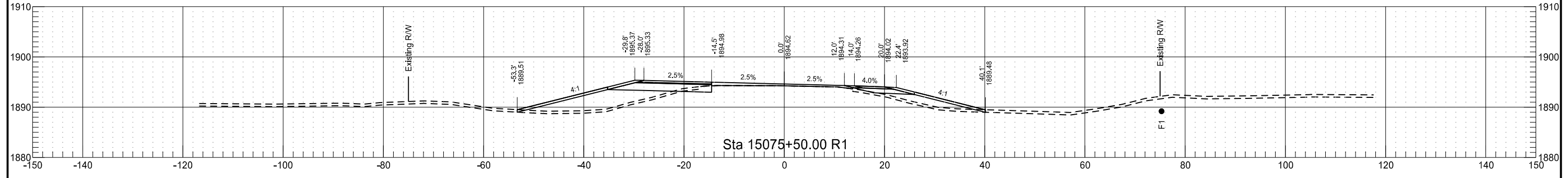
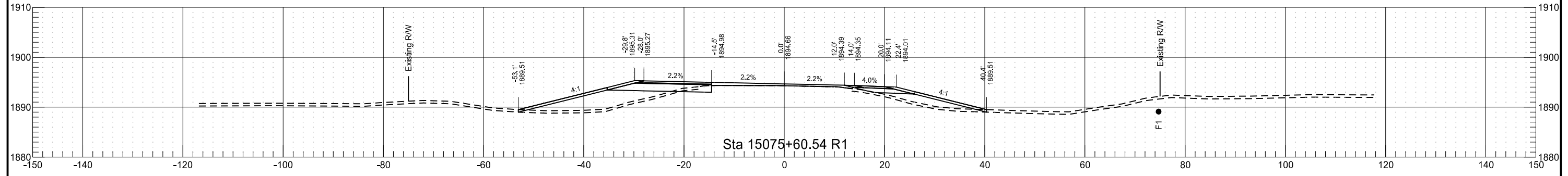
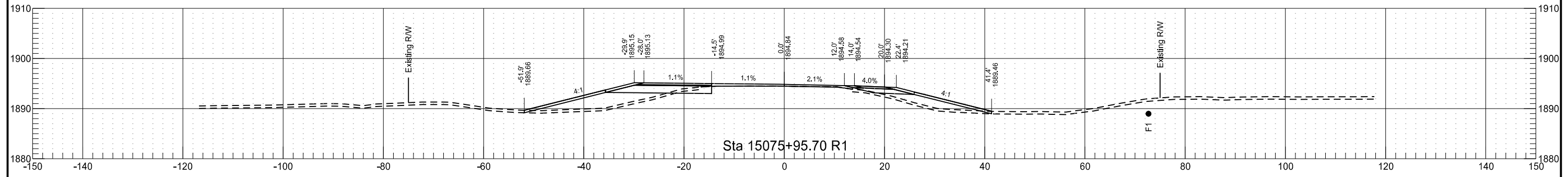
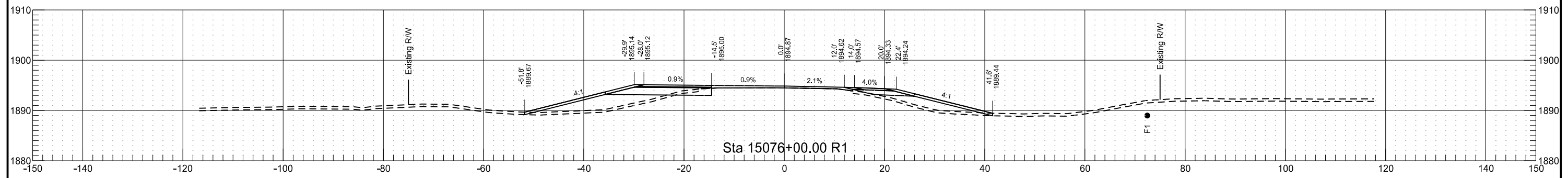
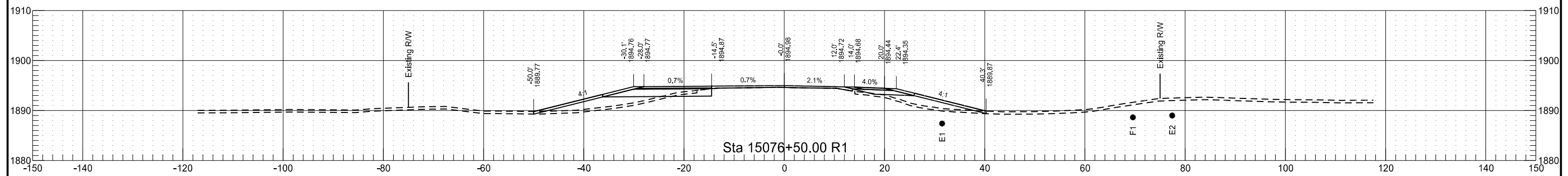

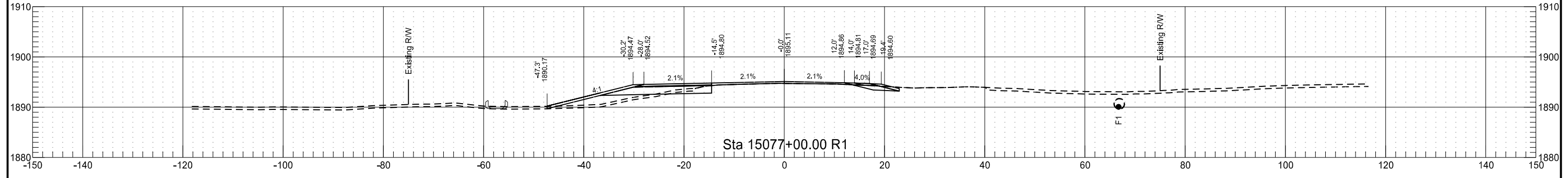
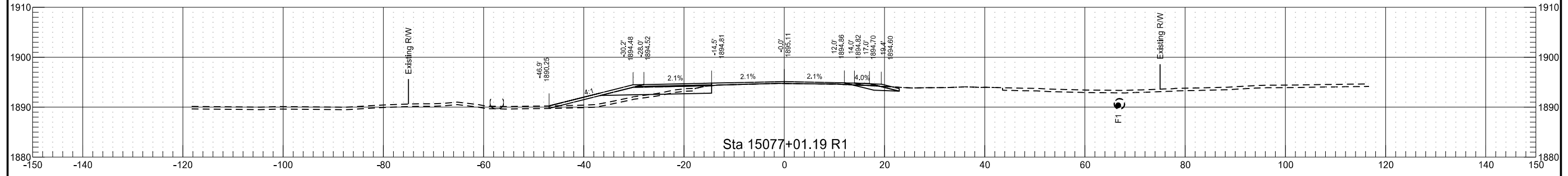
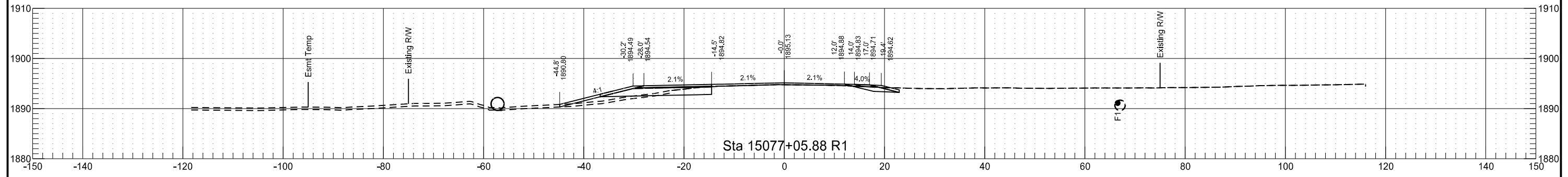
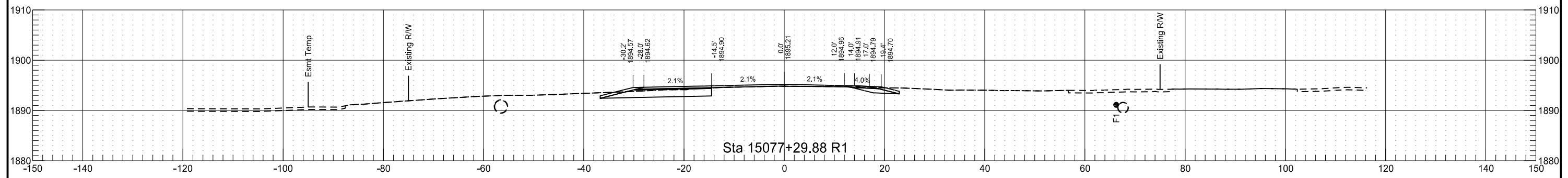
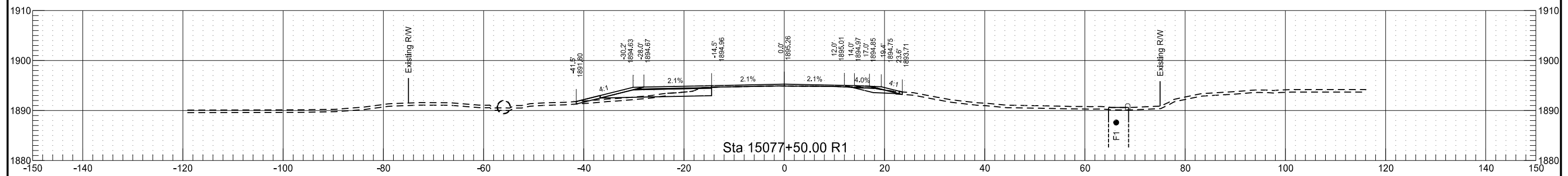

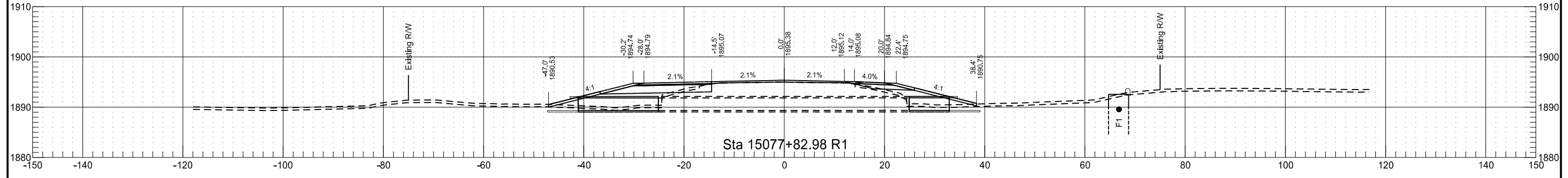
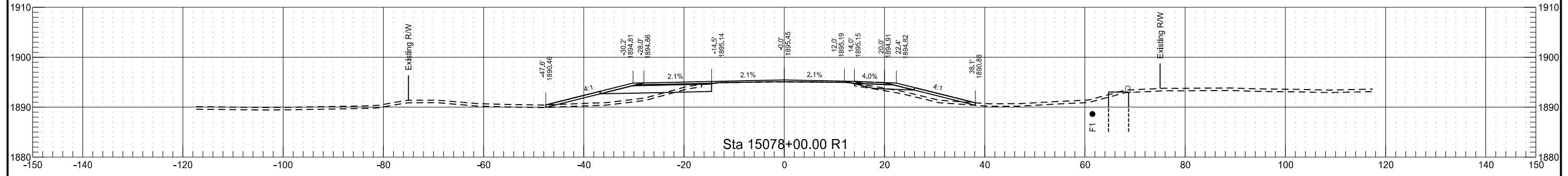
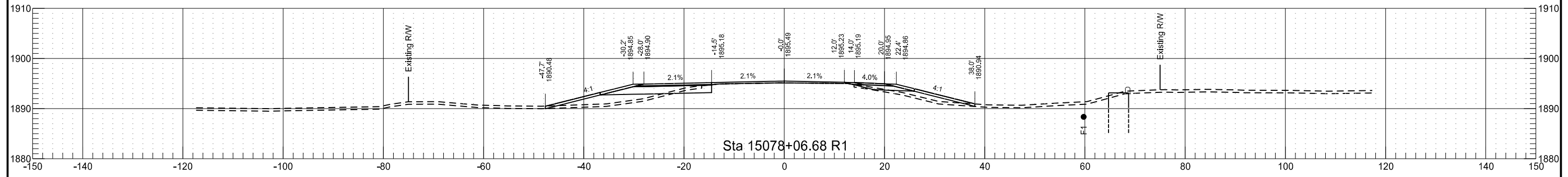
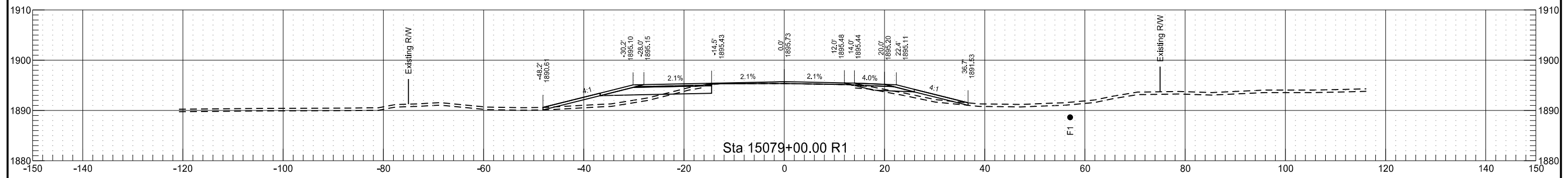
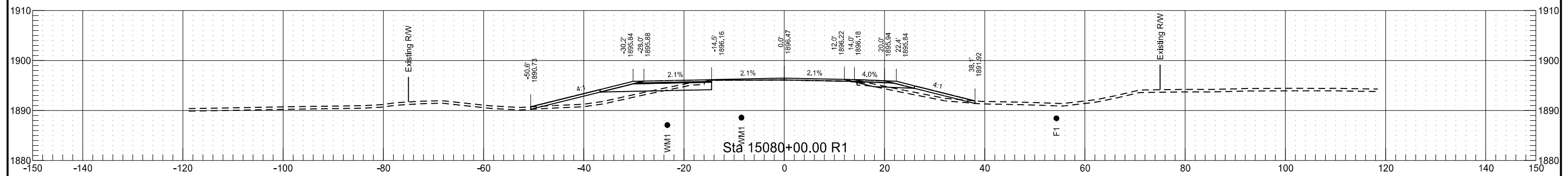

STATE	PROJECT NO.	SECTION NO.	SHEET NO.
ND	SOIB-7-804(061)283	200	37

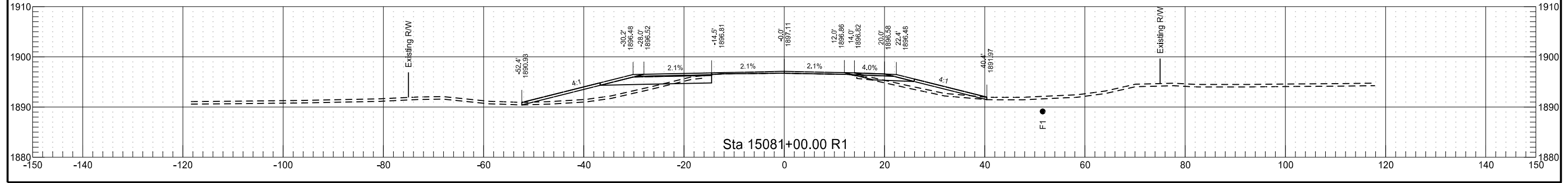
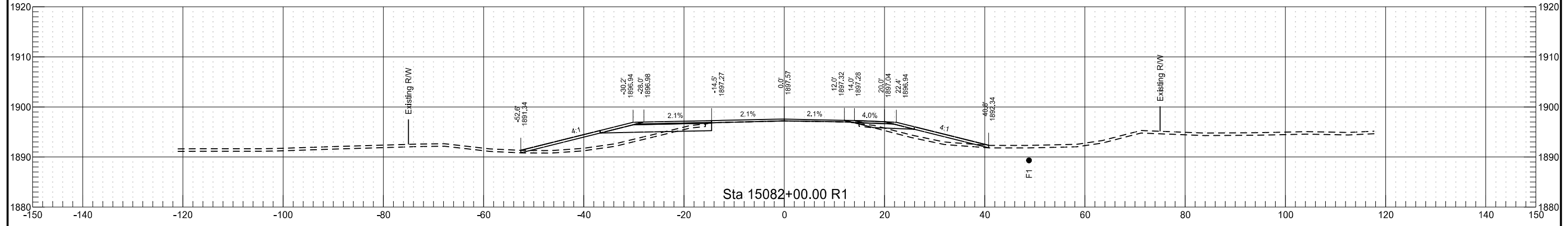
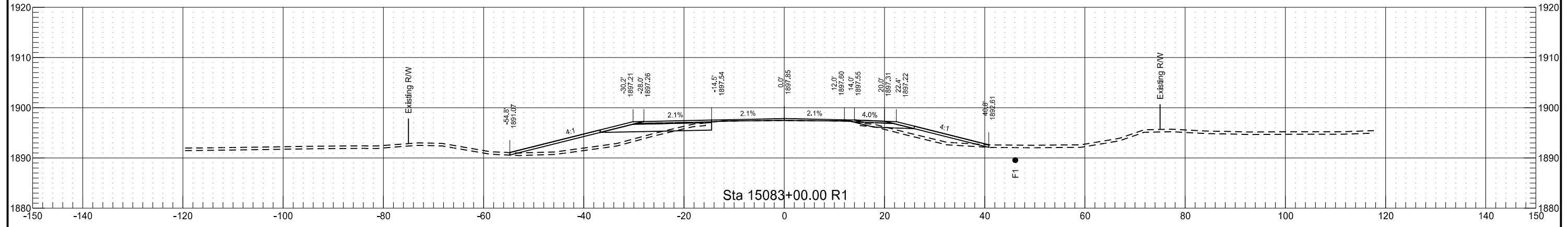
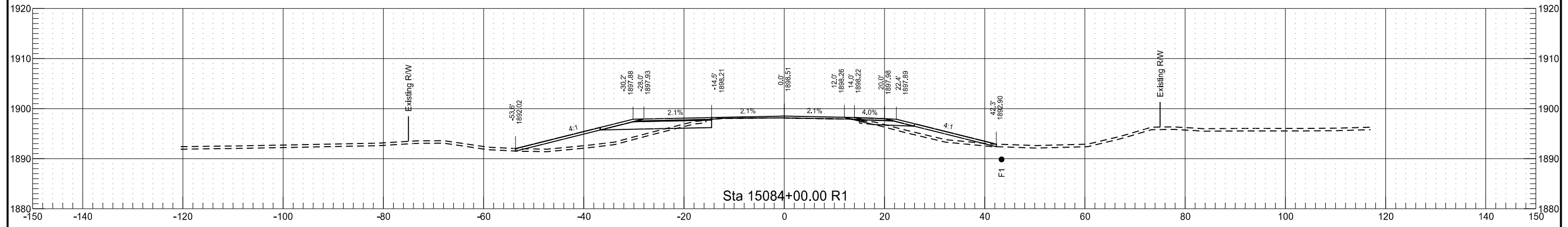

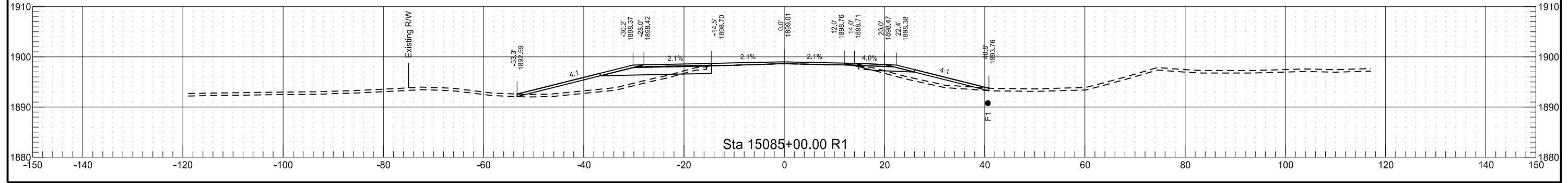
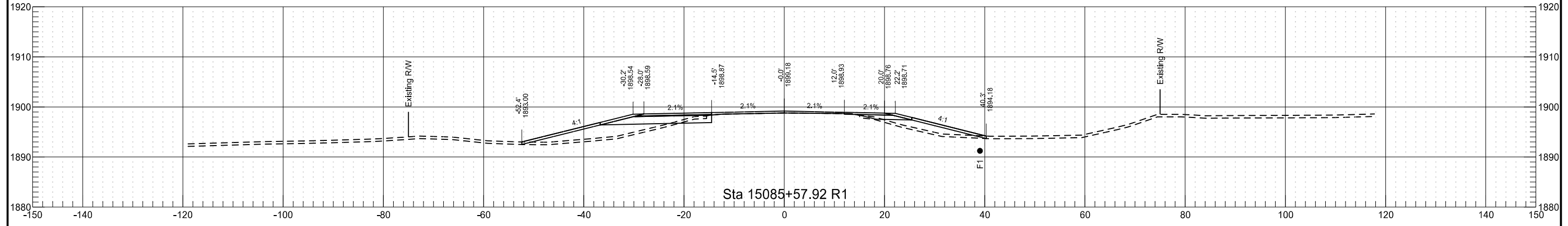
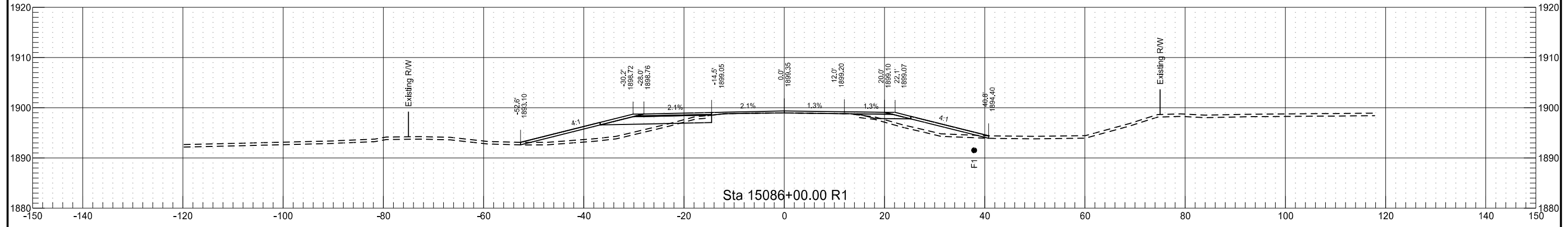
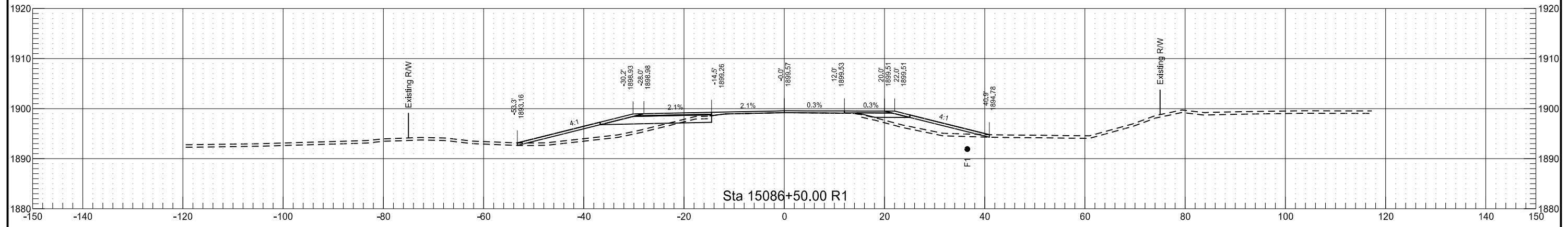

STATE	PROJECT NO.	SECTION NO.	SHEET NO.
ND	SOIB-7-804(061)283	200	39

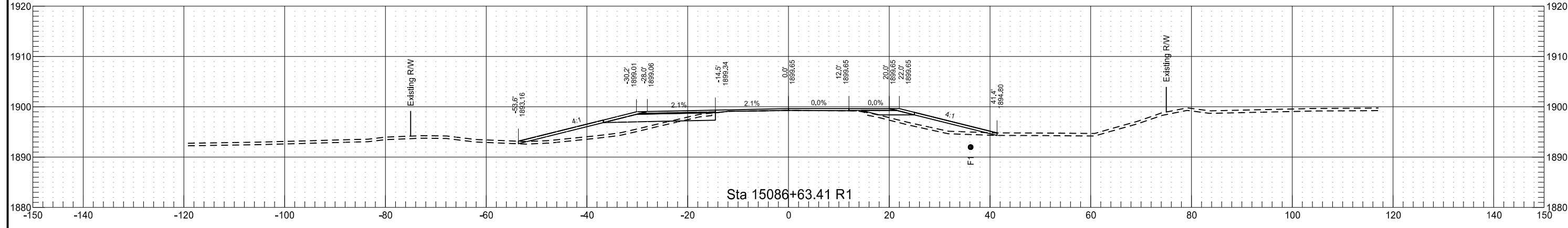
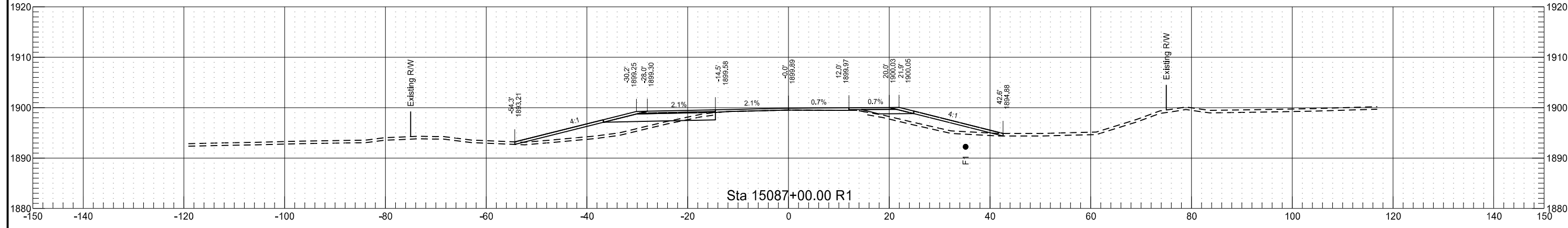
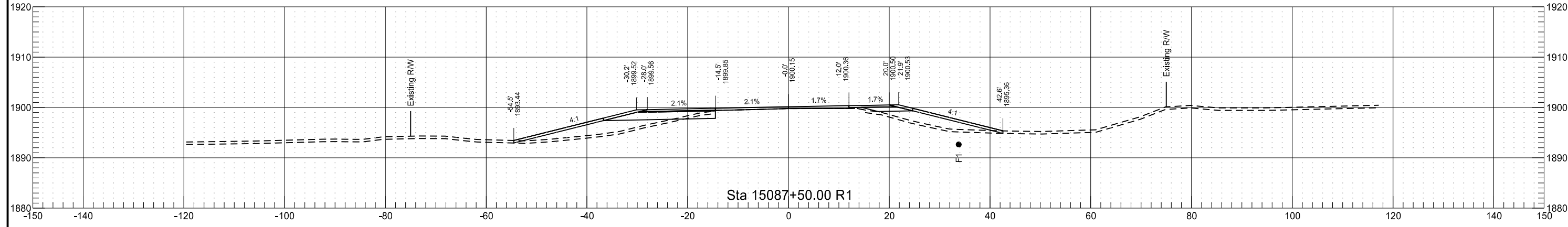
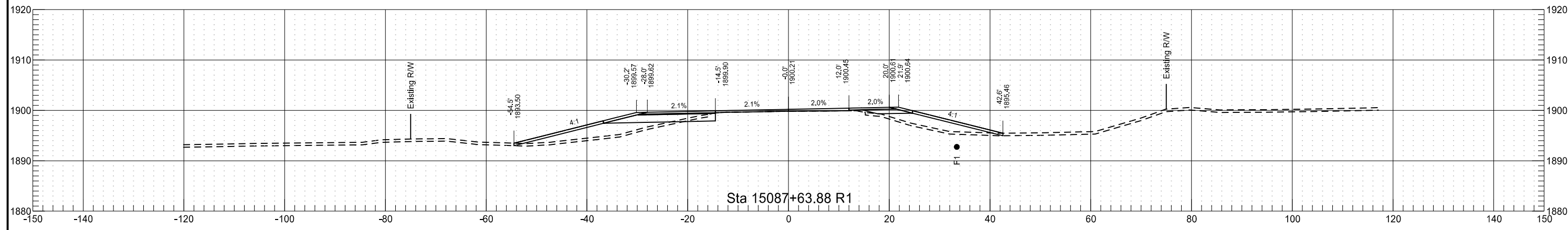

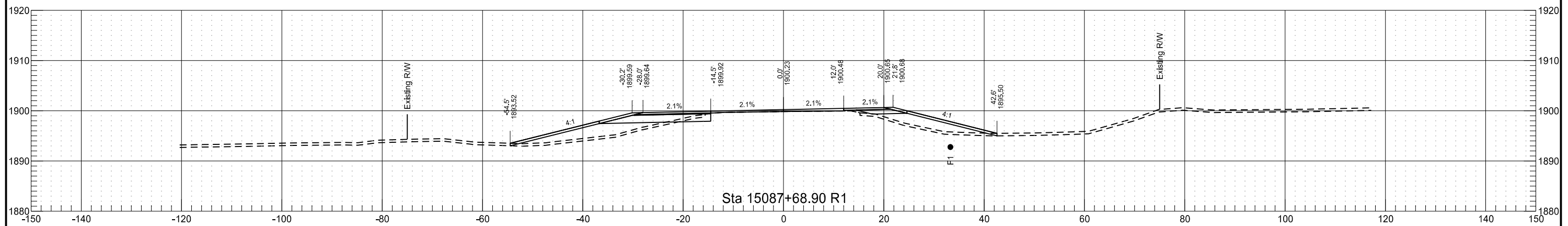
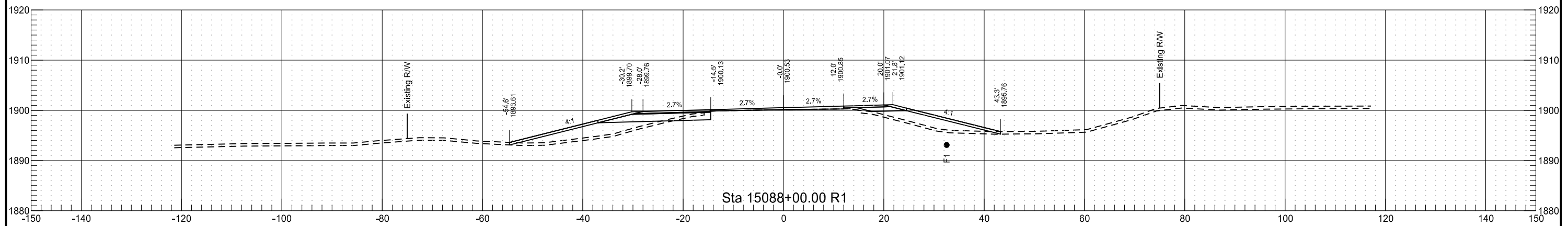
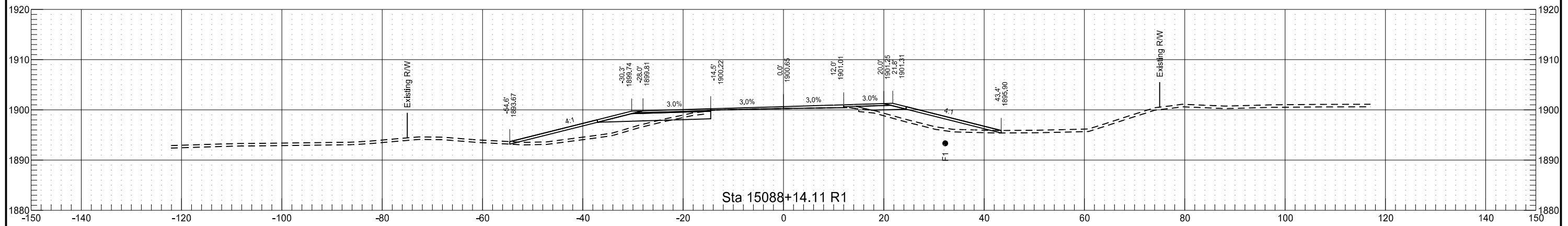
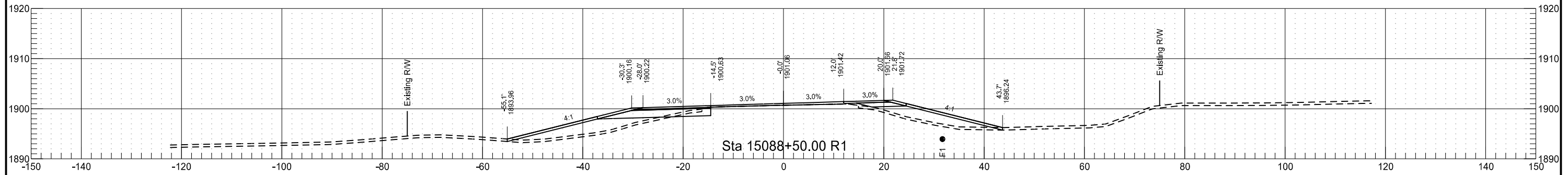

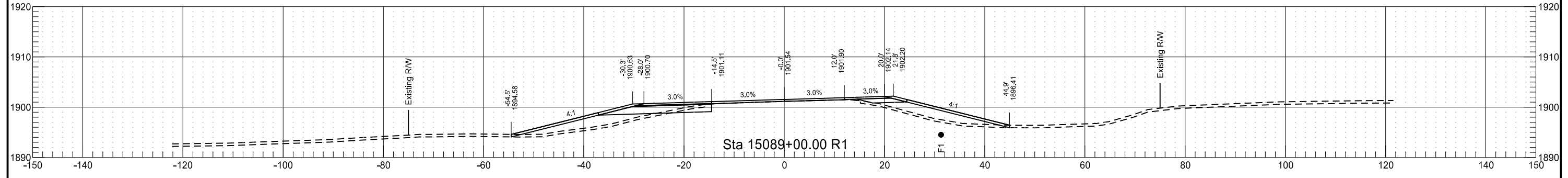
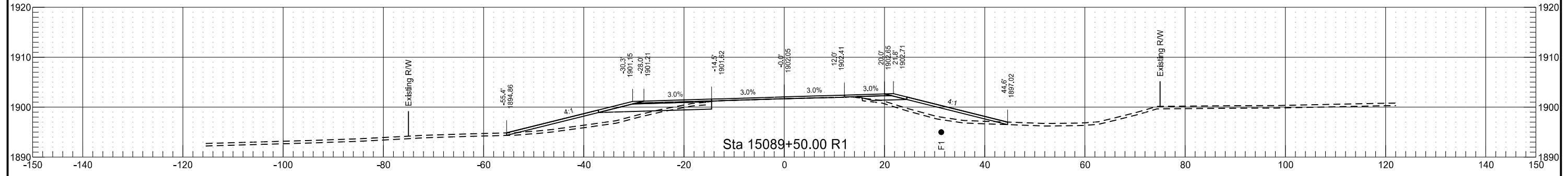
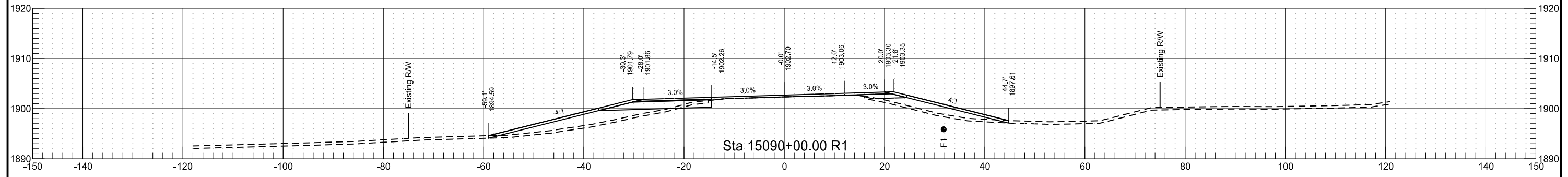
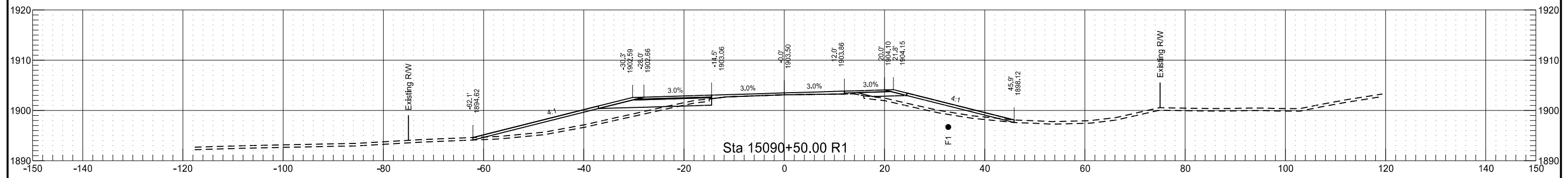
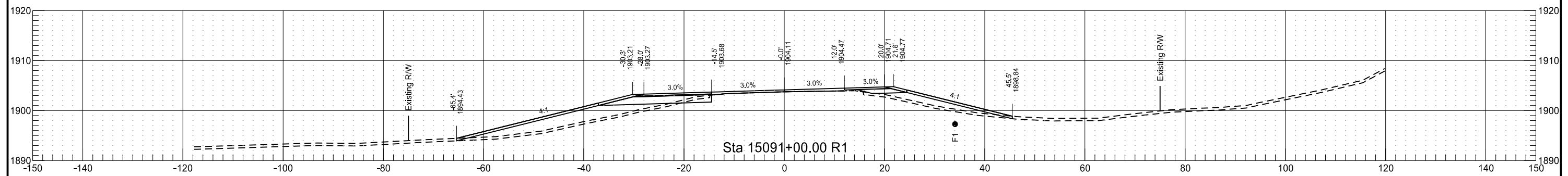

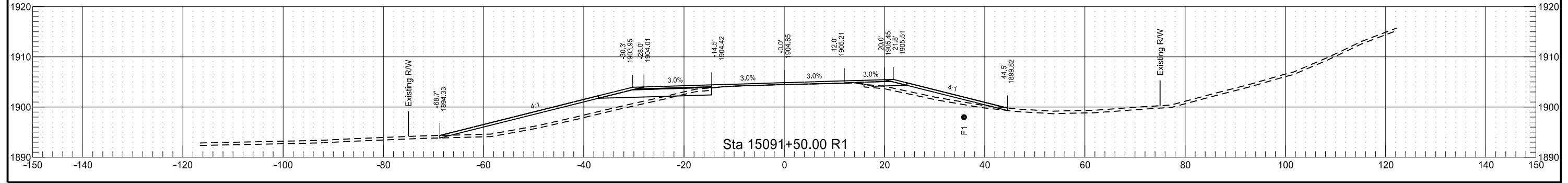
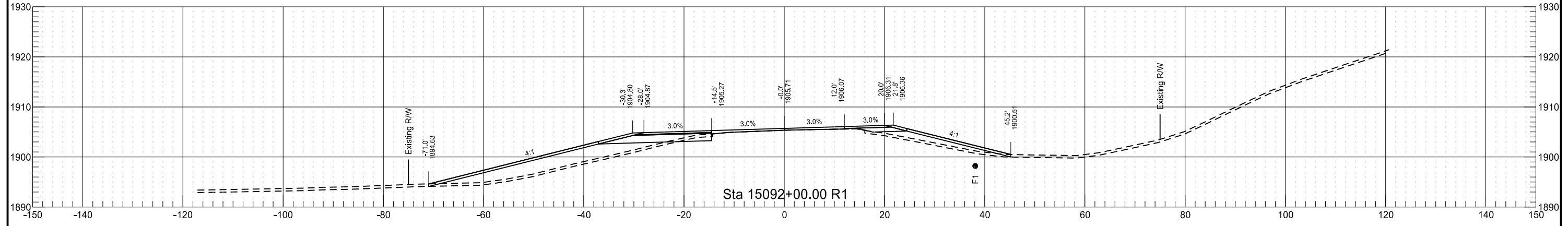
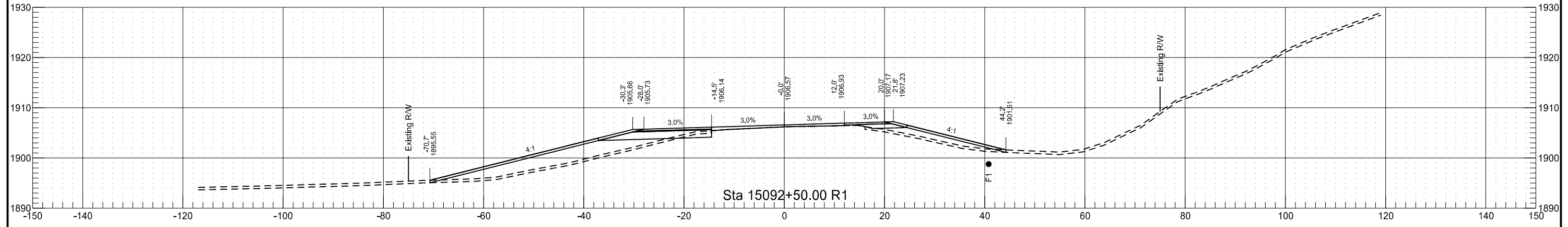
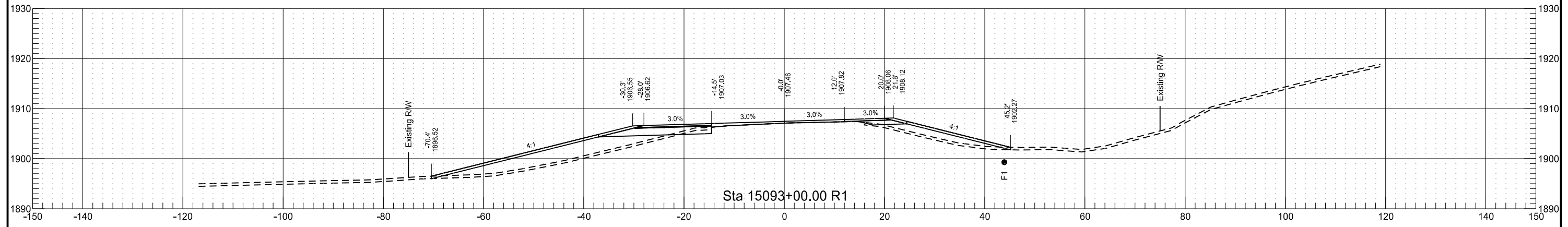

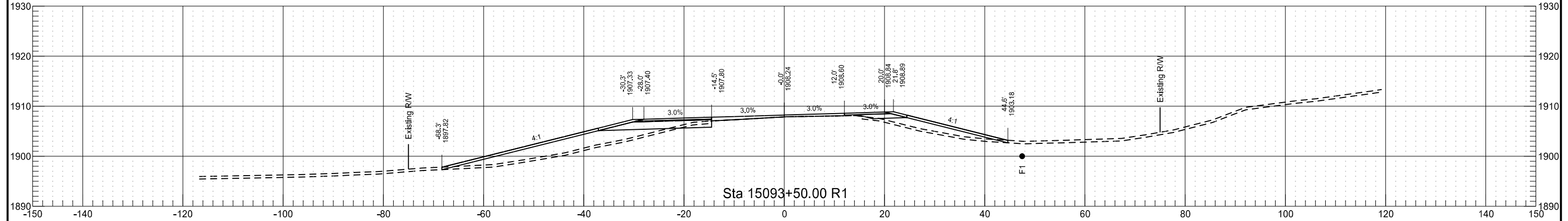
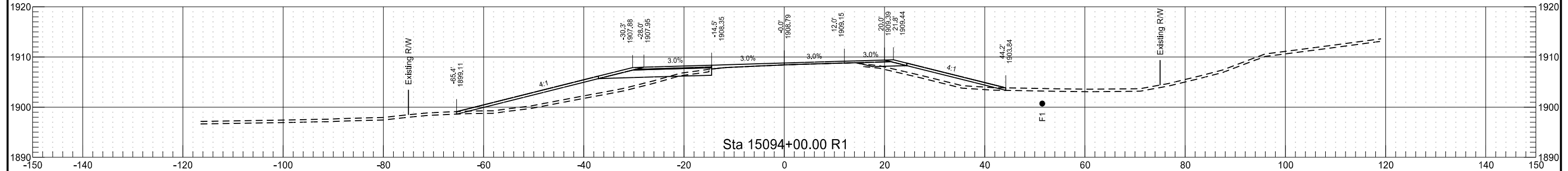
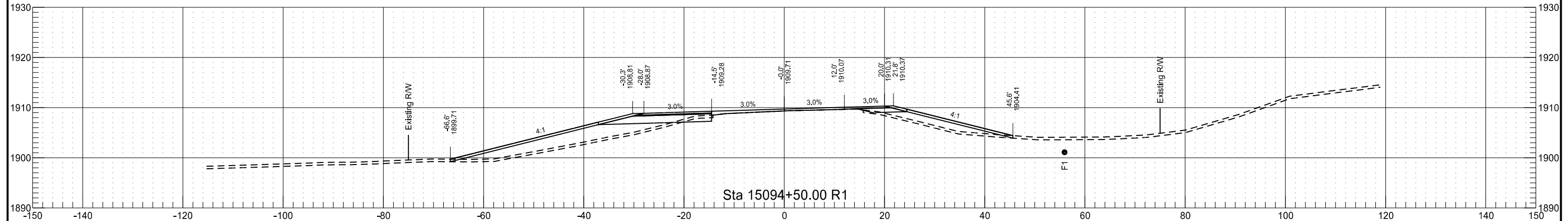
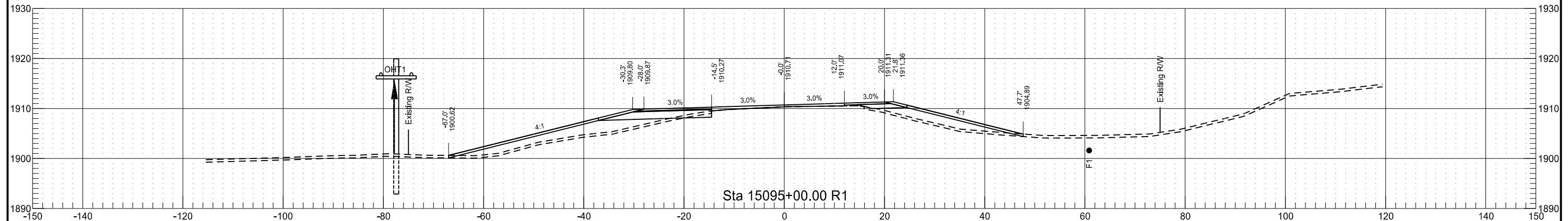

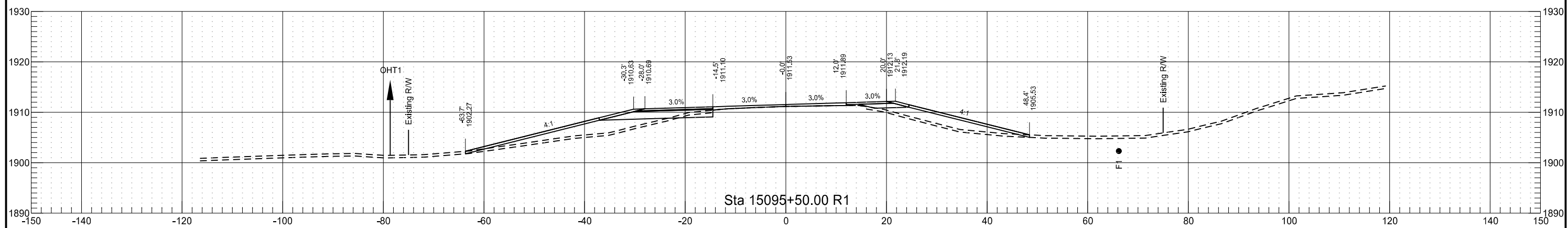
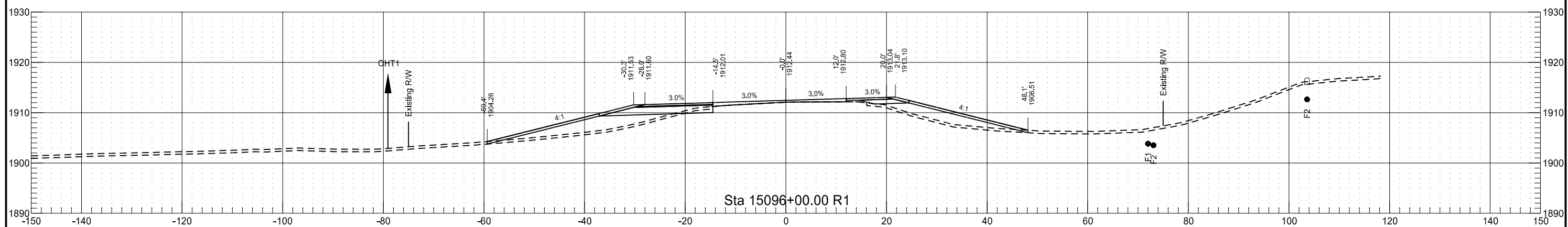
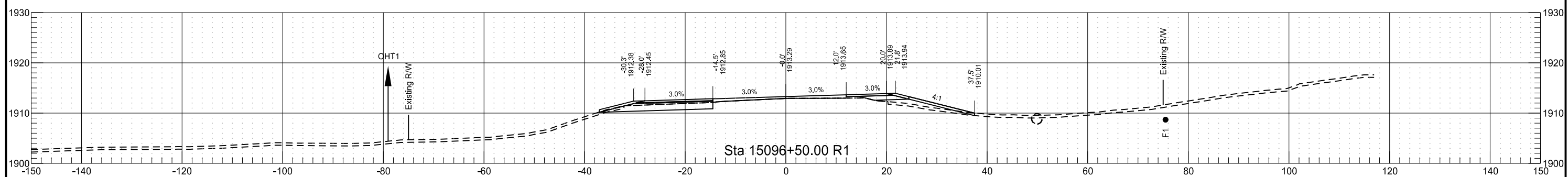
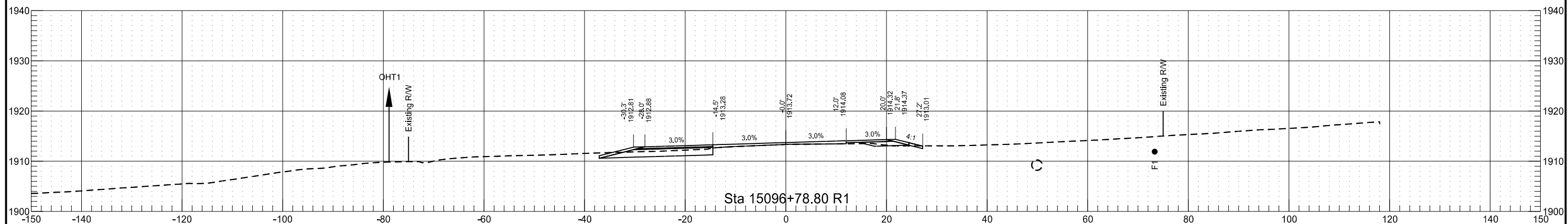

STATE	PROJECT NO.	SECTION NO.	SHEET NO.
ND	SOIB-7-804(061)283	200	45

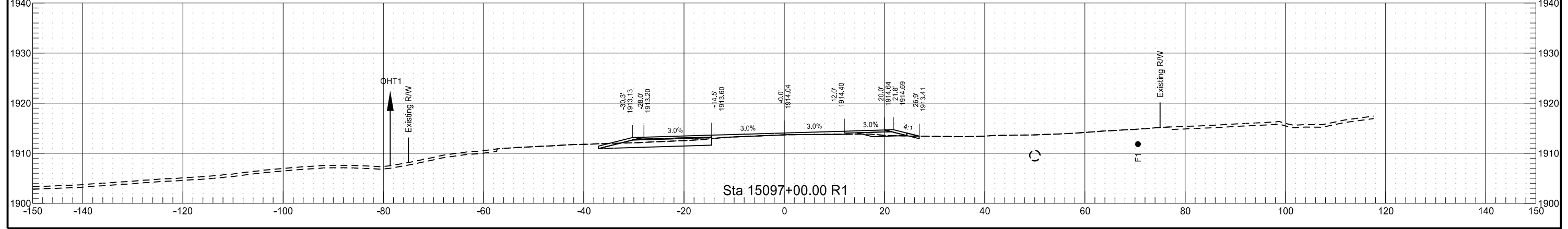
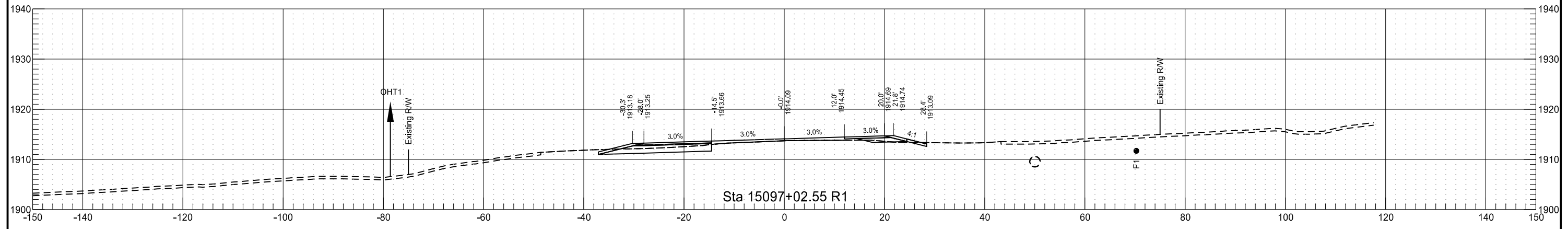
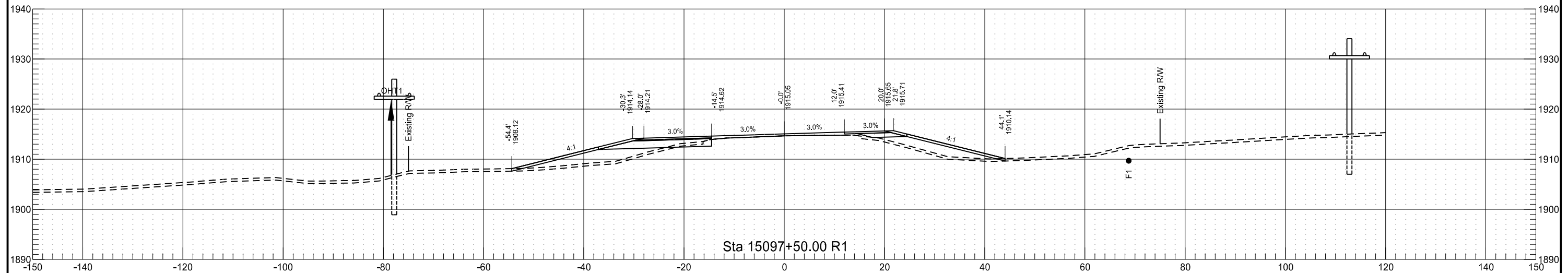

STATE	PROJECT NO.	SECTION NO.	SHEET NO.
ND	SOIB-7-804(061)283	200	46

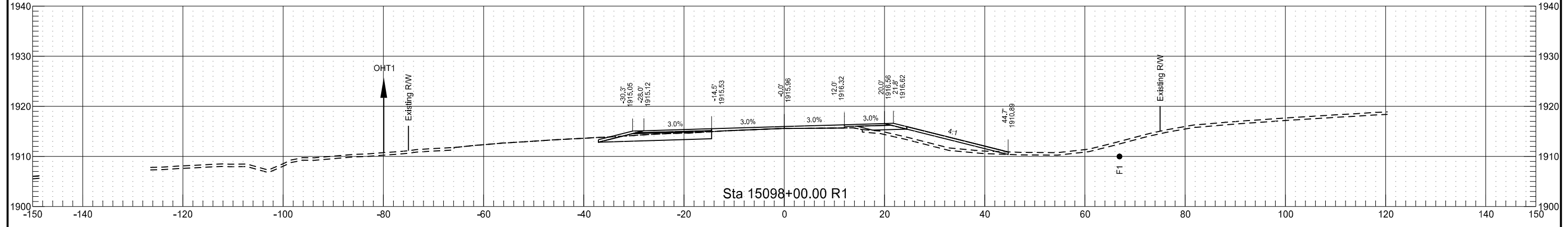
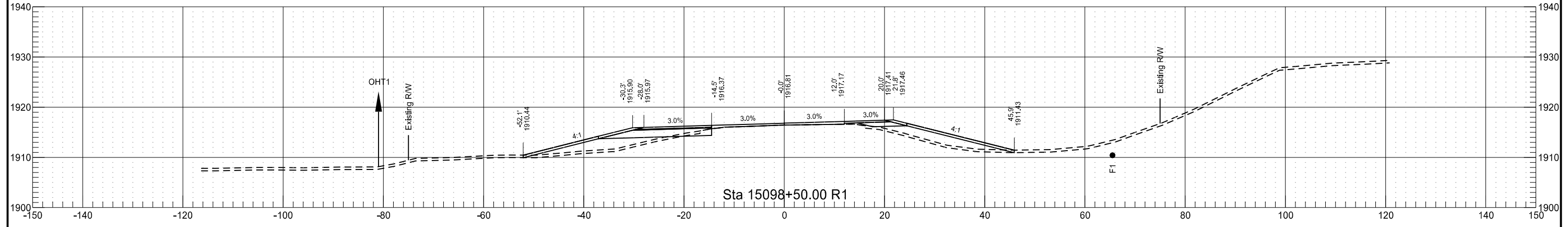
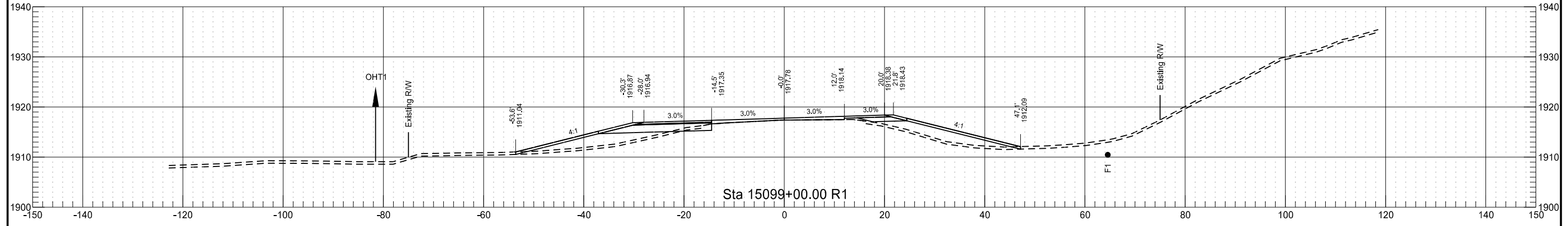
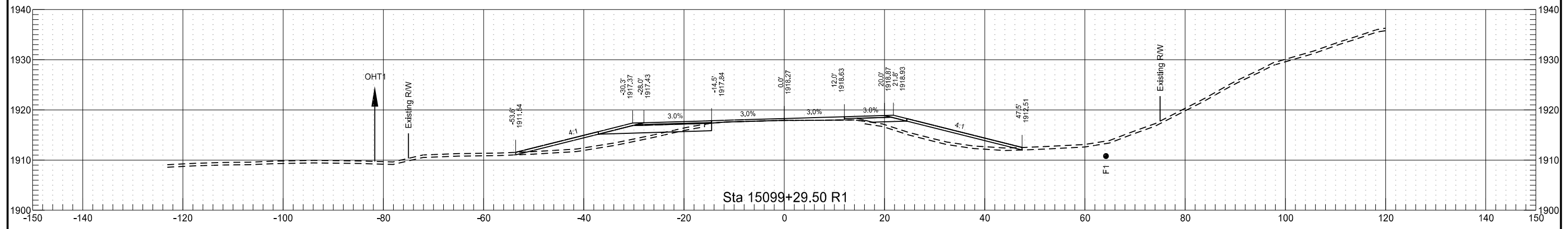

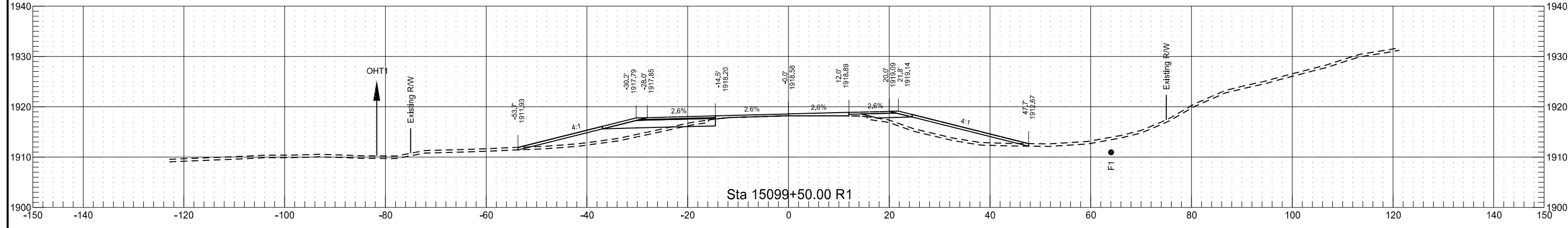
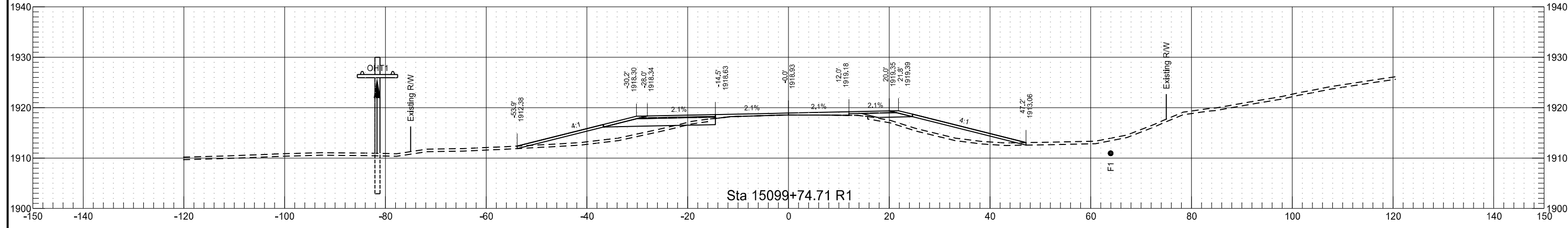
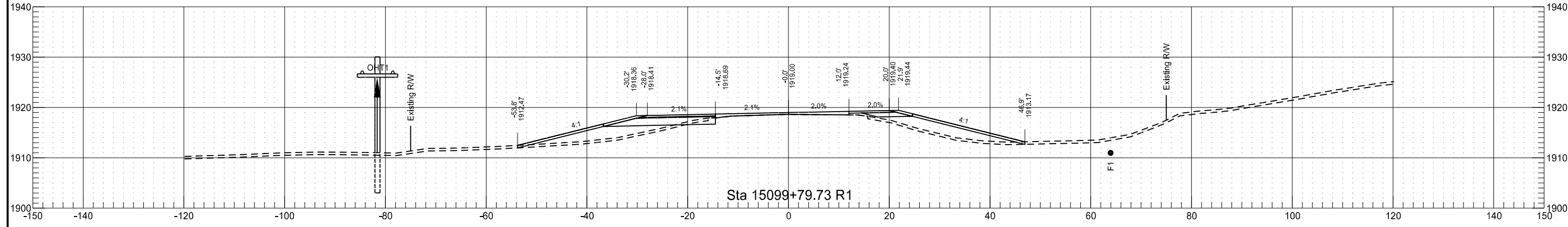
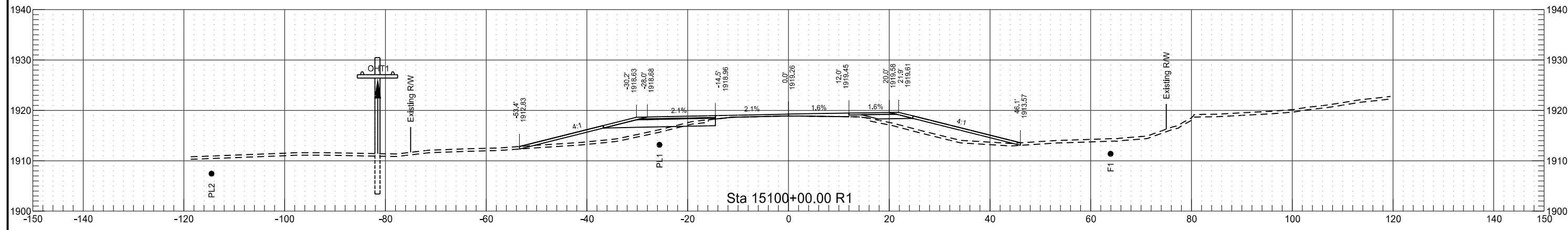

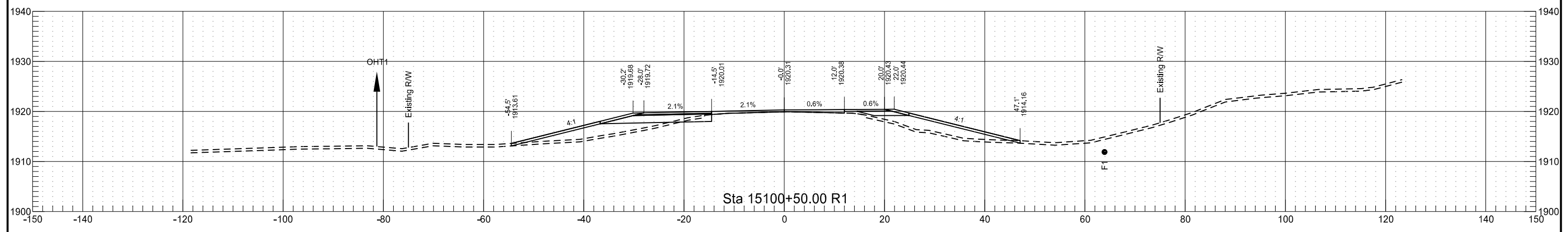
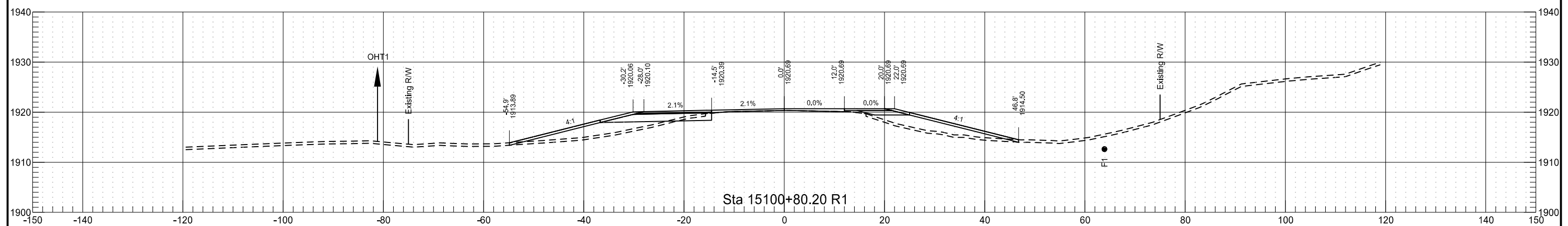
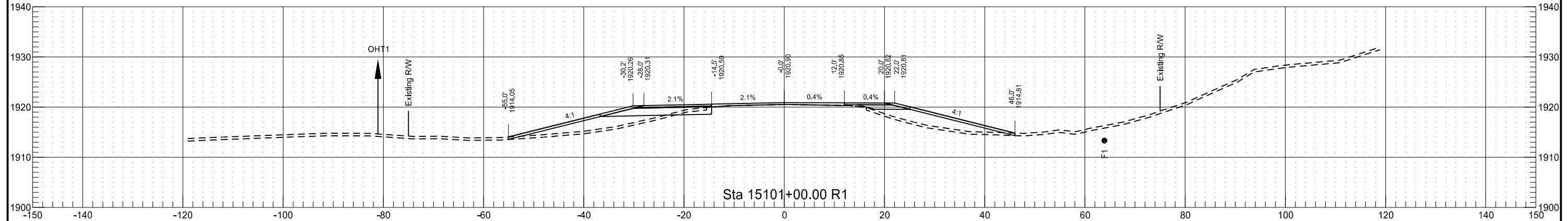
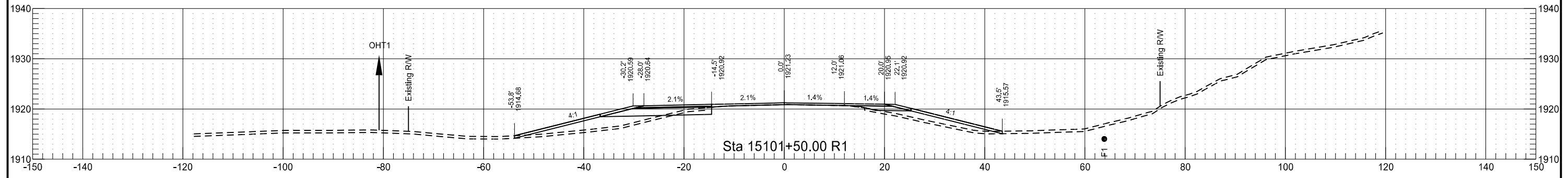

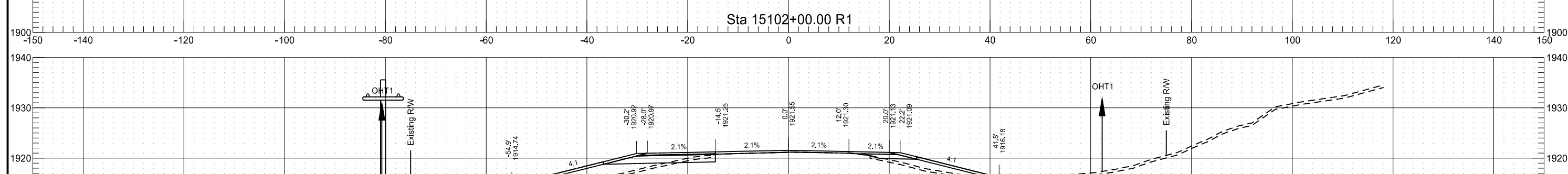
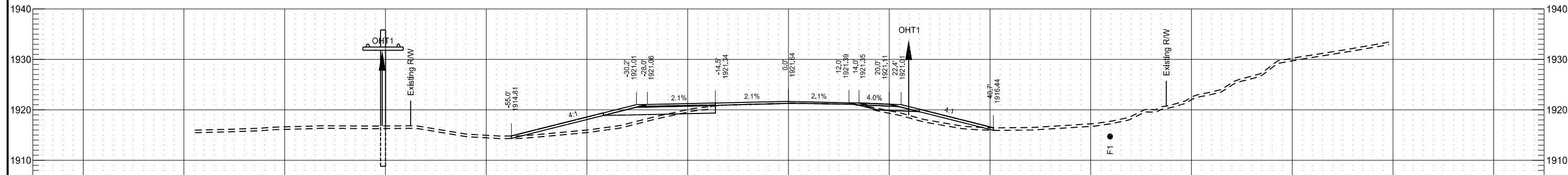
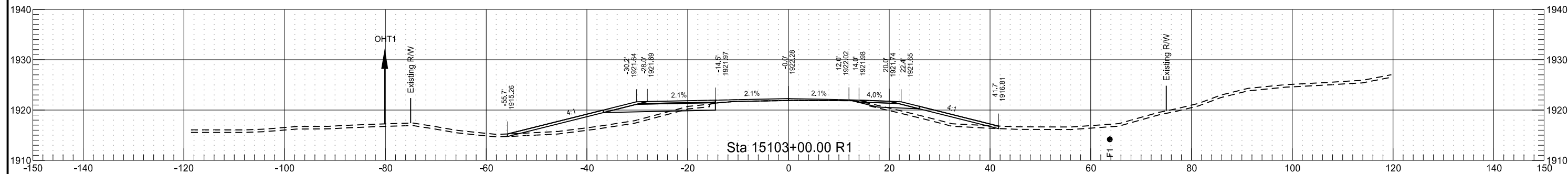
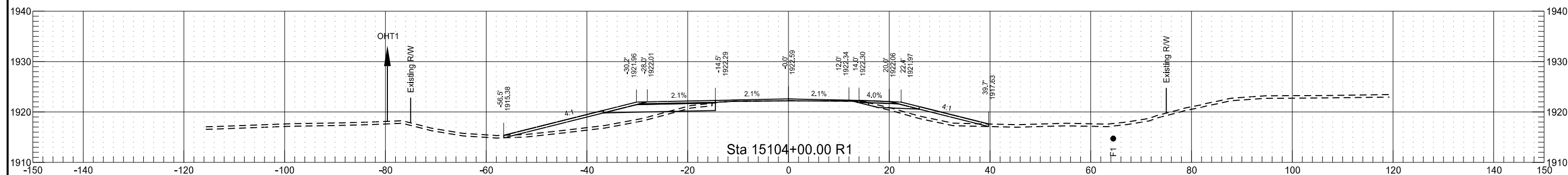

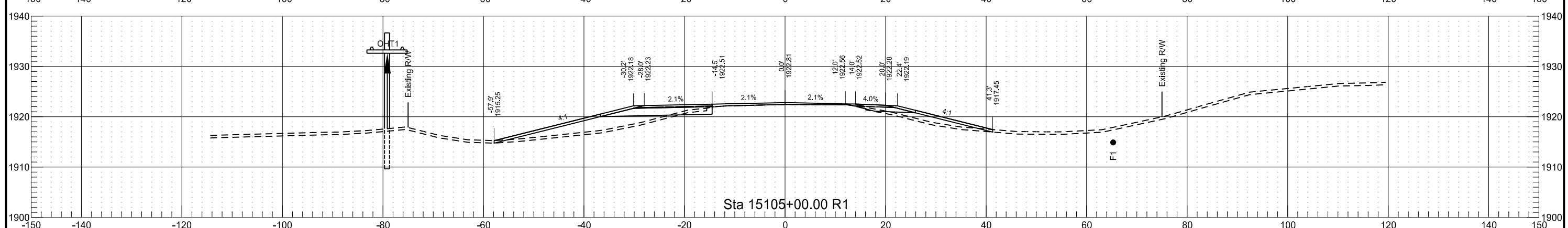
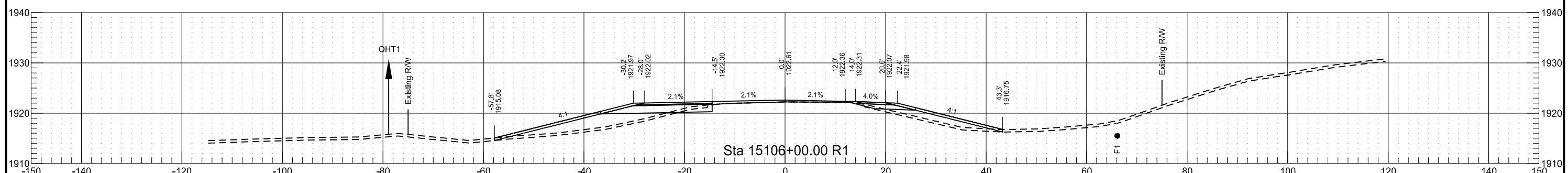
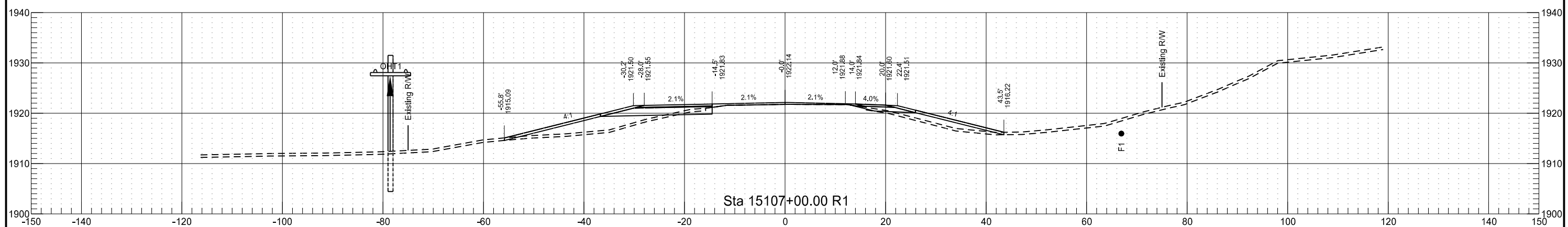
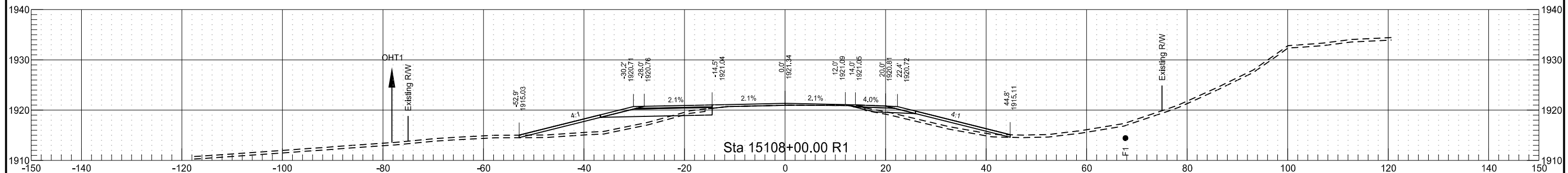

STATE	PROJECT NO.	SECTION NO.	SHEET NO.
ND	SOIB-7-804(061)283	200	51

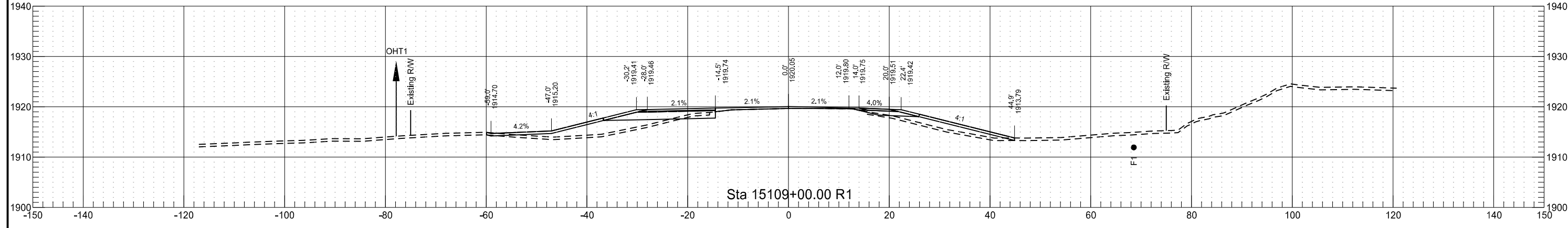
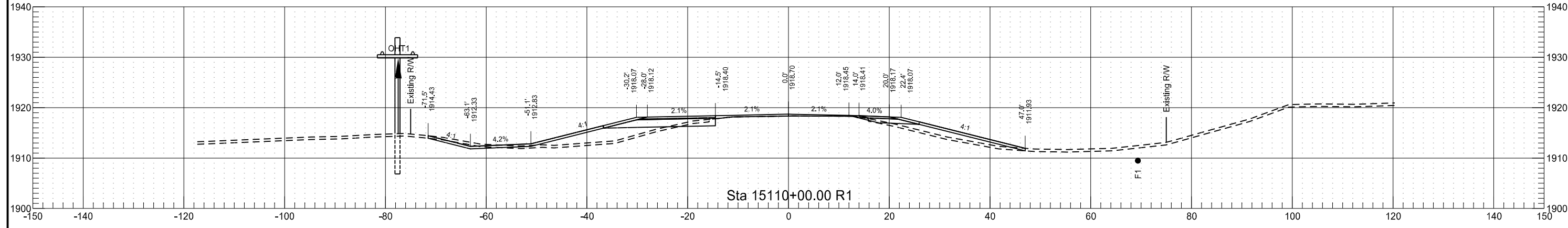
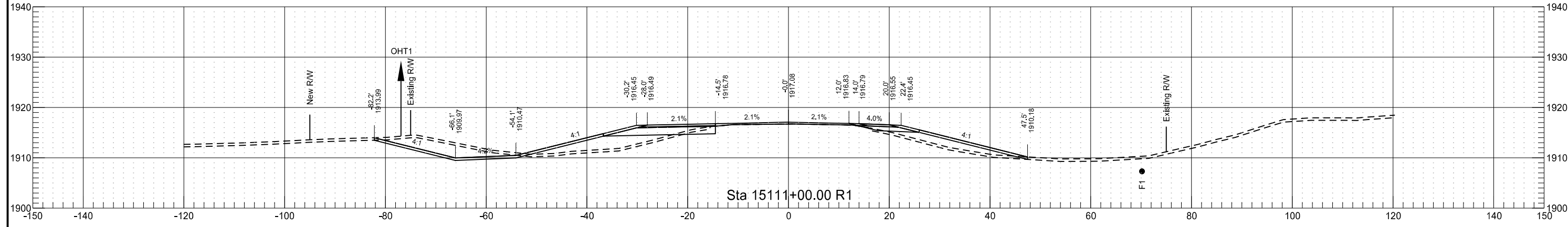
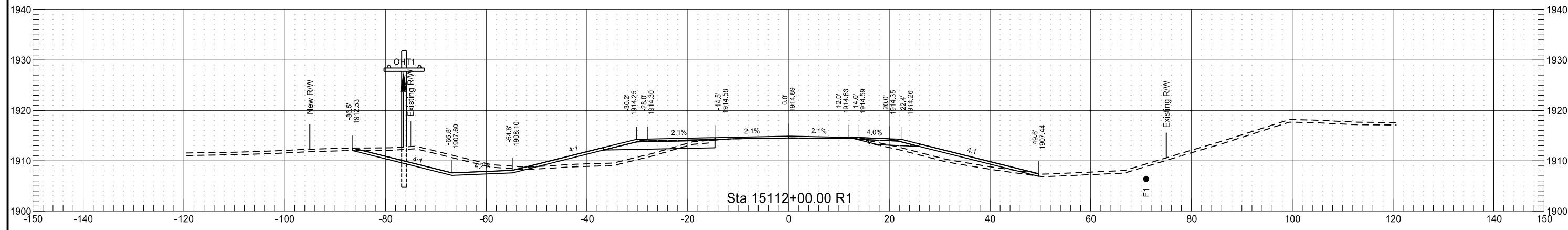

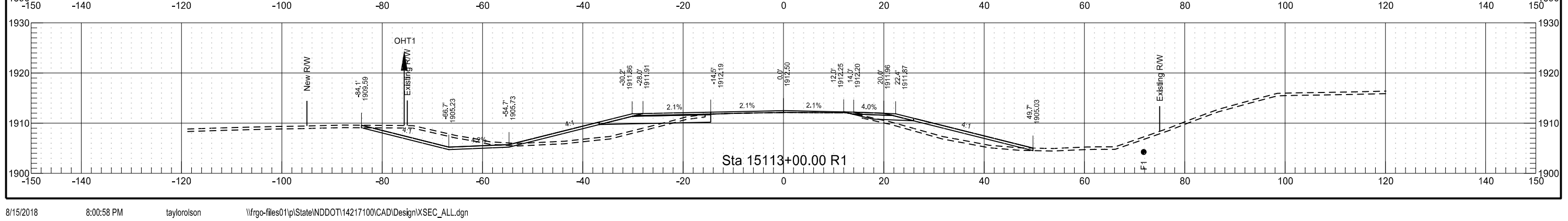
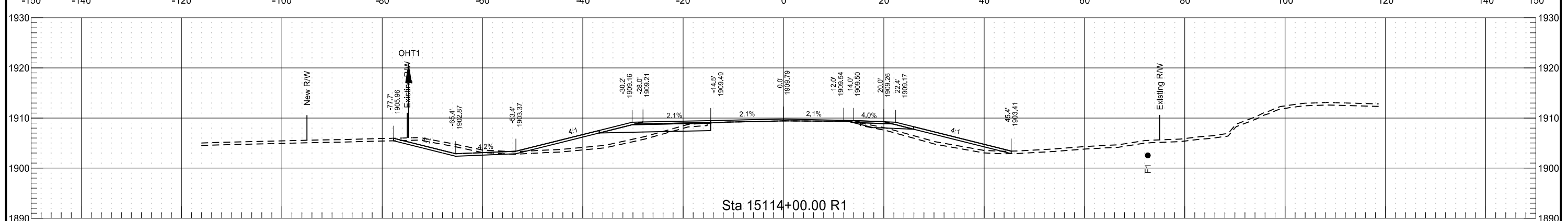
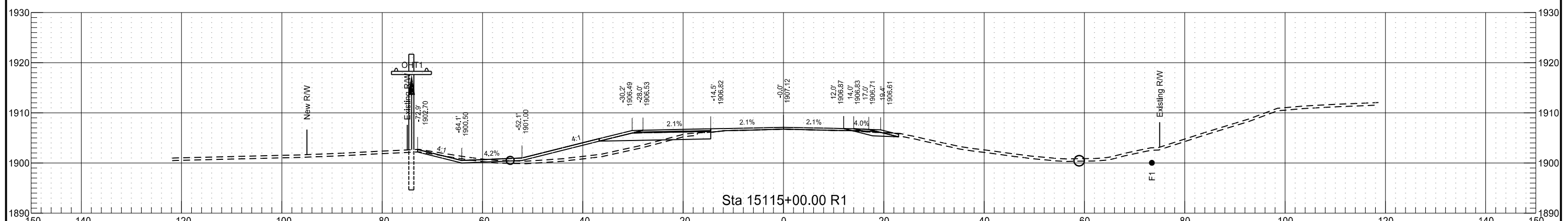
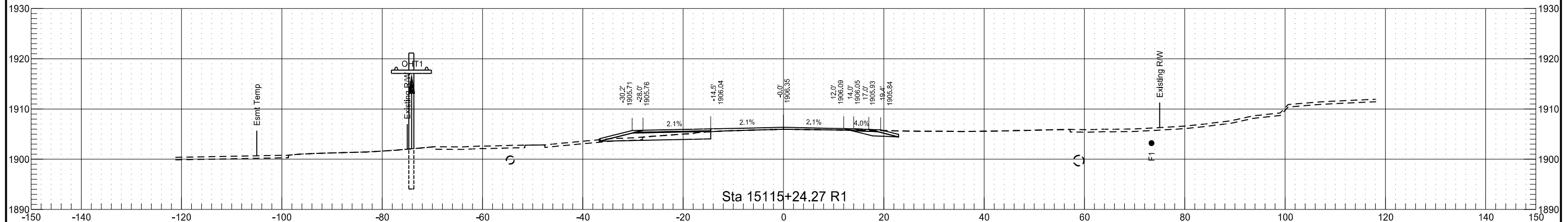

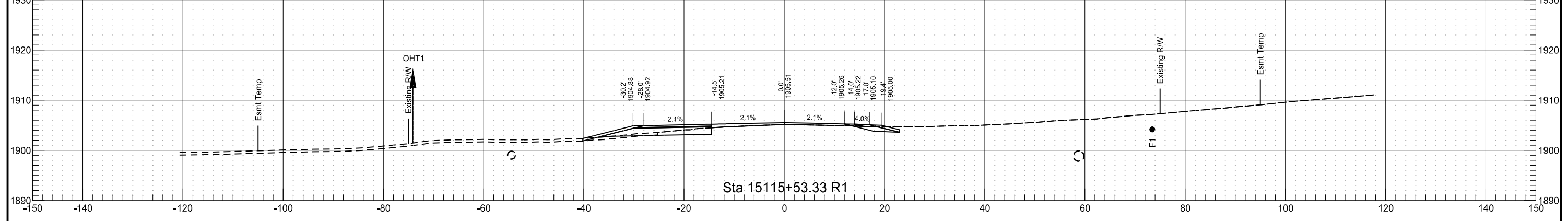
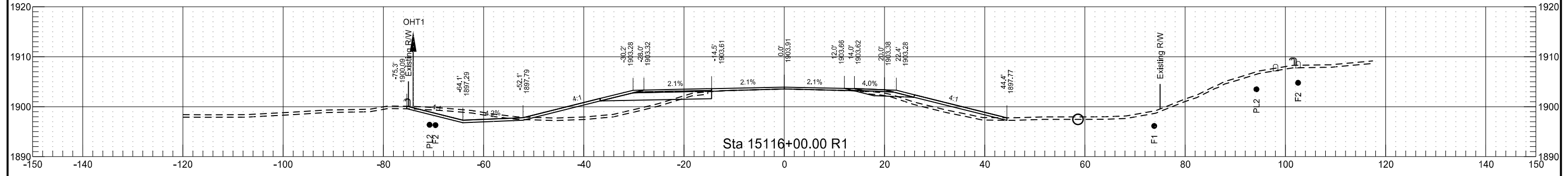
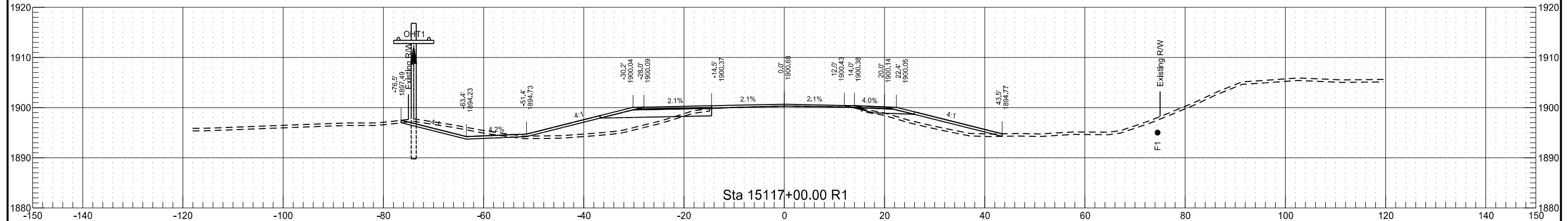
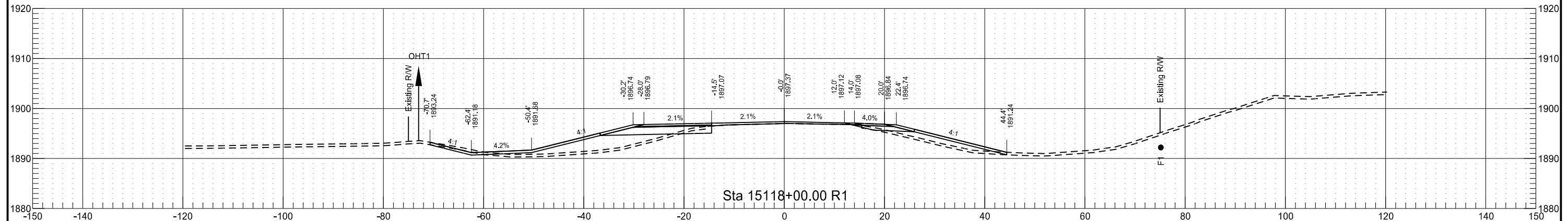

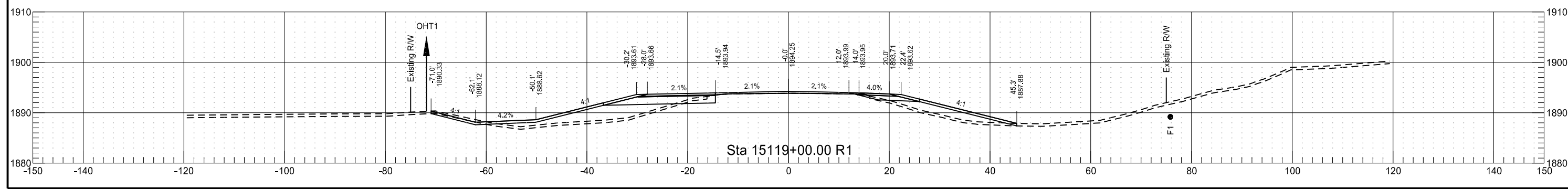
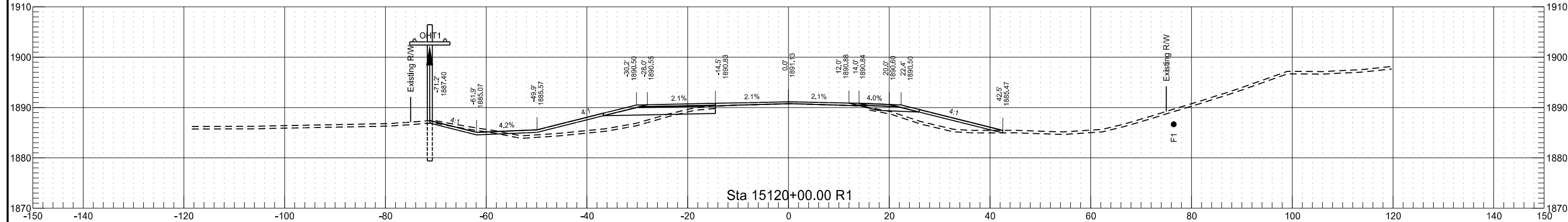
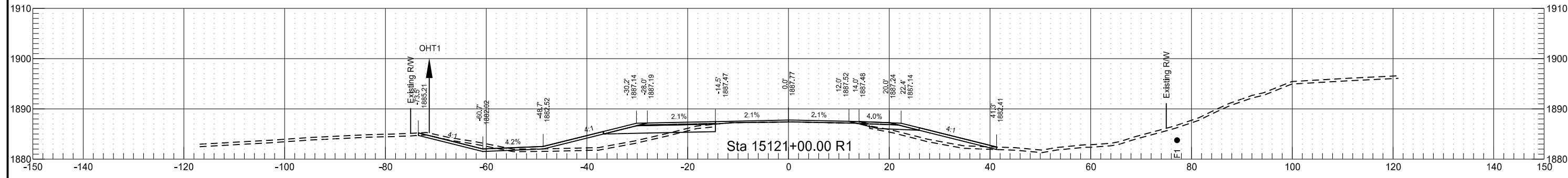
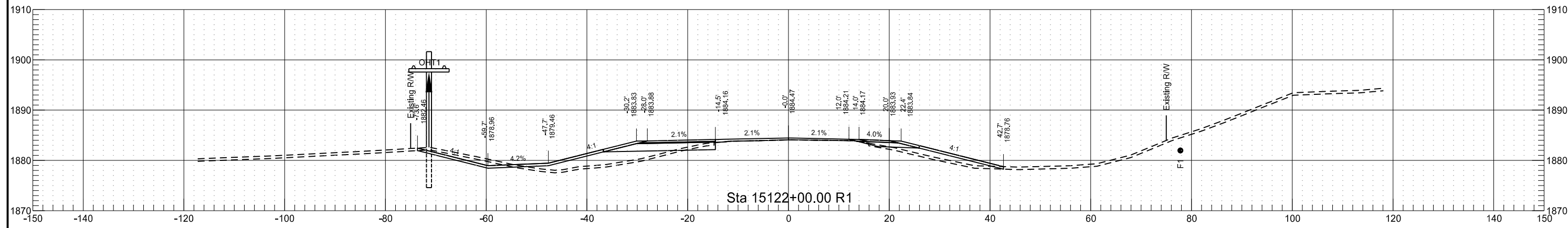

STATE	PROJECT NO.	SECTION NO.	SHEET NO.
ND	SOIB-7-804(061)283	200	55

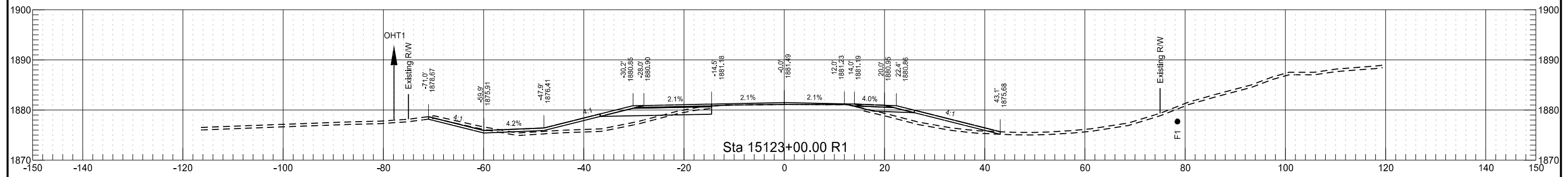
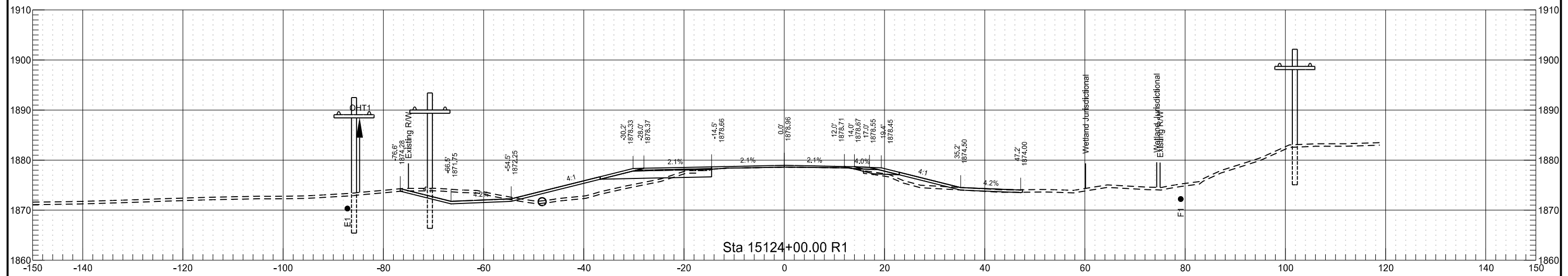
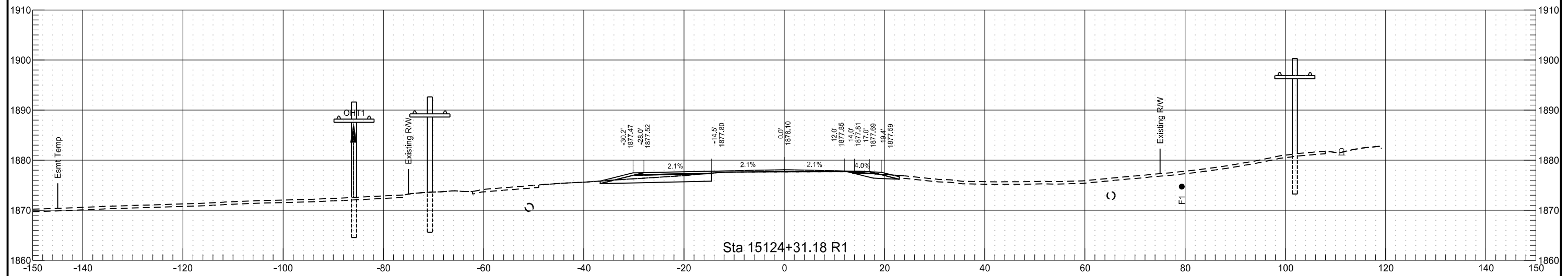

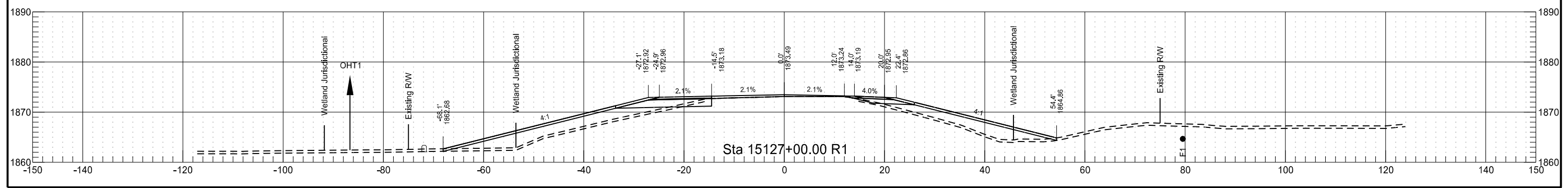
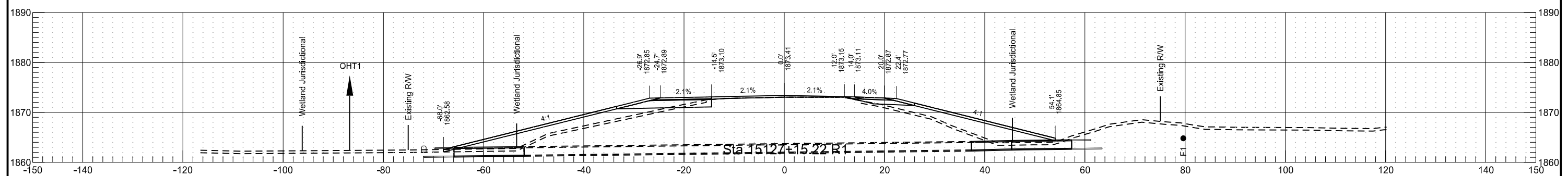
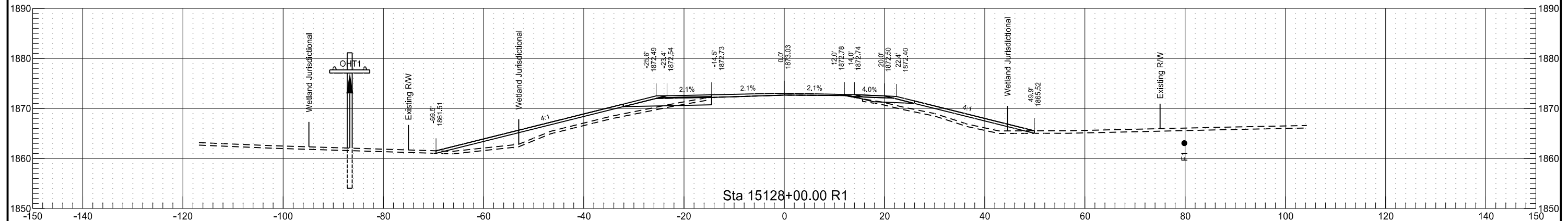
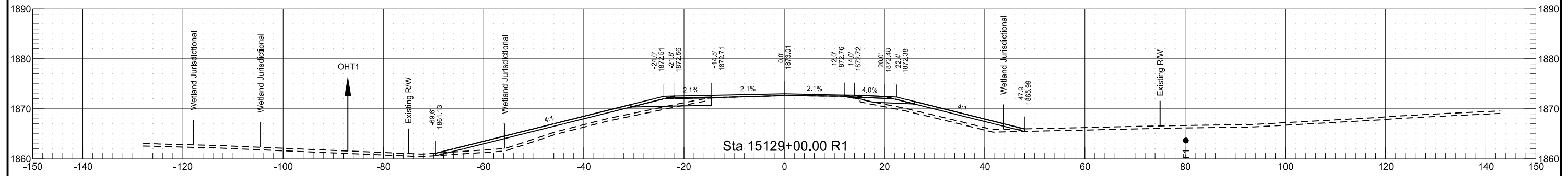
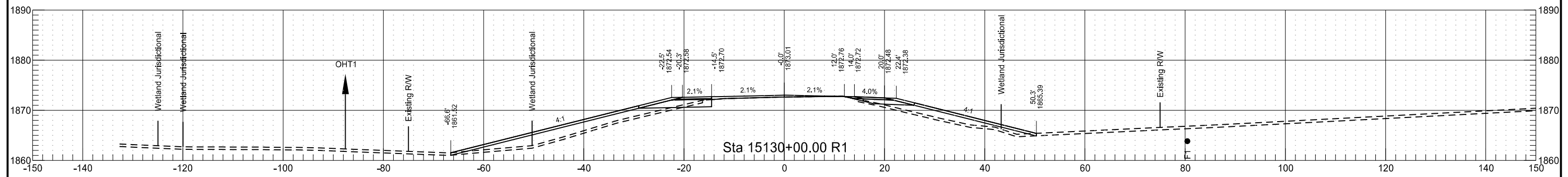

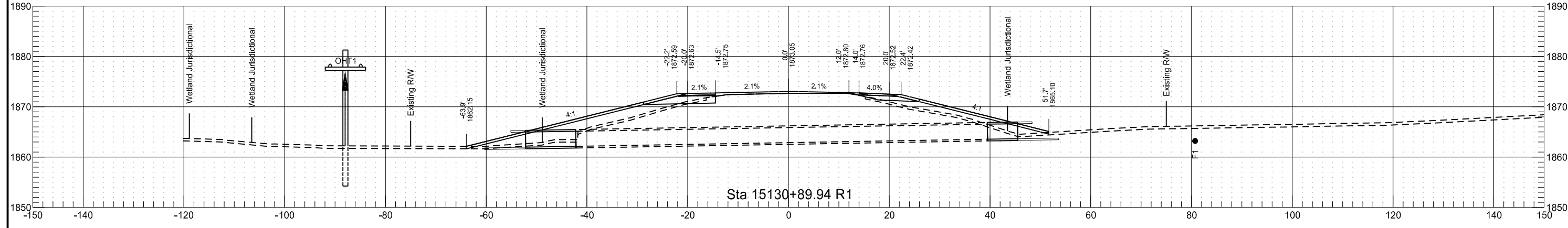
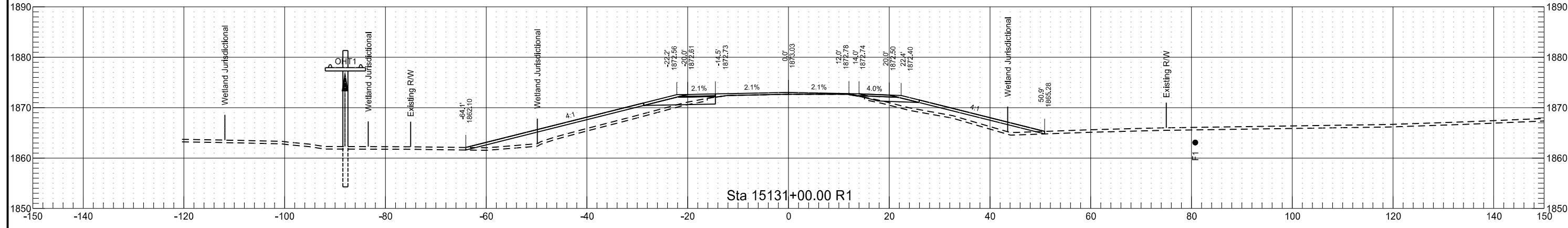
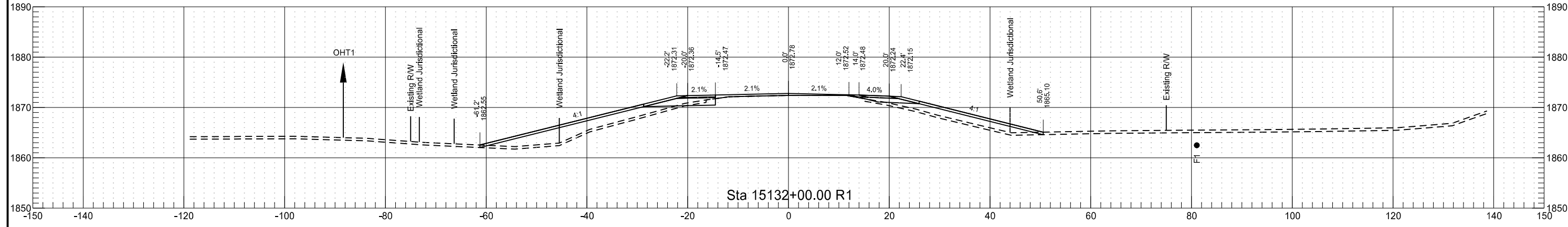
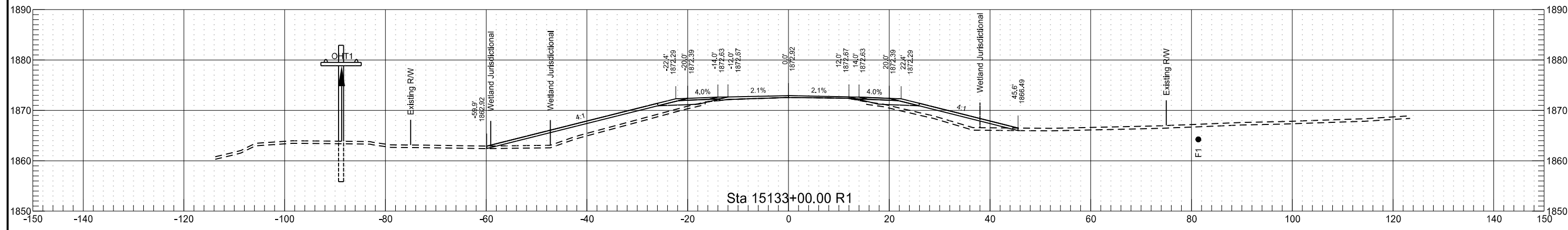

STATE	PROJECT NO.	SECTION NO.	SHEET NO.
ND	SOIB-7-804(061)283	200	59

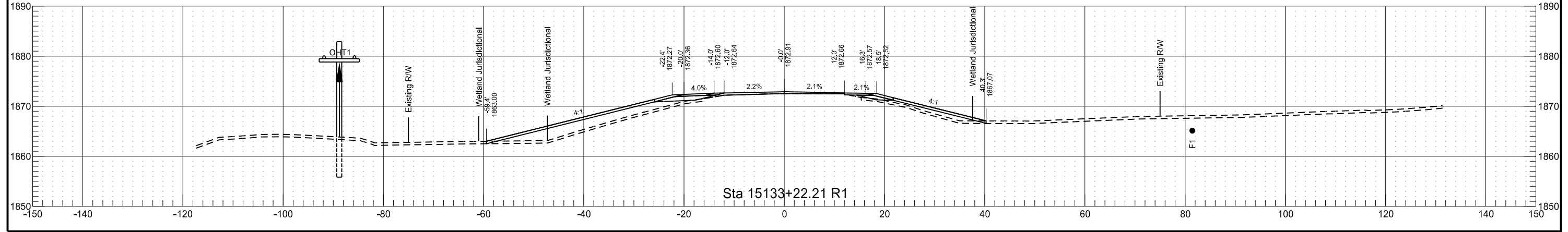
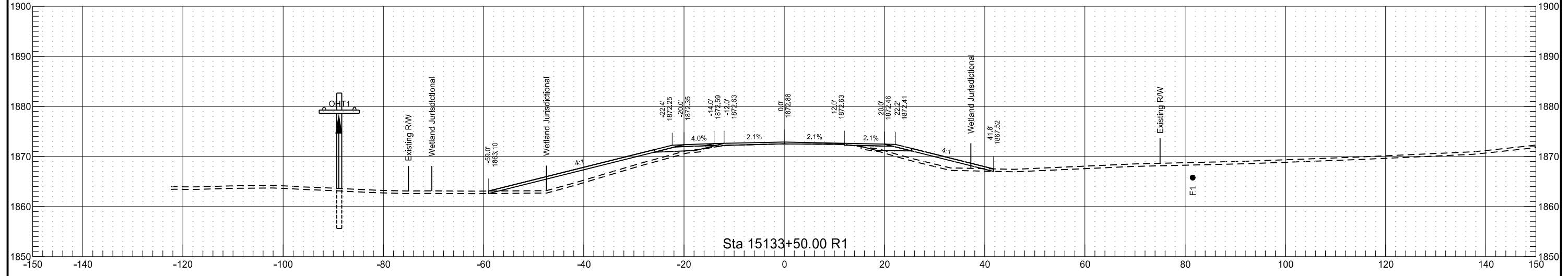
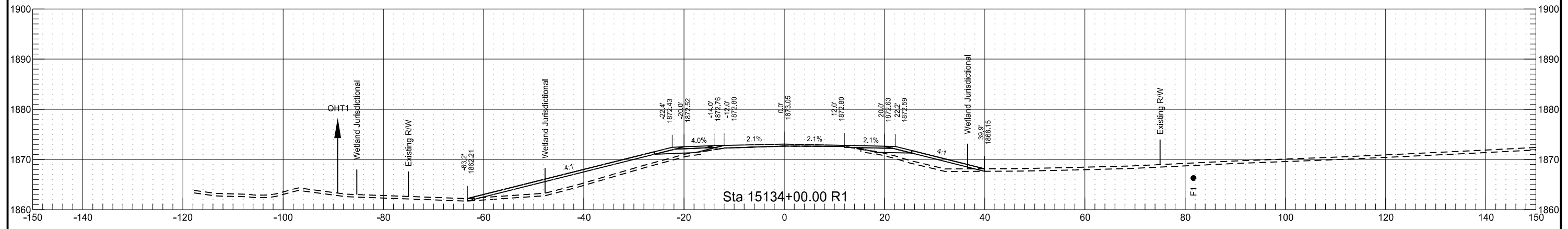

STATE	PROJECT NO.	SECTION NO.	SHEET NO.
ND	SOIB-7-804(061)283	200	60

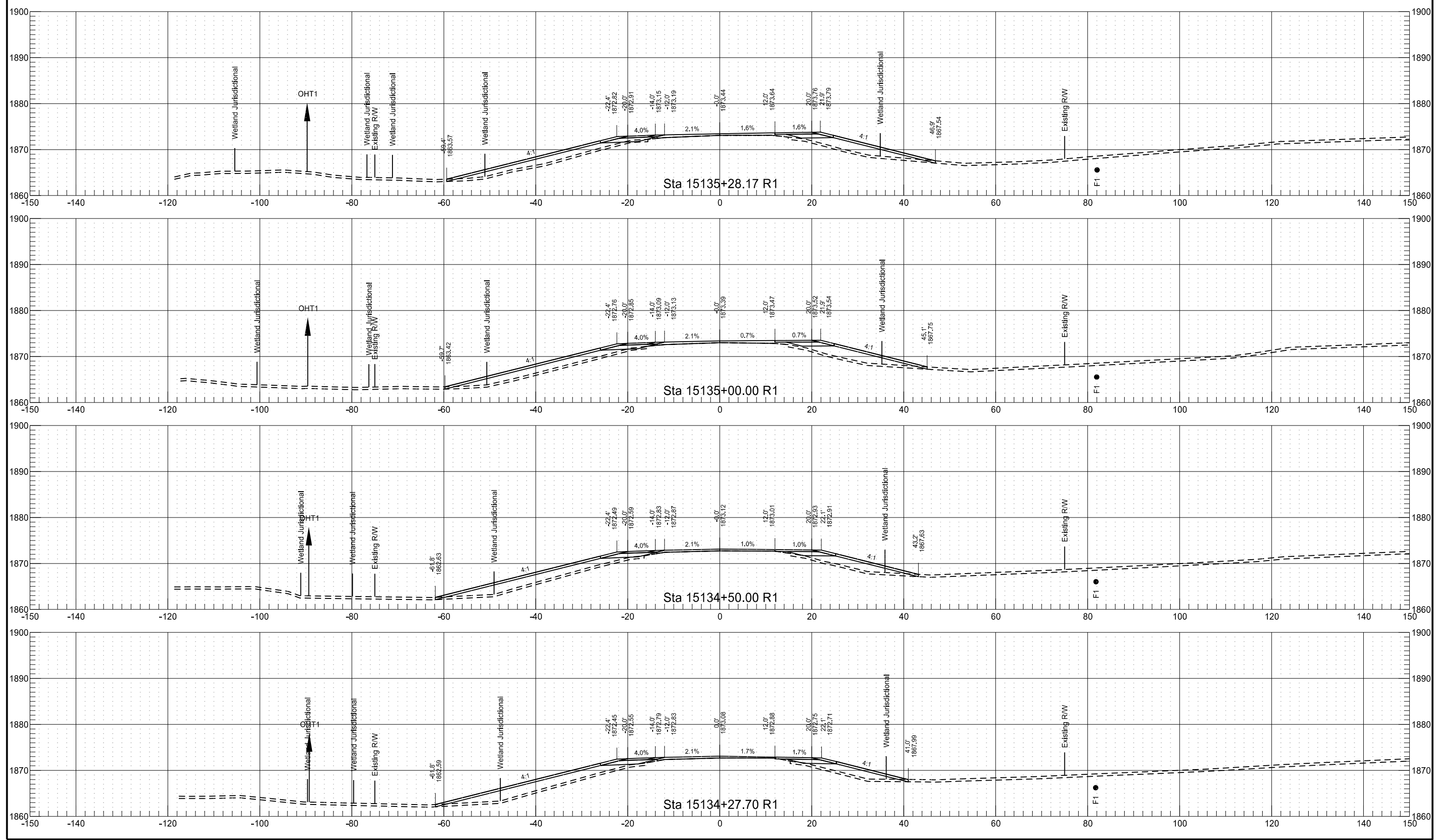

STATE	PROJECT NO.	SECTION NO.	SHEET NO.
ND	SOIB-7-804(061)283	200	61

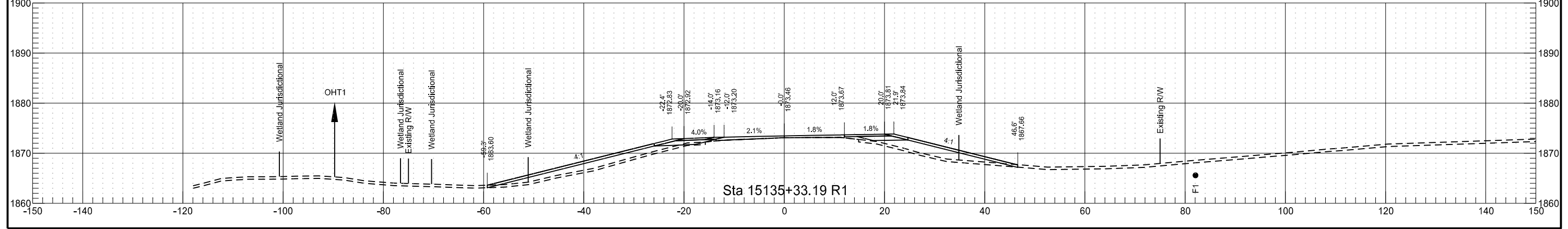
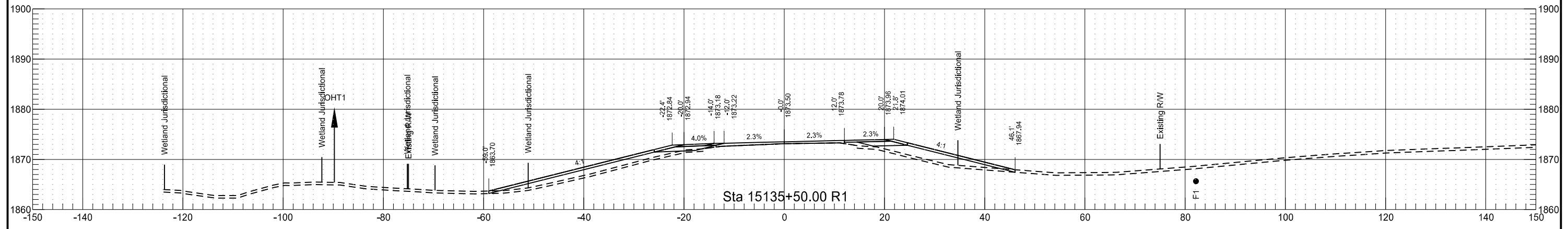
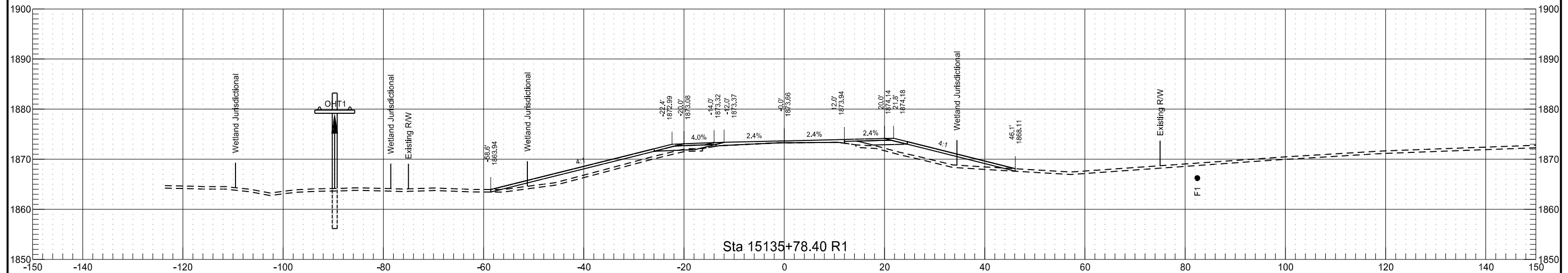

STATE	PROJECT NO.	SECTION NO.	SHEET NO.
ND	SOIB-7-804(061)283	200	62

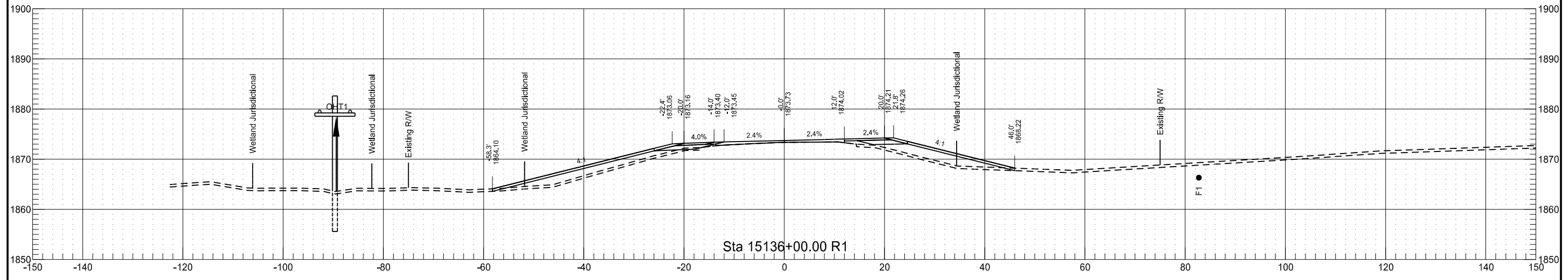
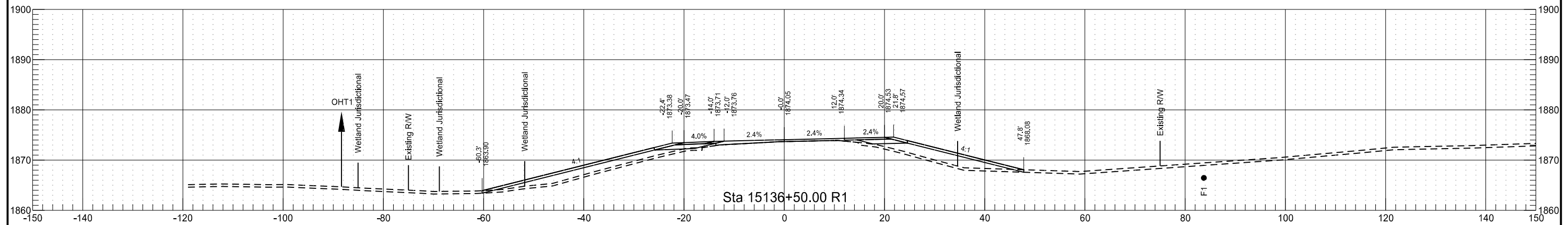
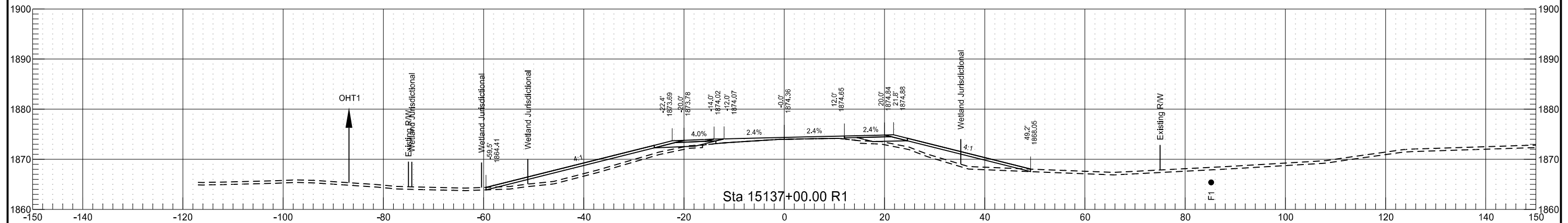

STATE	PROJECT NO.	SECTION NO.	SHEET NO.
ND	SOIB-7-804(061)283	200	63

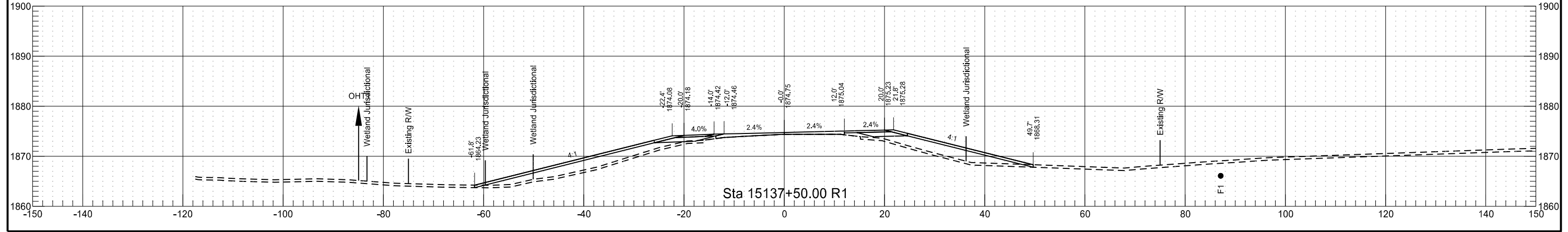
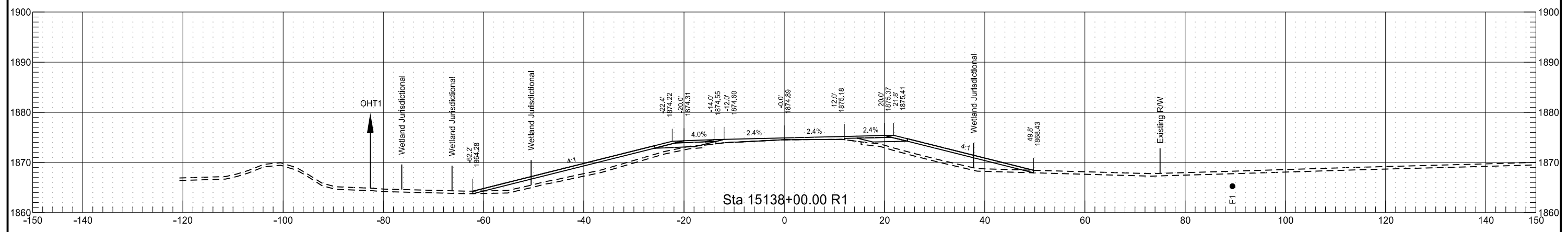
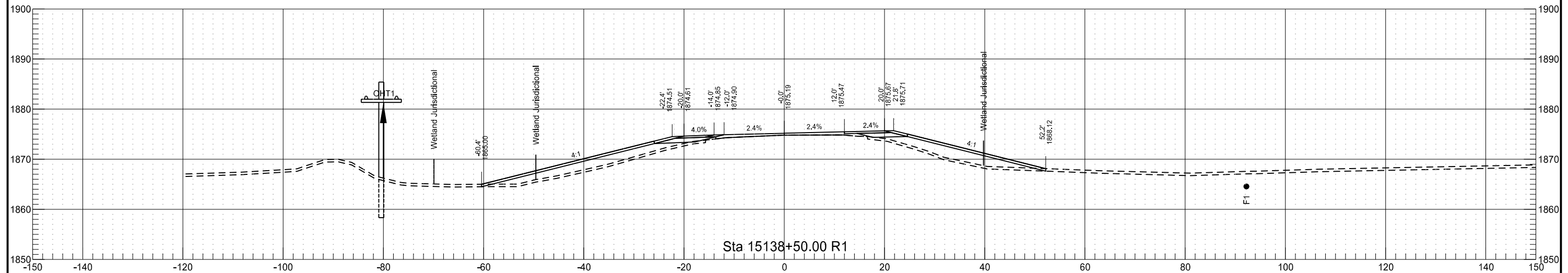

	STATE	PROJECT NO.	SECTION NO.	SHEET NO.
	ND	SOIB-7-804(061)283	200	64

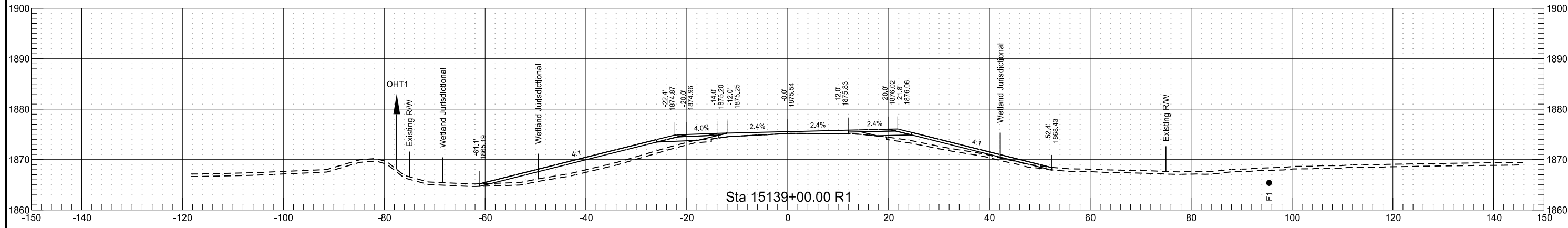
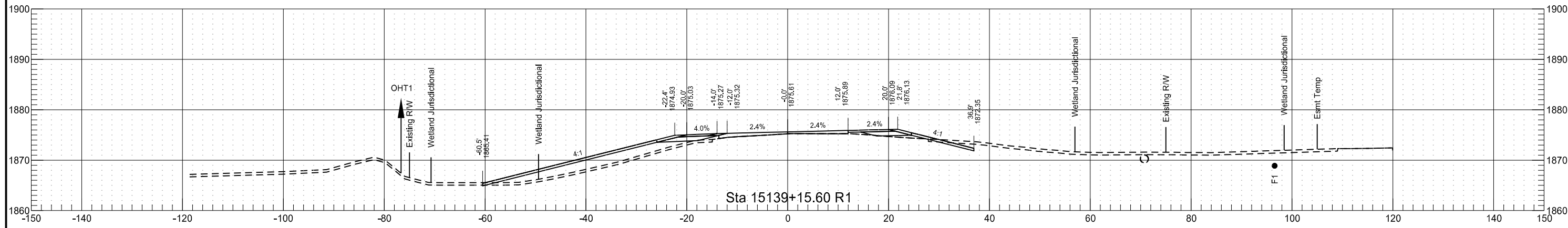
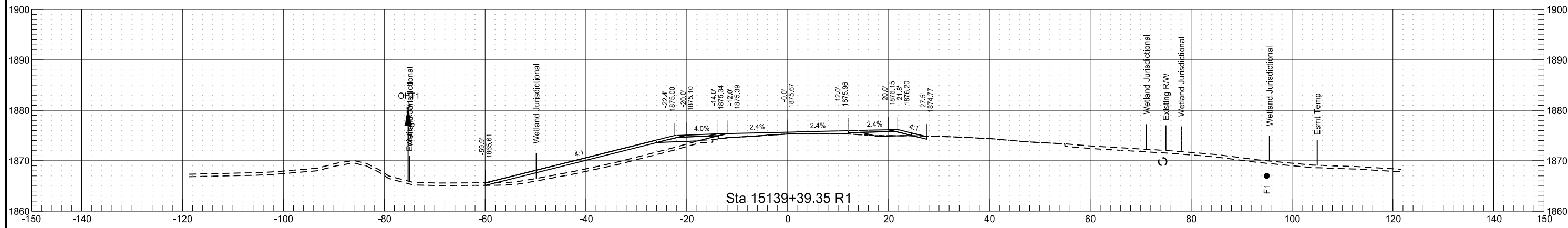
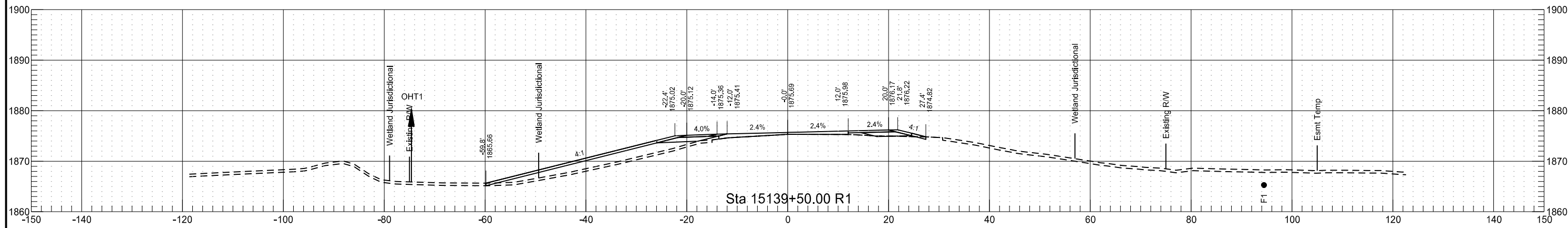

STATE	PROJECT NO.	SECTION NO.	SHEET NO.
ND	SOIB-7-804(061)283	200	65

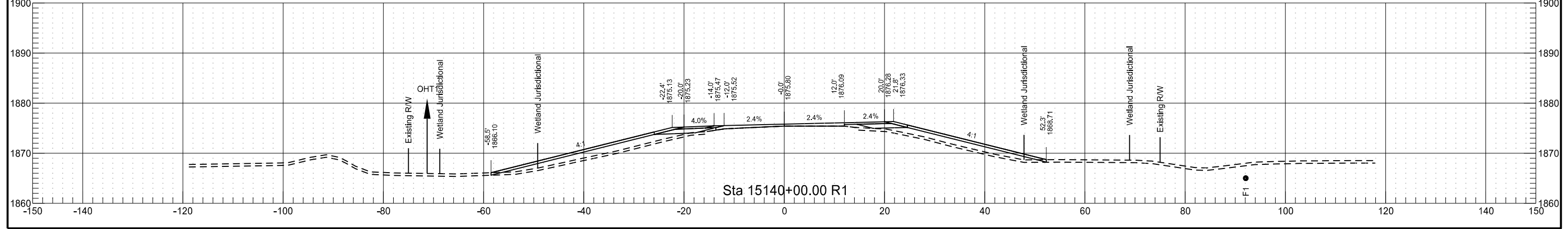
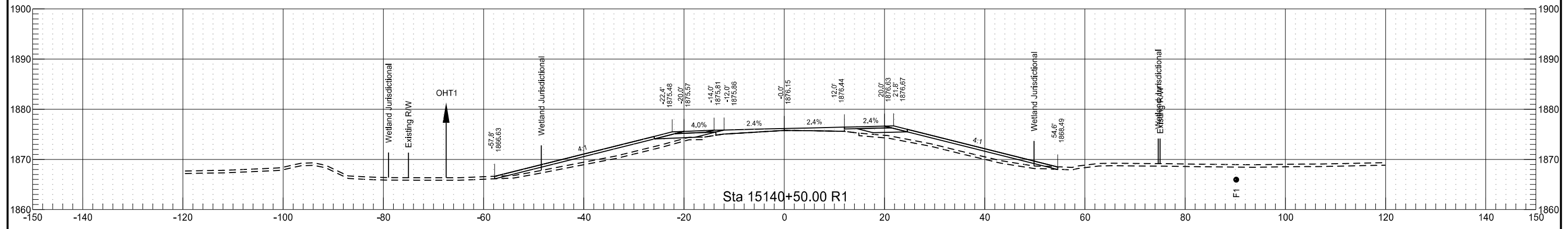
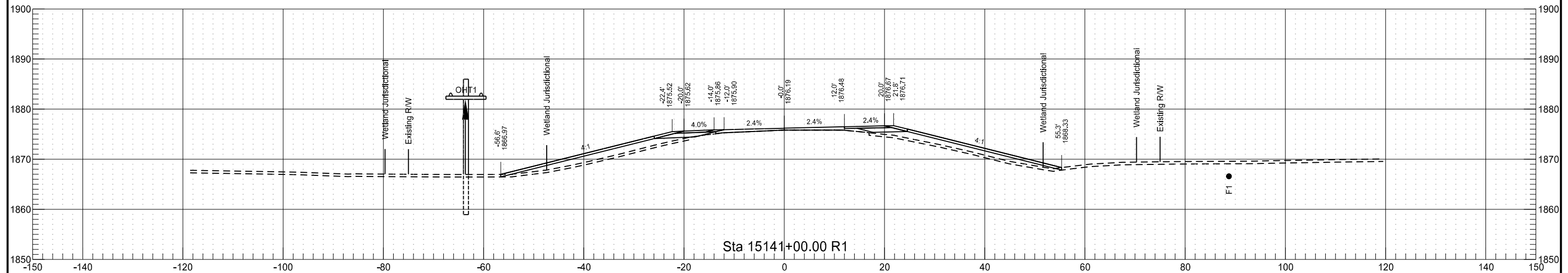

STATE	PROJECT NO.	SECTION NO.	SHEET NO.
ND	SOIB-7-804(061)283	200	66

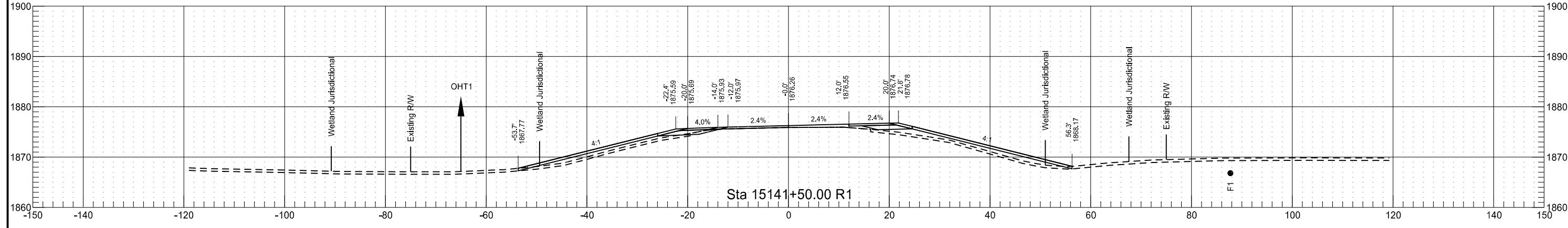
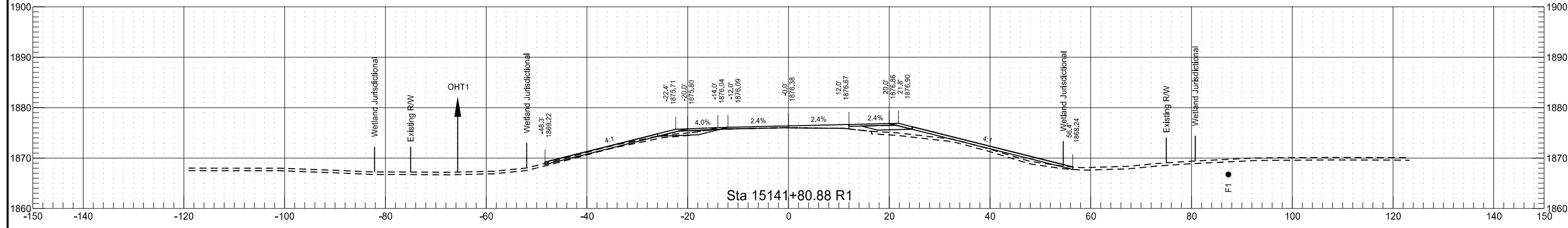
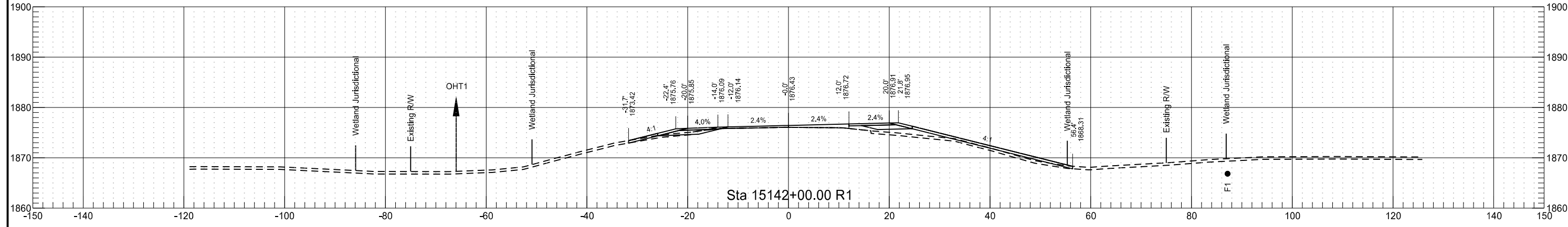
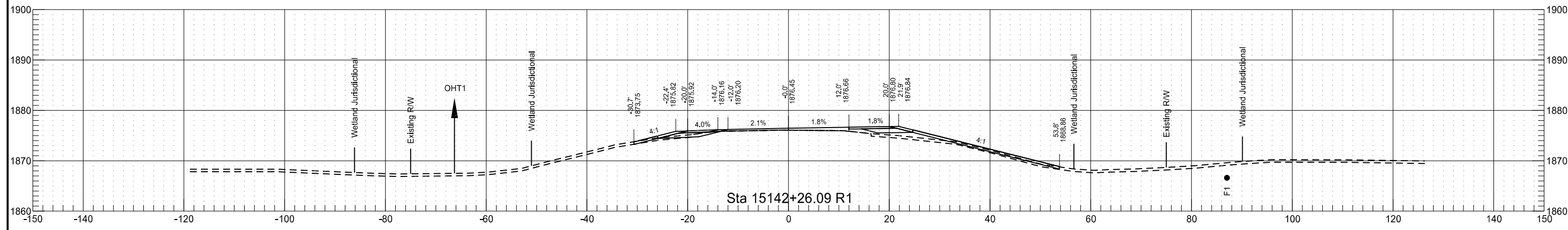

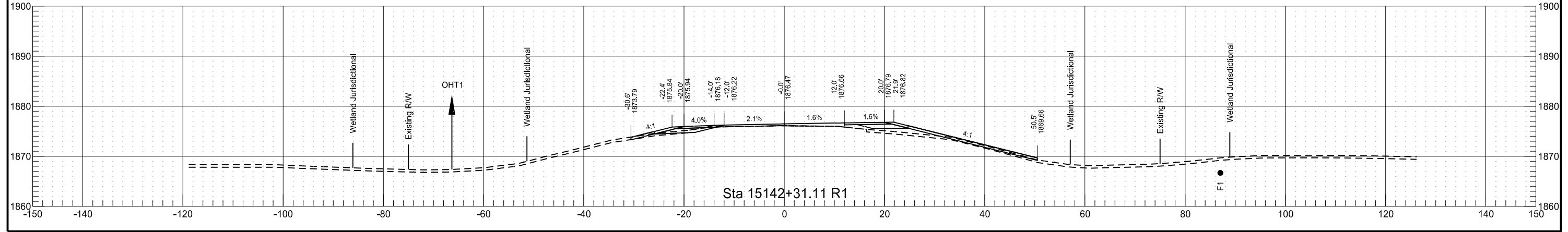
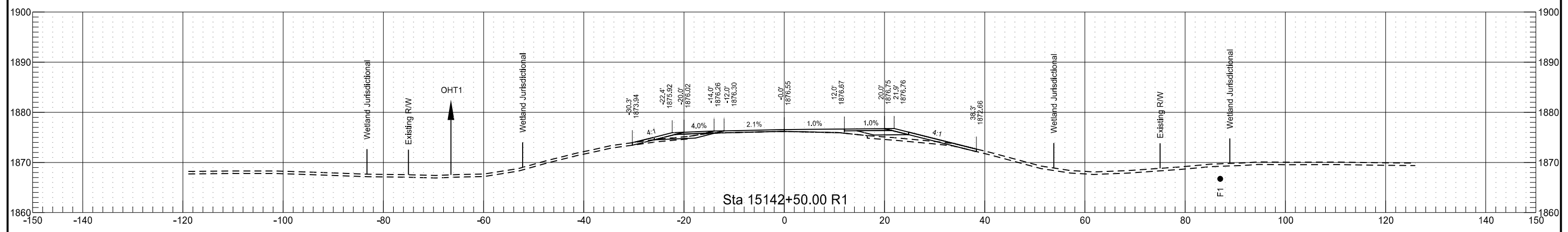
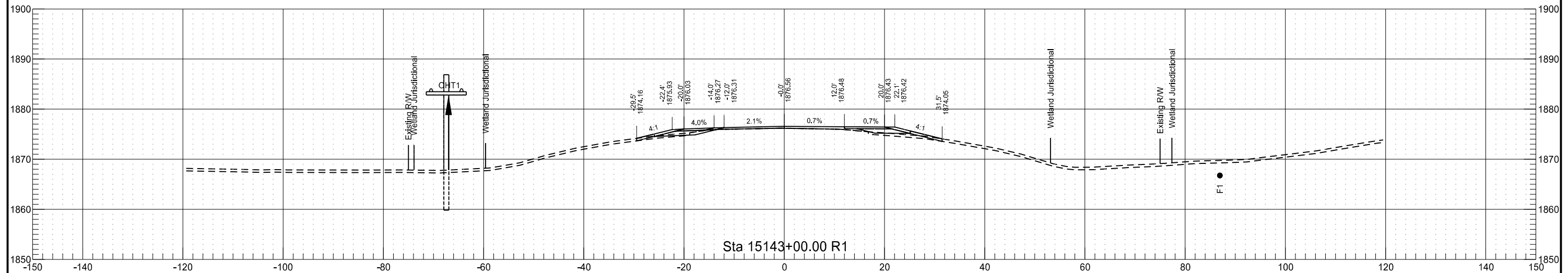

STATE	PROJECT NO.	SECTION NO.	SHEET NO.
ND	SOIB-7-804(061)283	200	68

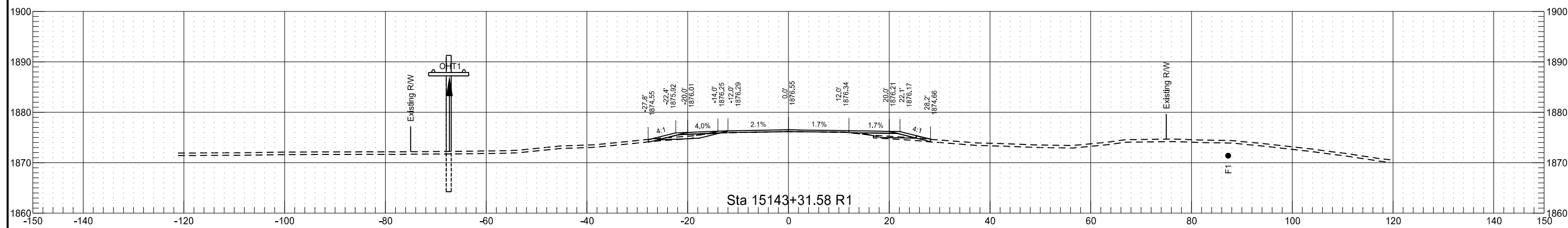
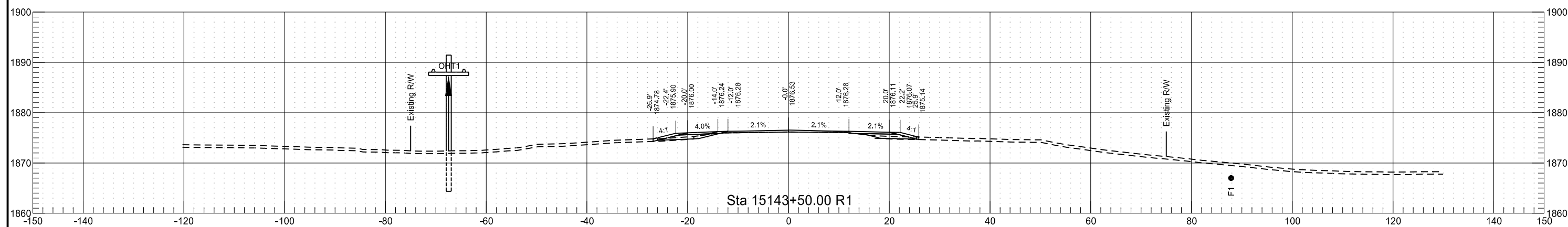
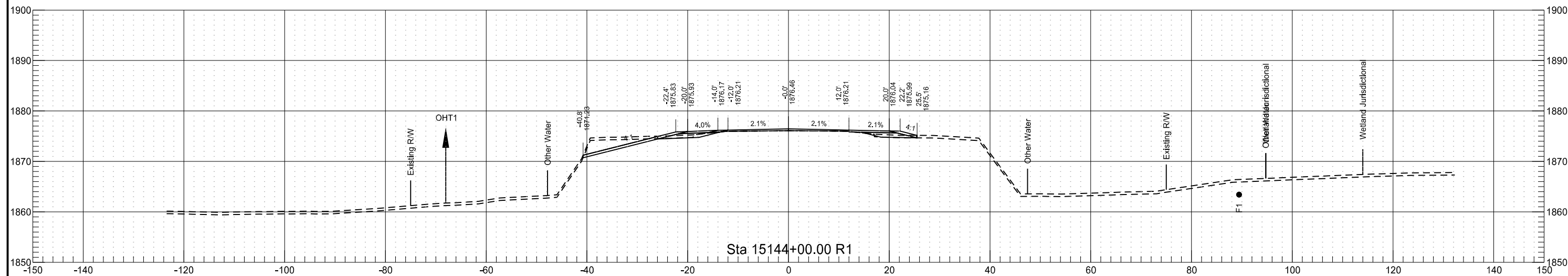

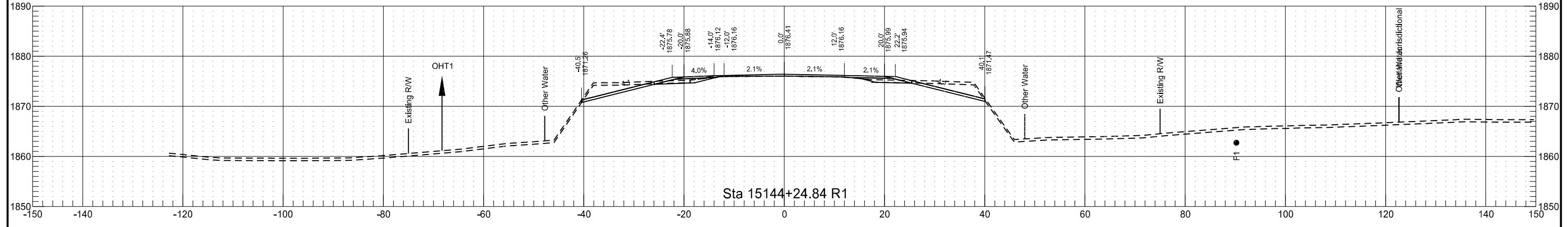
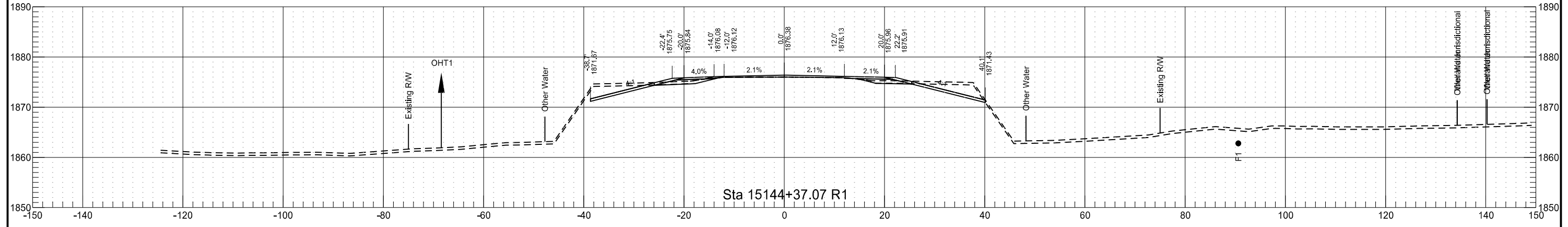
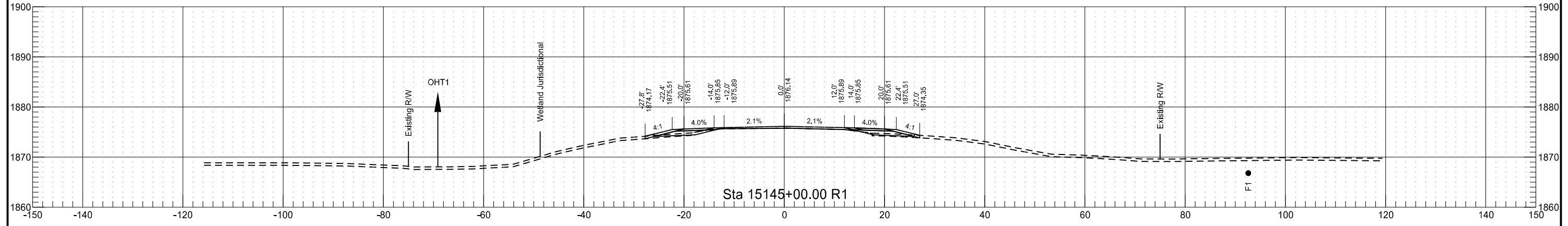
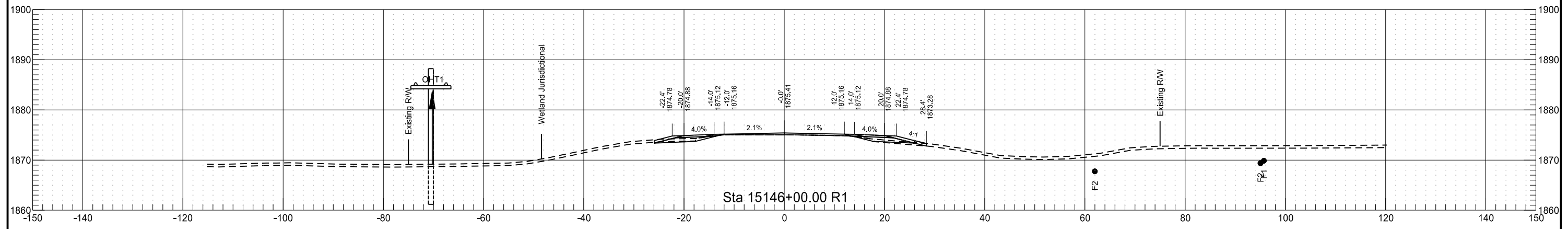

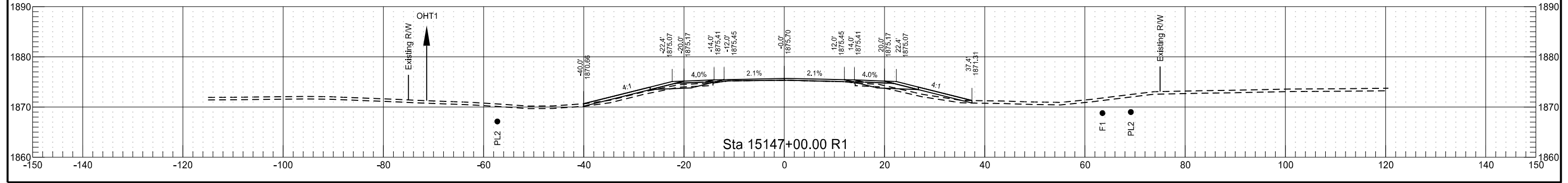
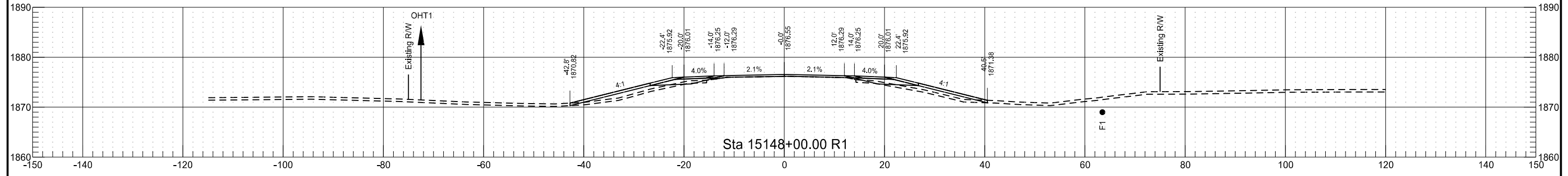
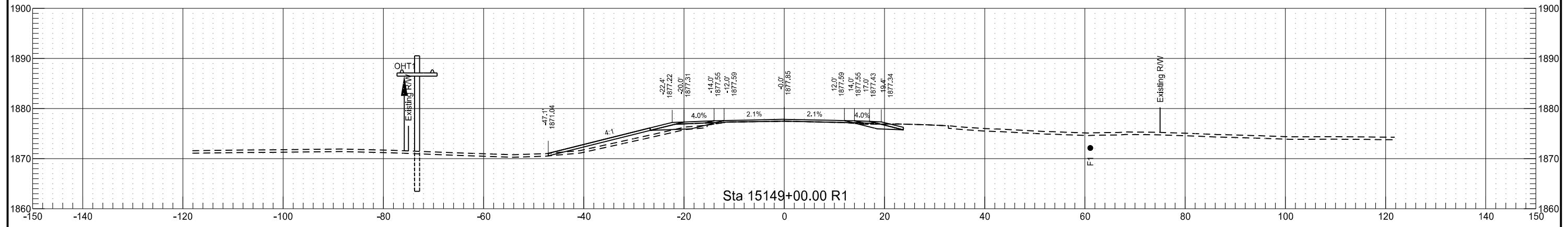
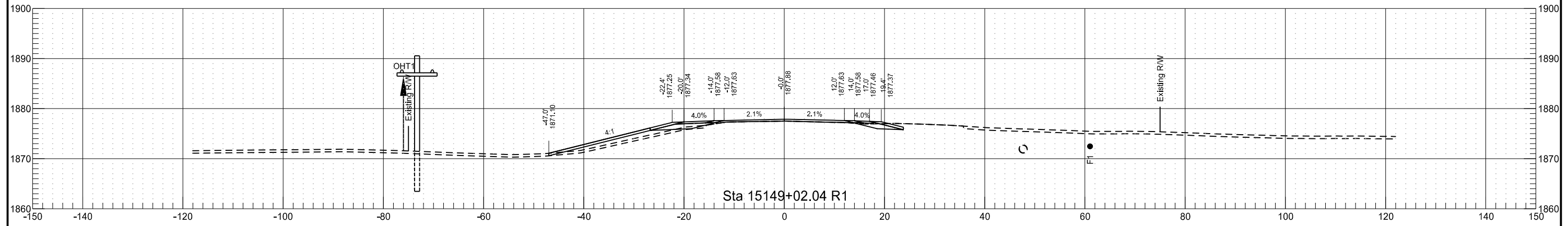

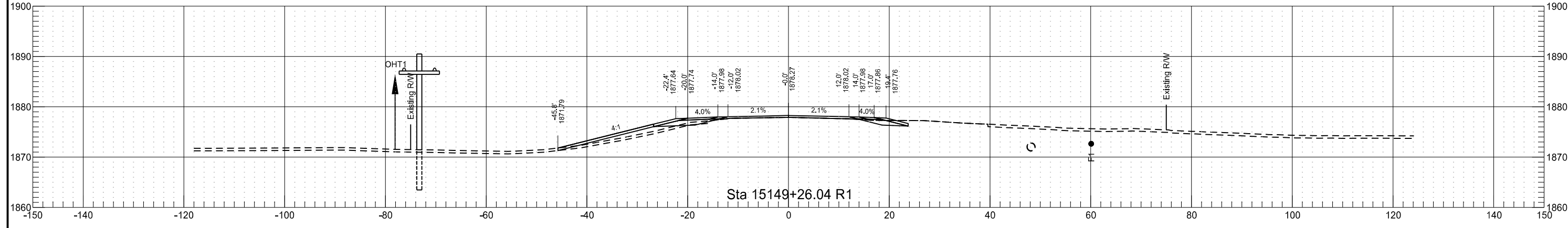
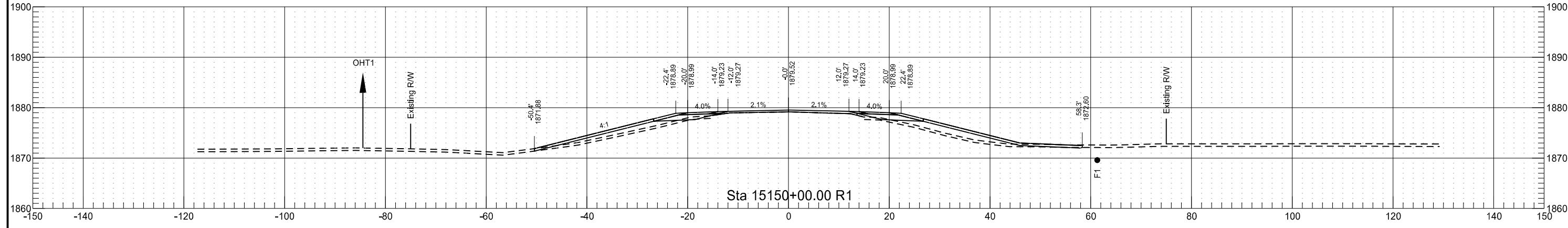
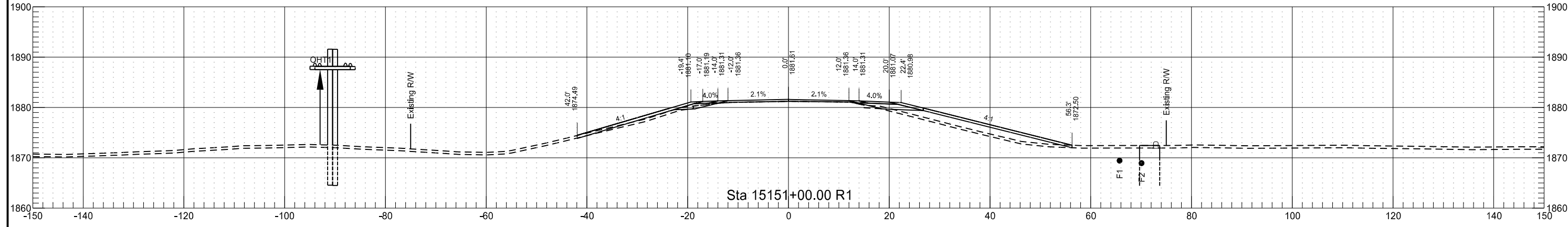
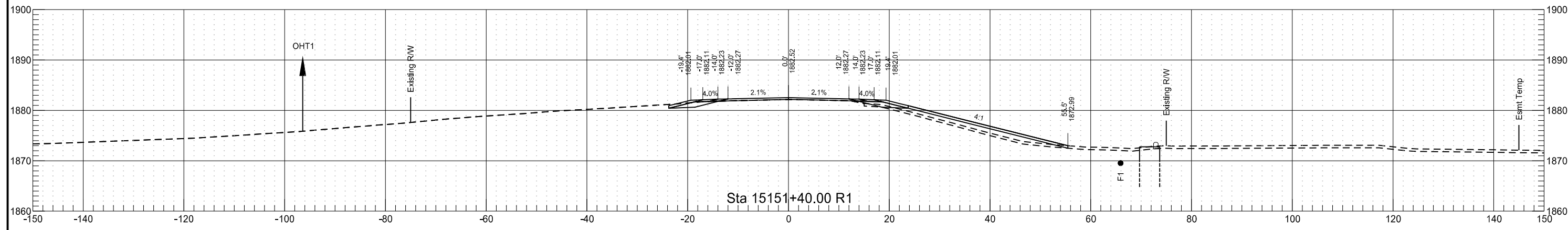

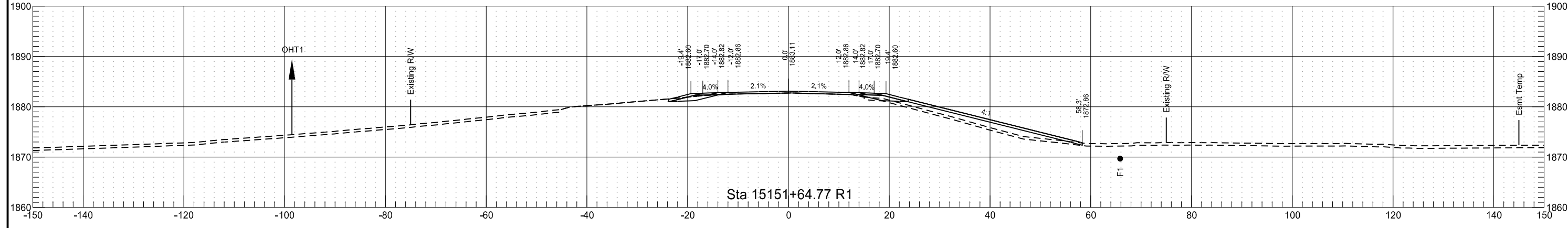
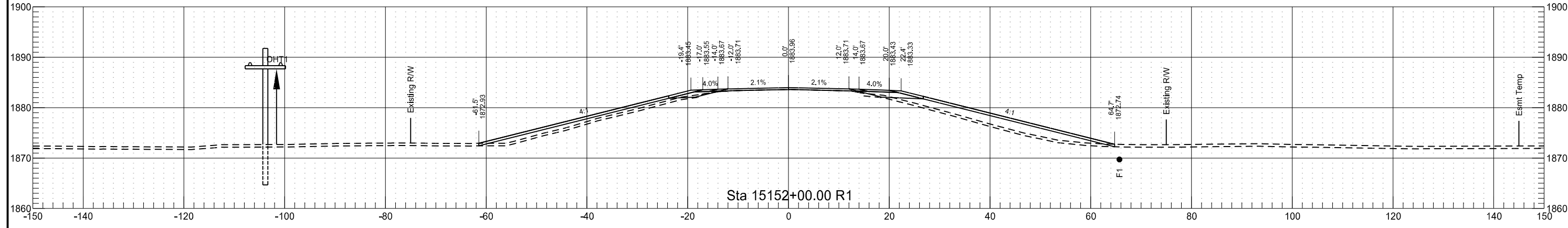
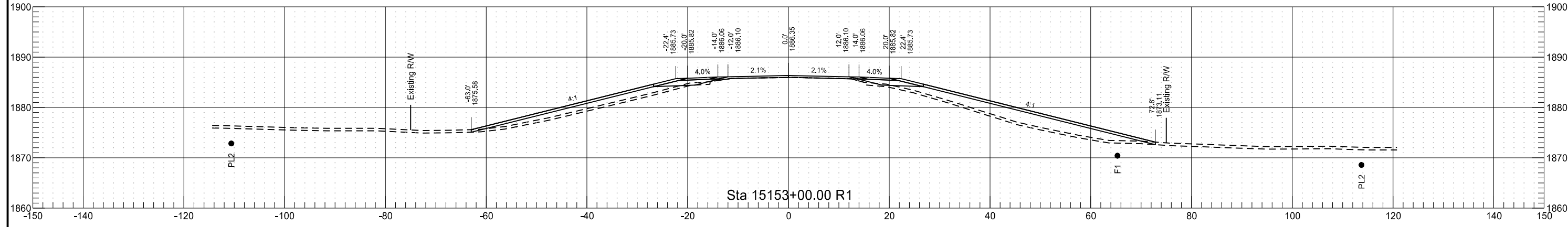
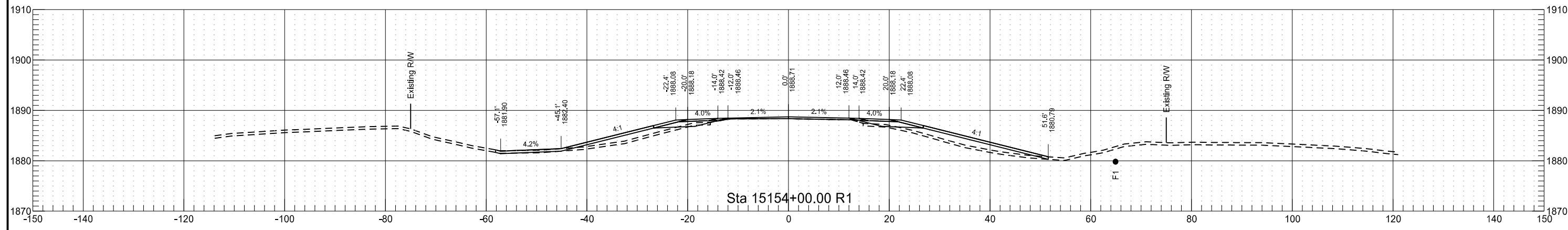

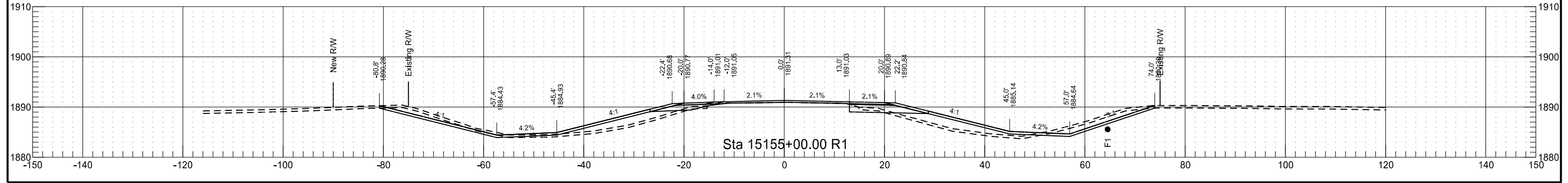
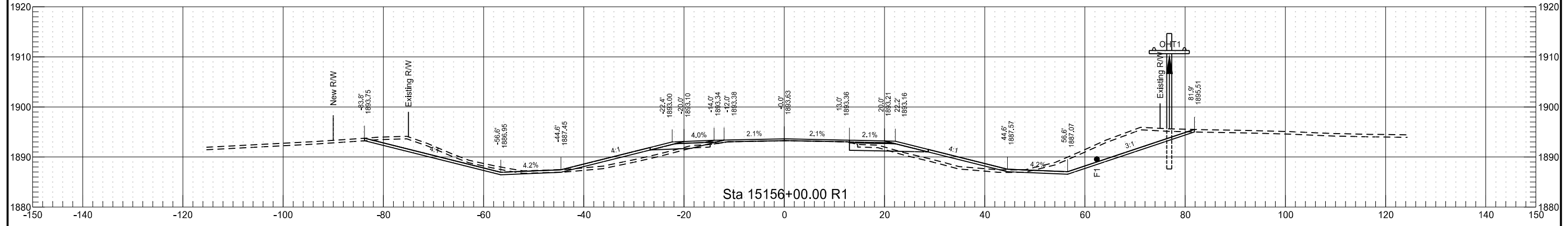
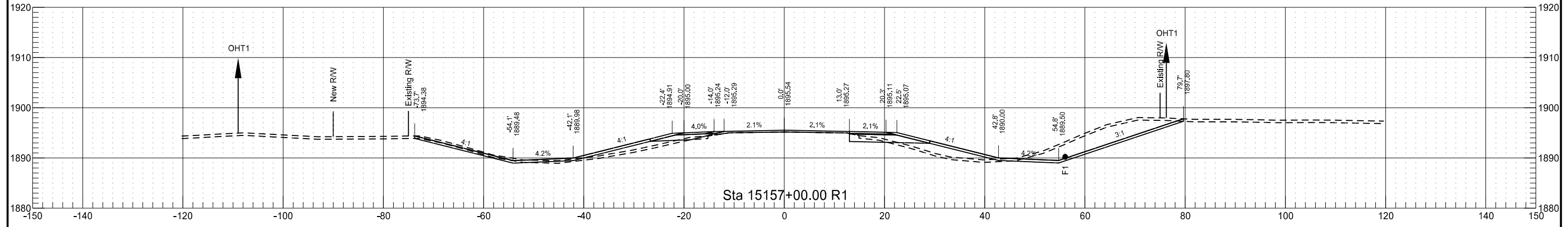
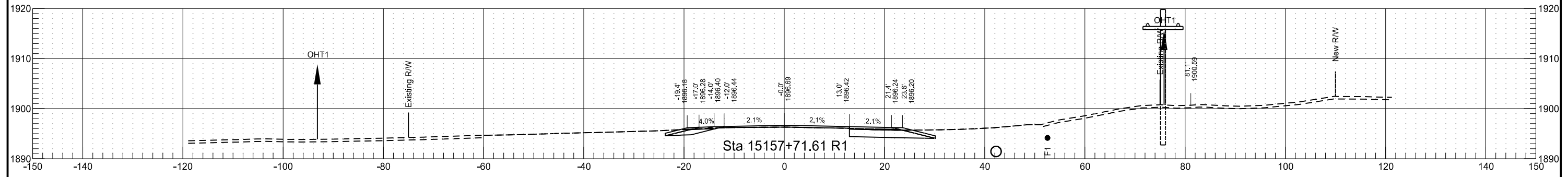

STATE	PROJECT NO.	SECTION NO.	SHEET NO.
ND	SOIB-7-804(061)283	200	74

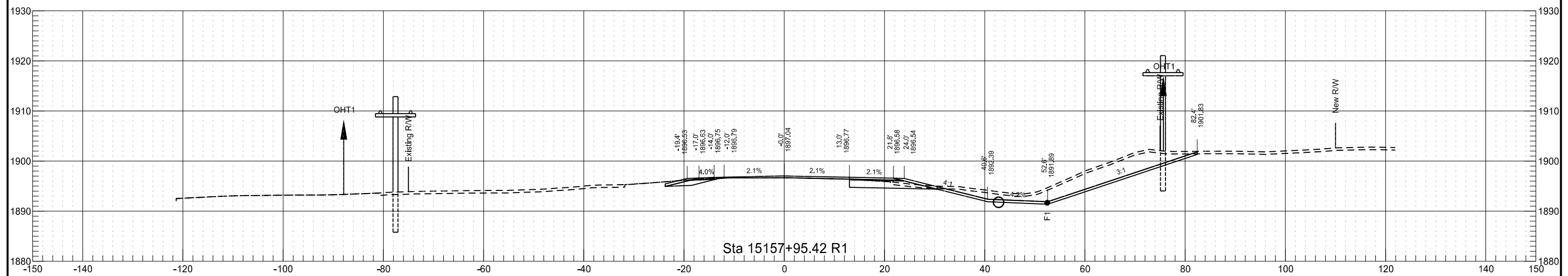
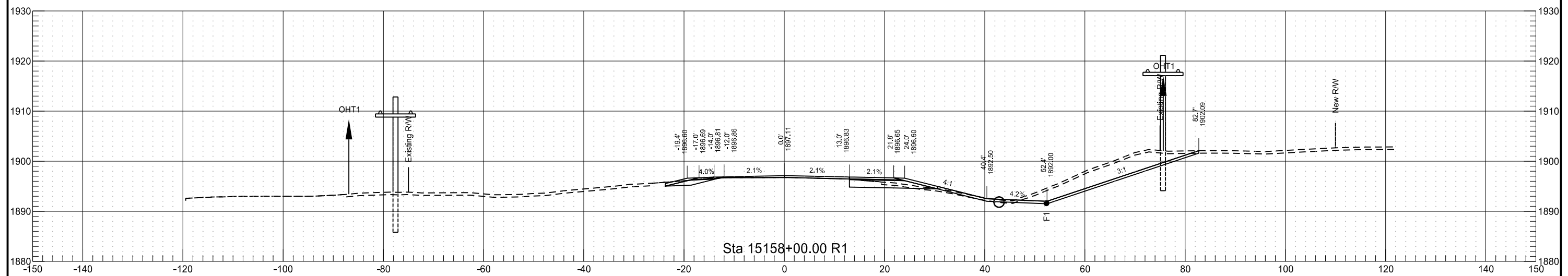
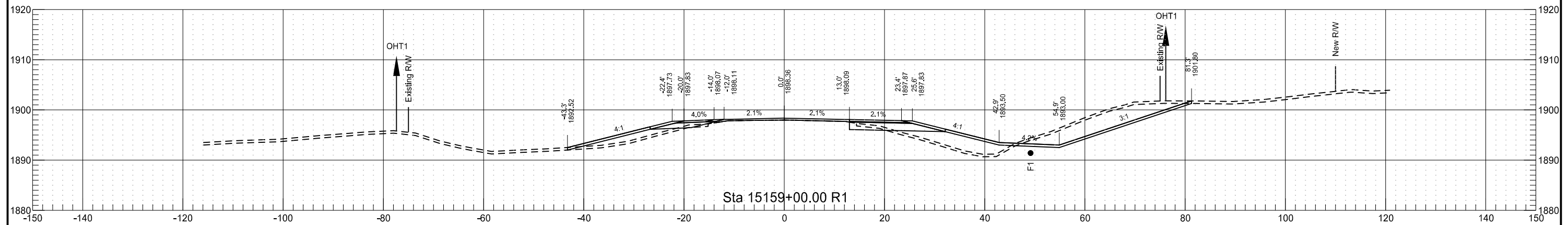

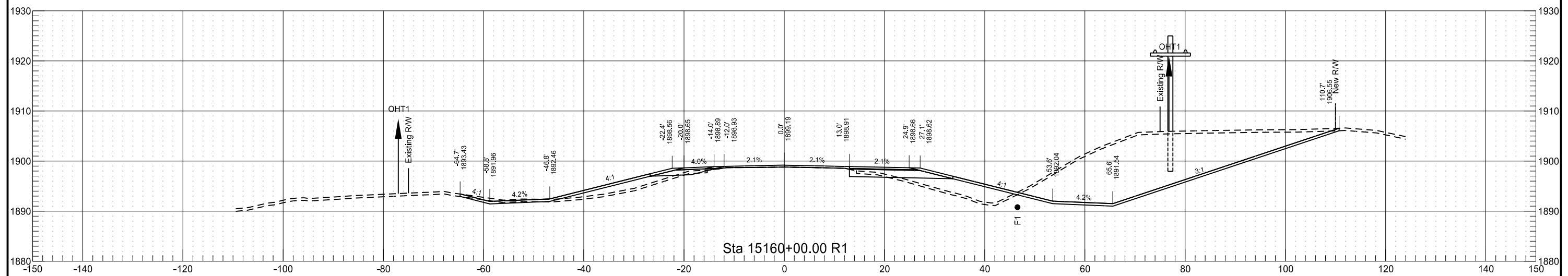
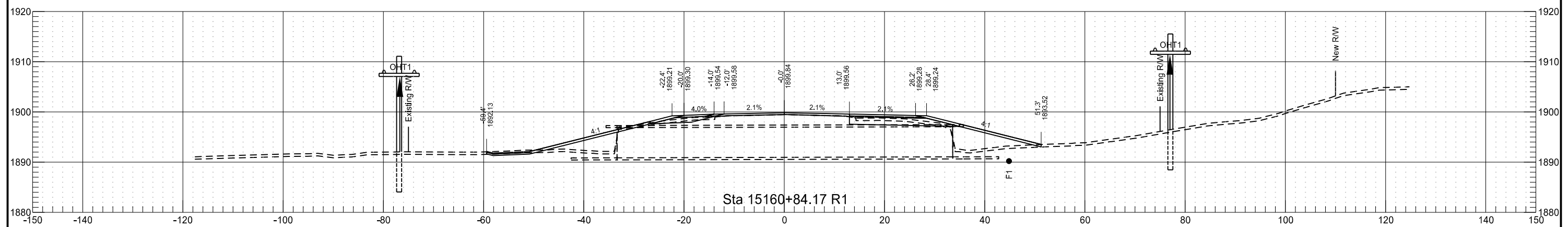
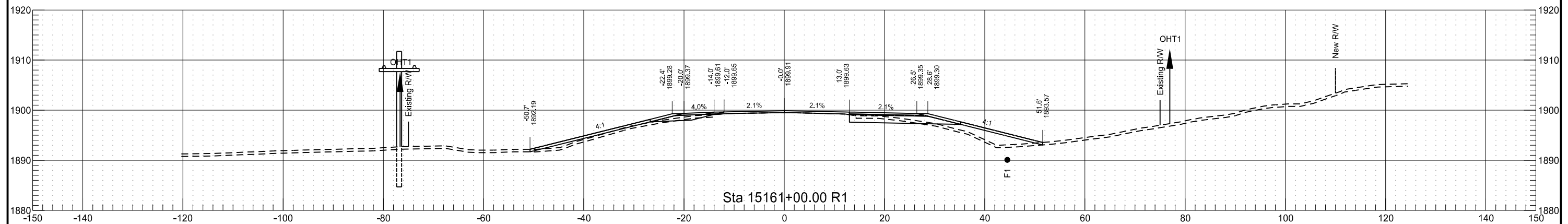

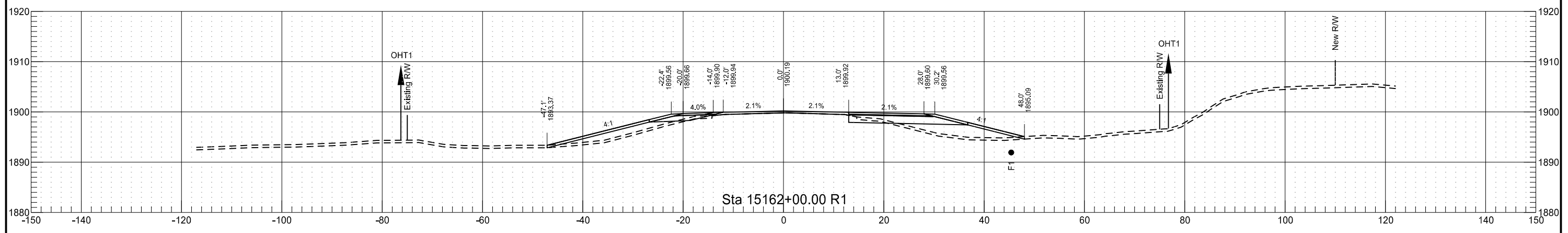
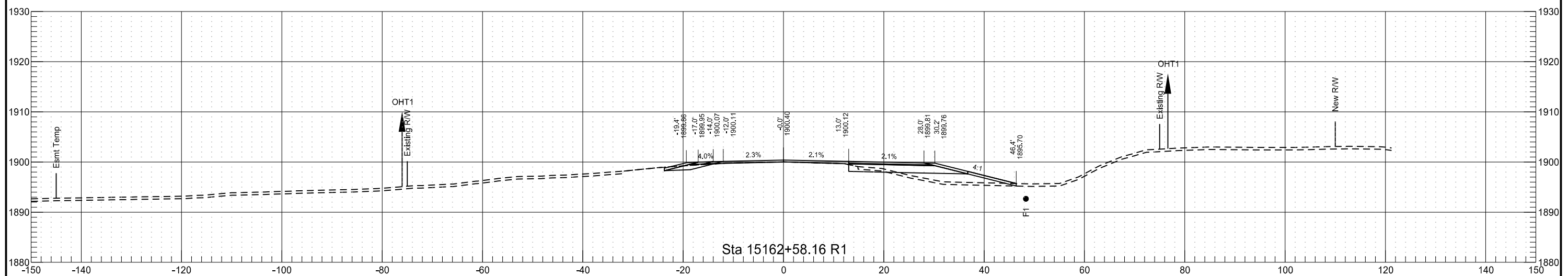
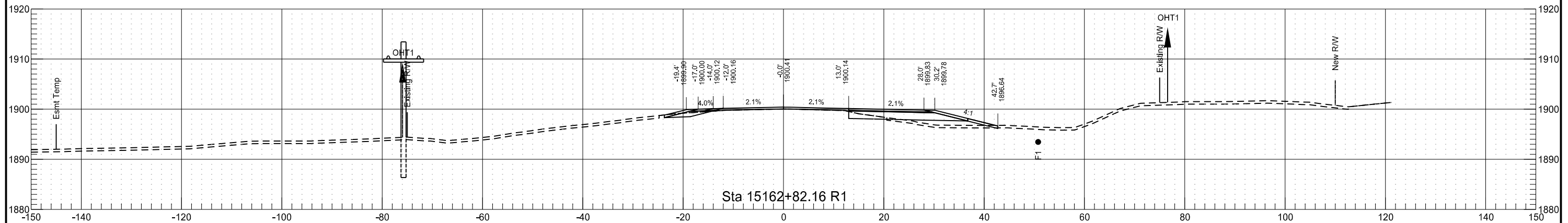

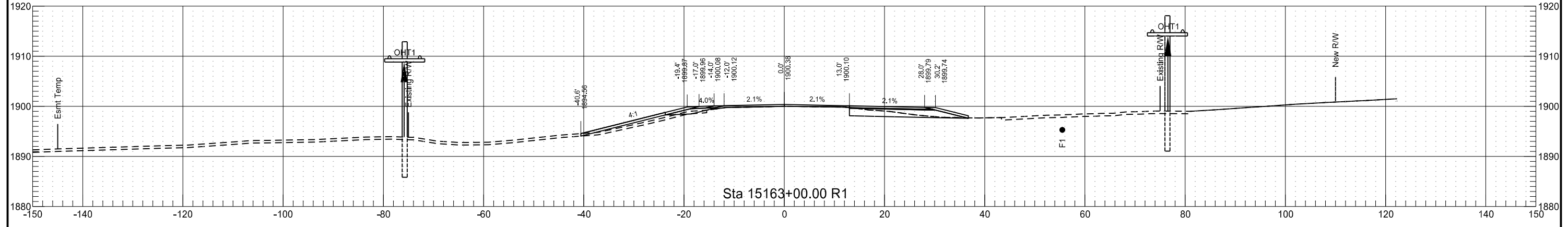
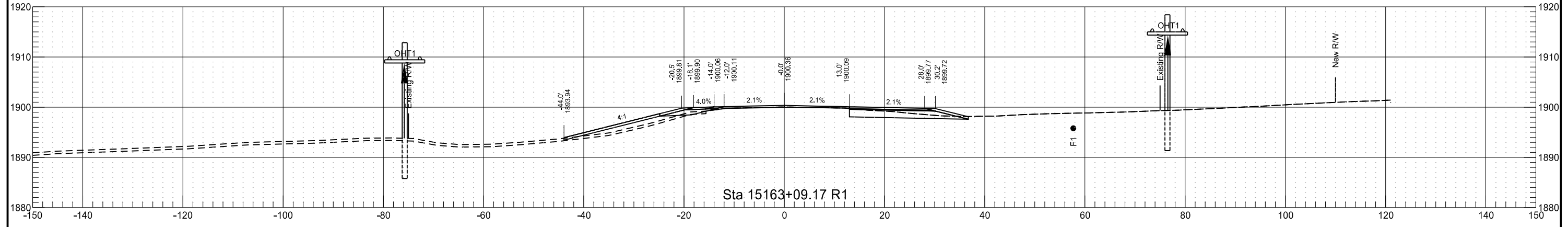
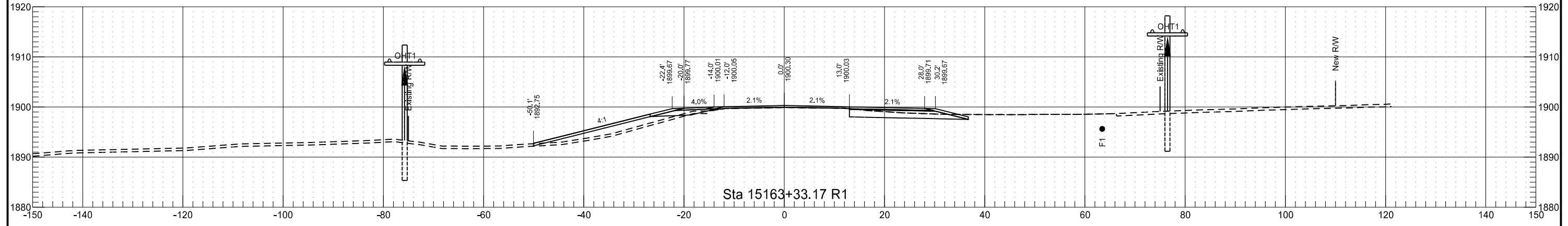
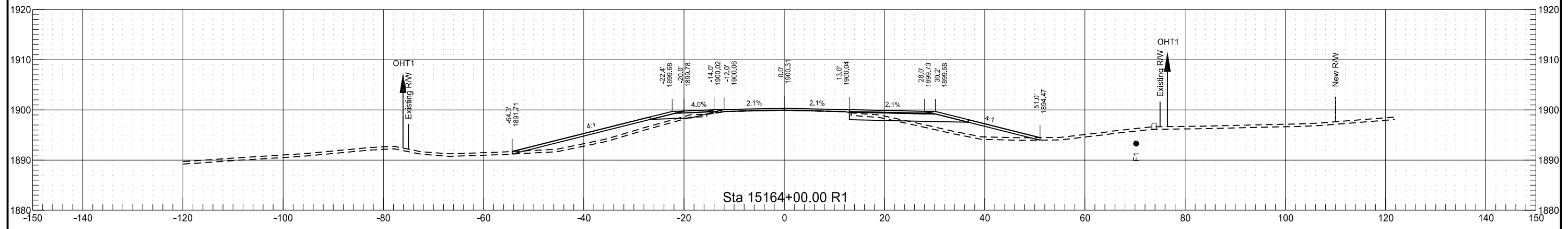

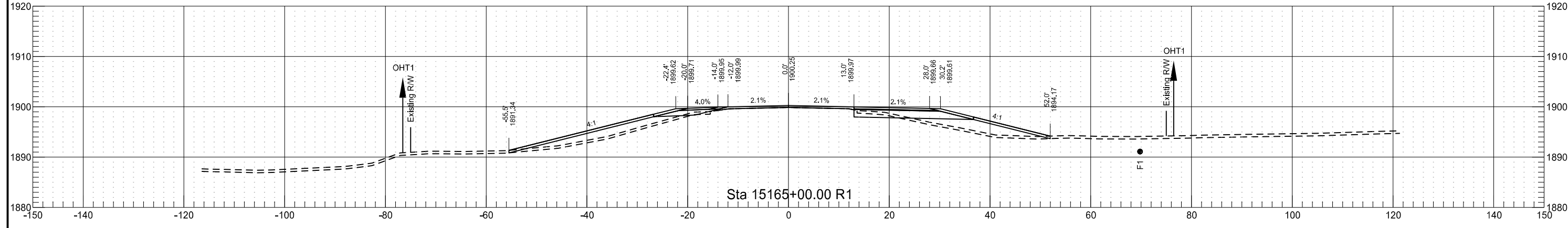
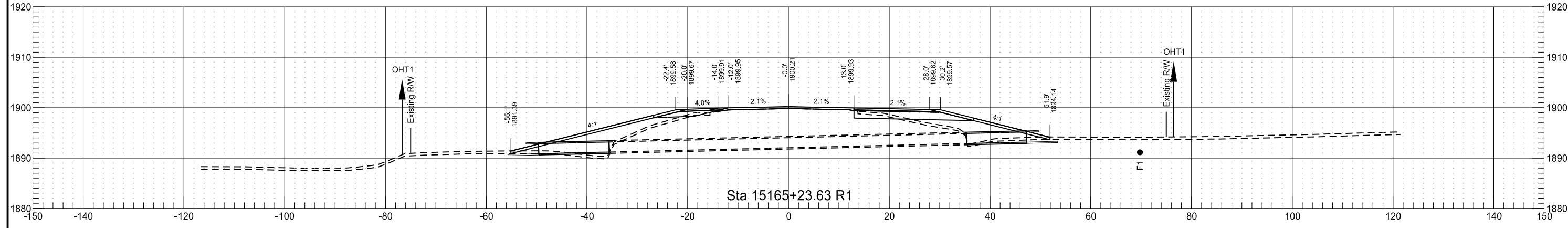
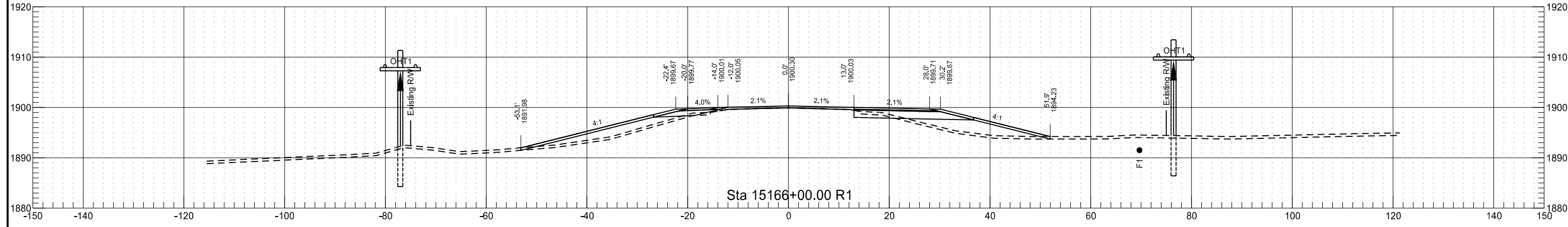
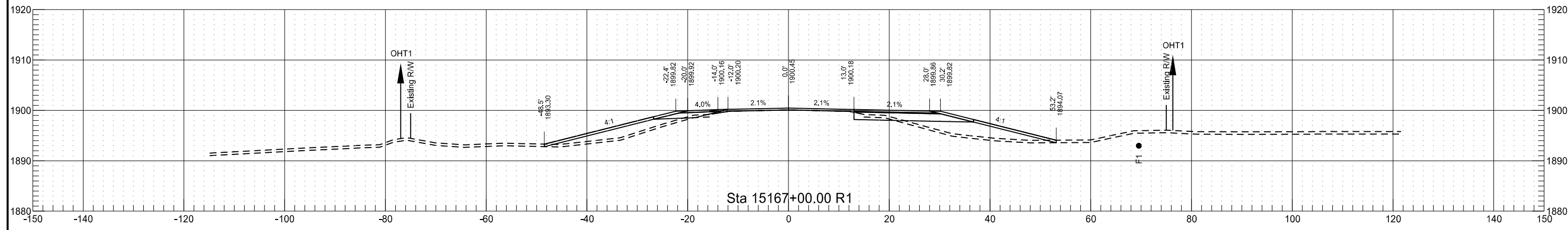

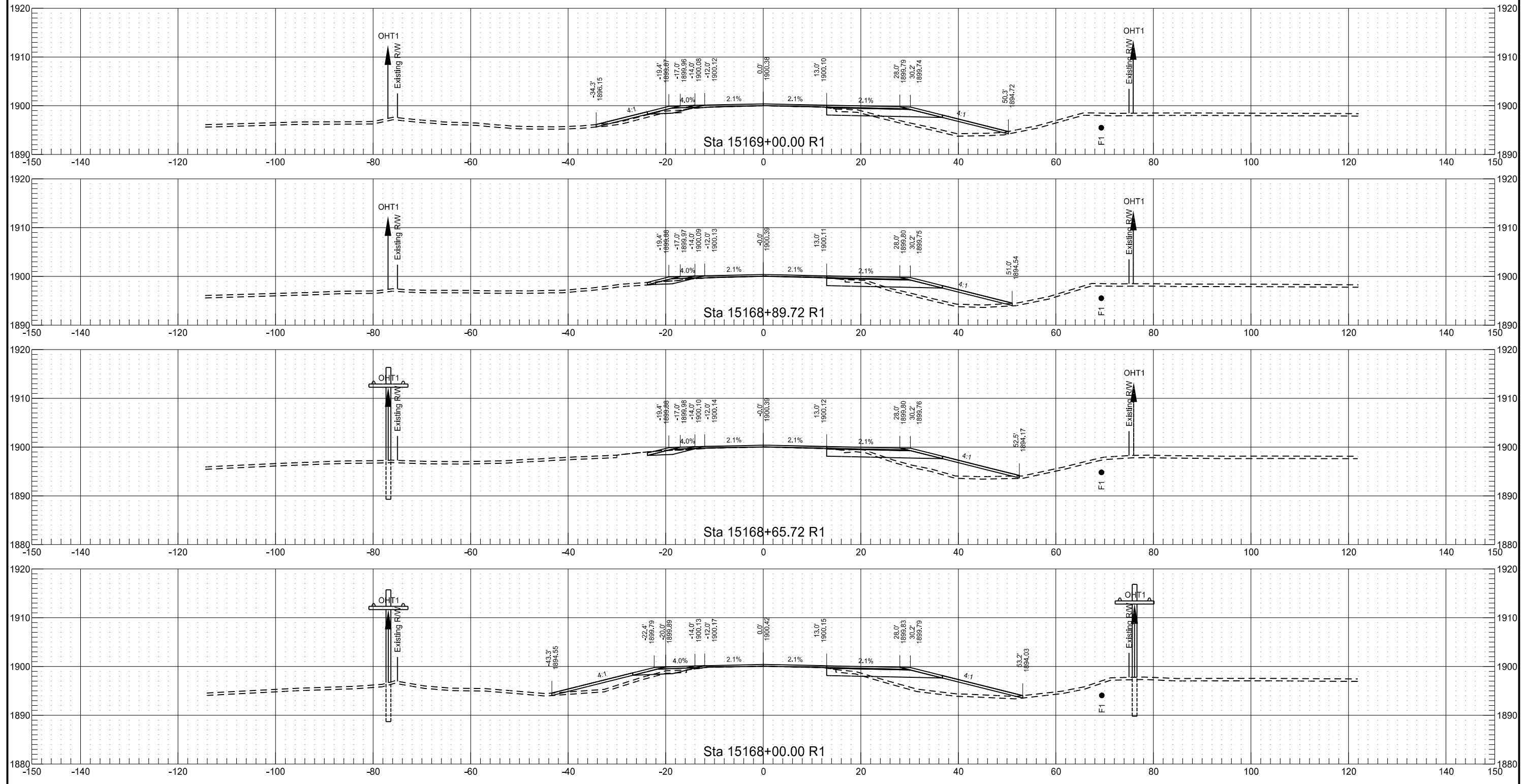

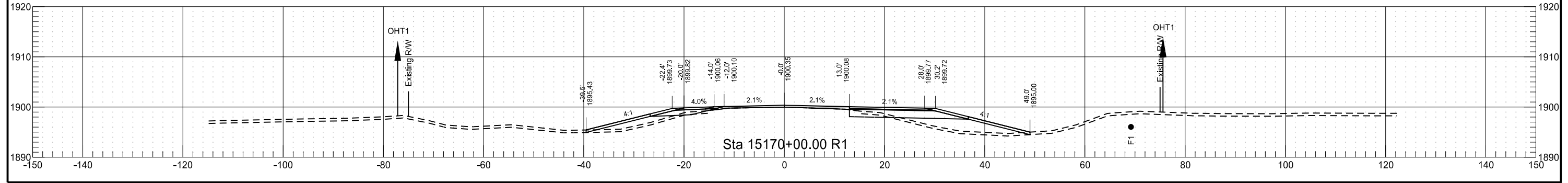
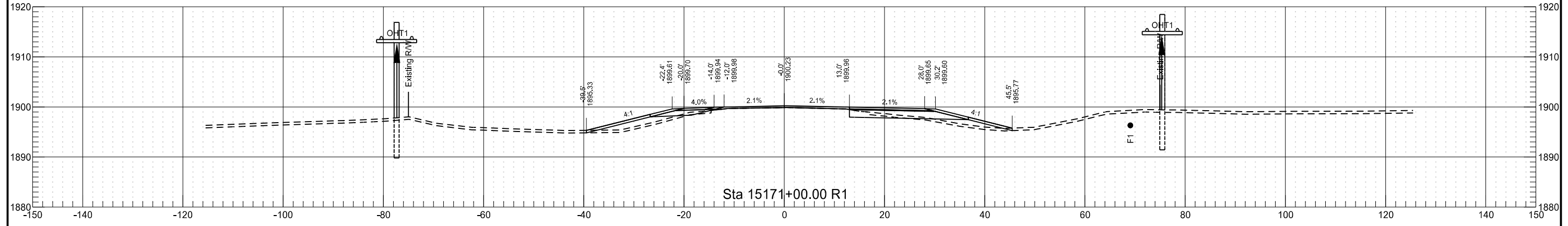
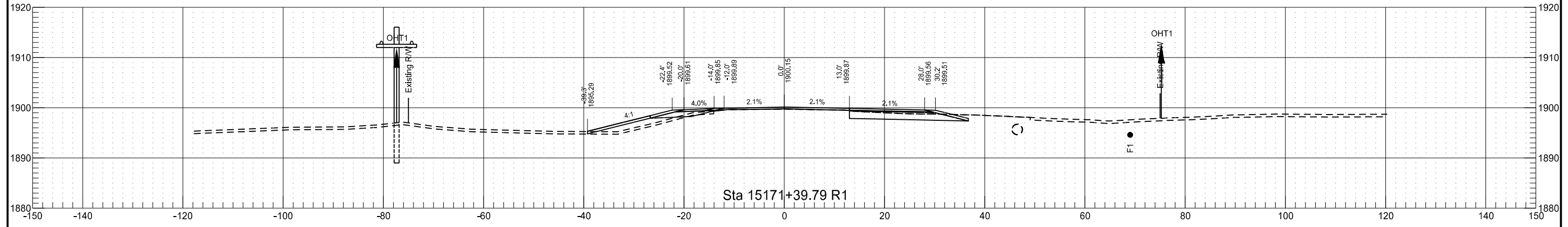
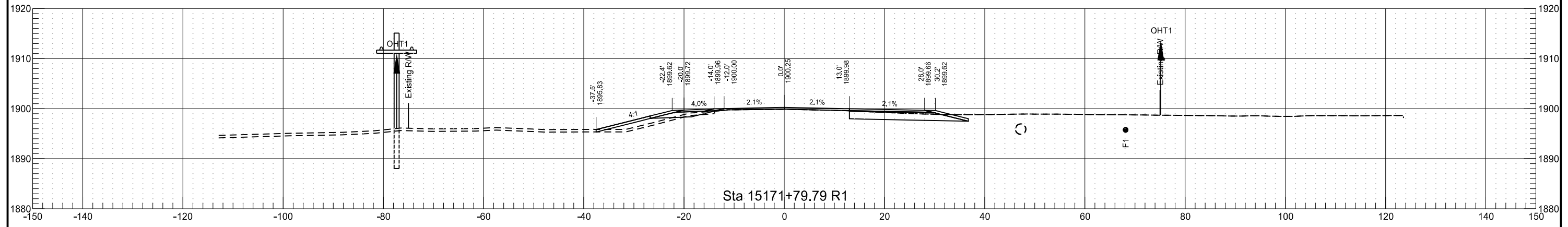

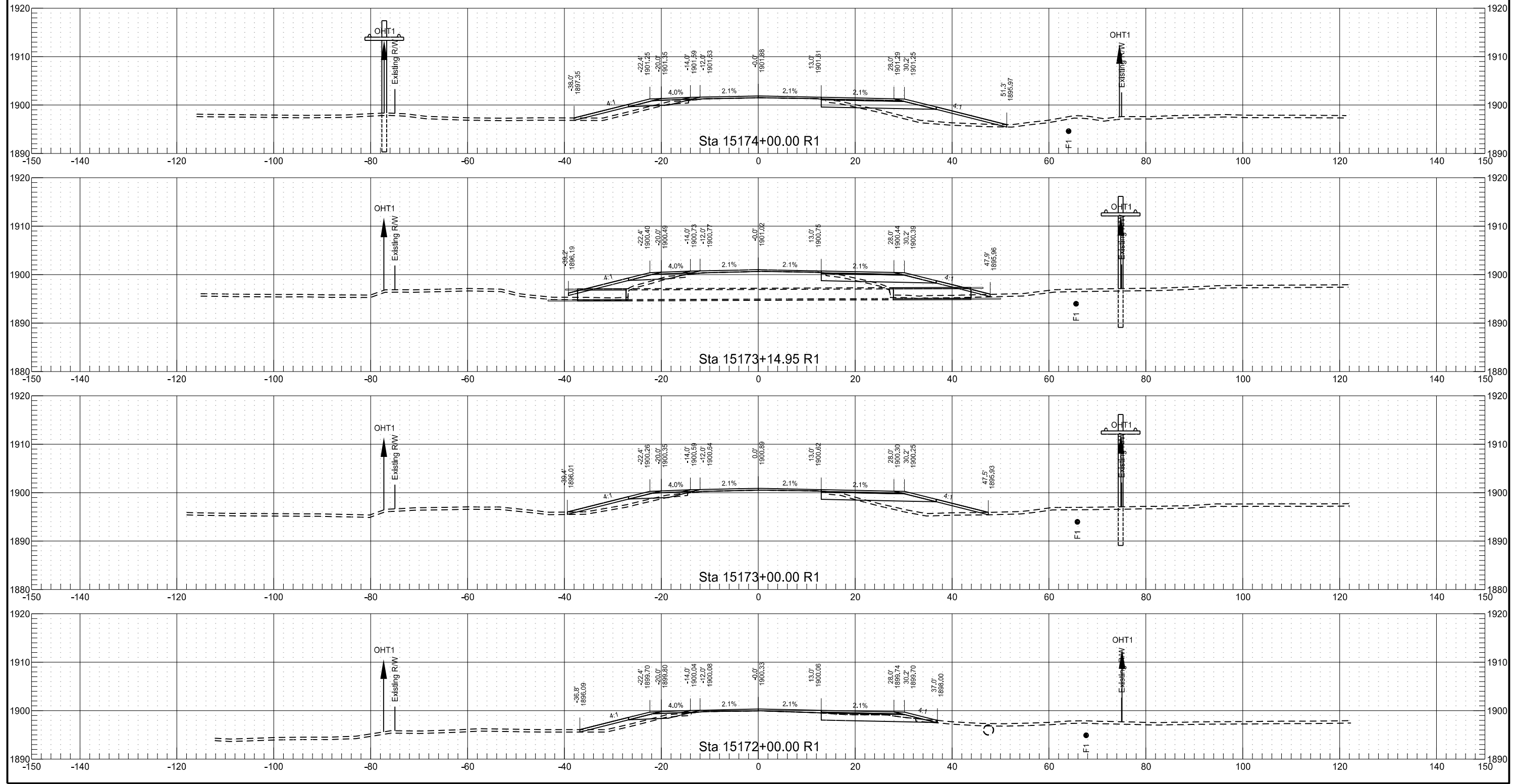

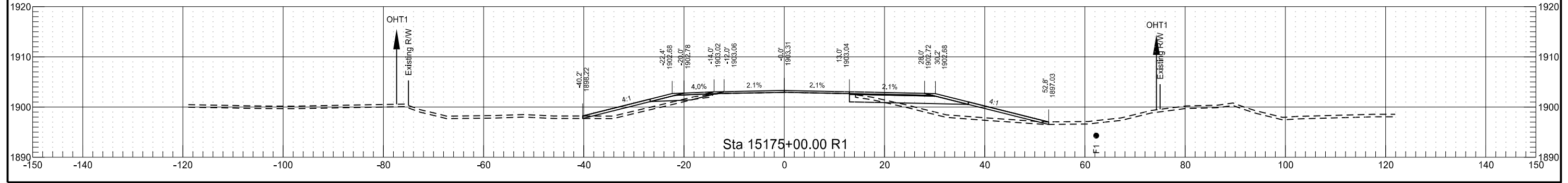
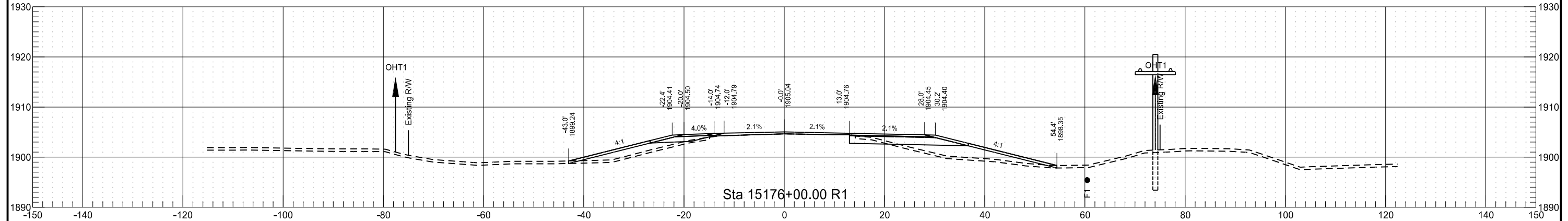
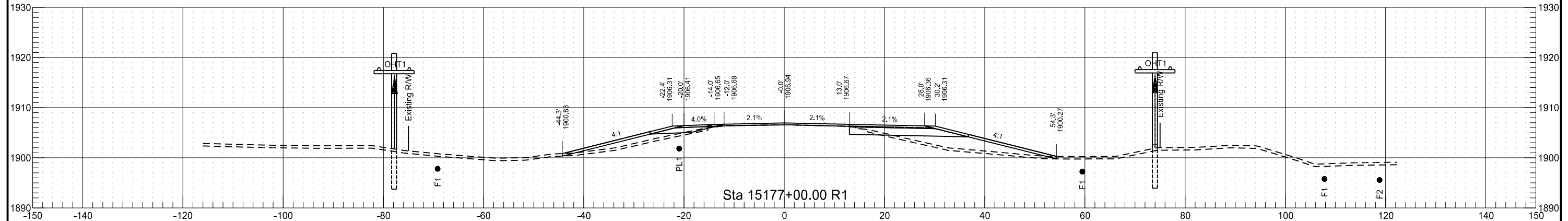
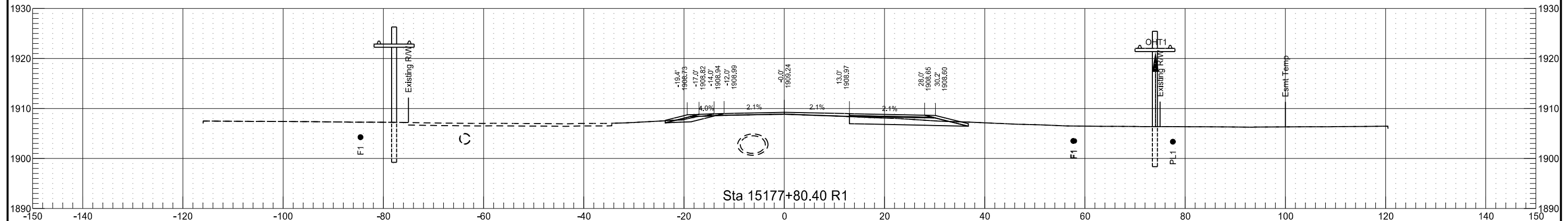

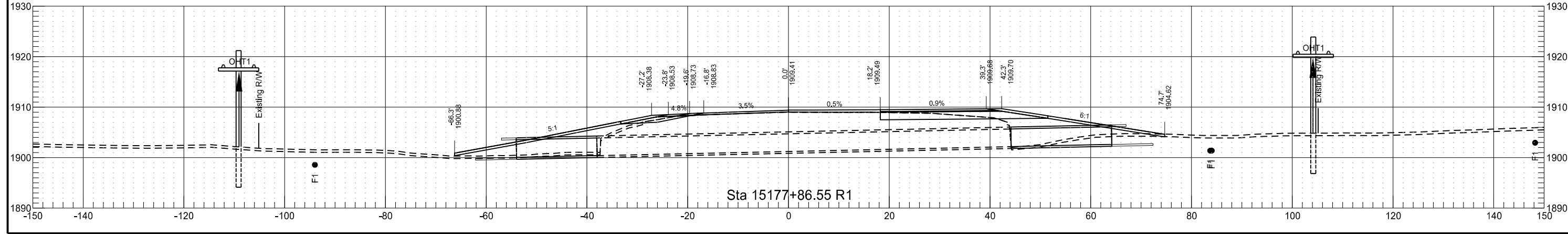
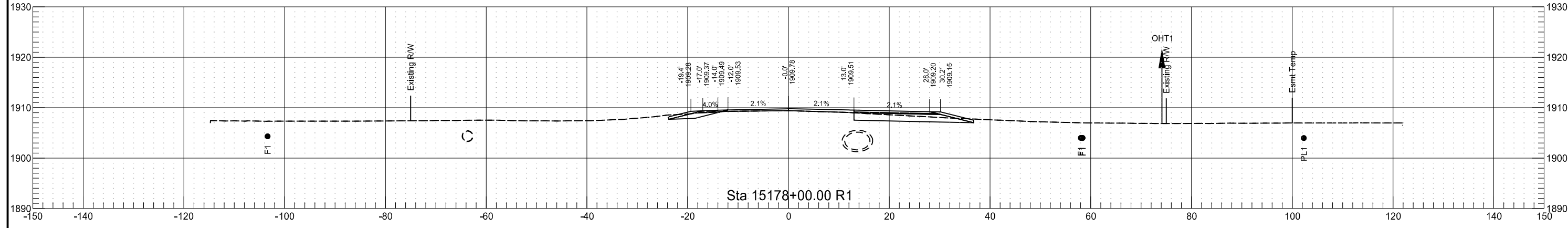
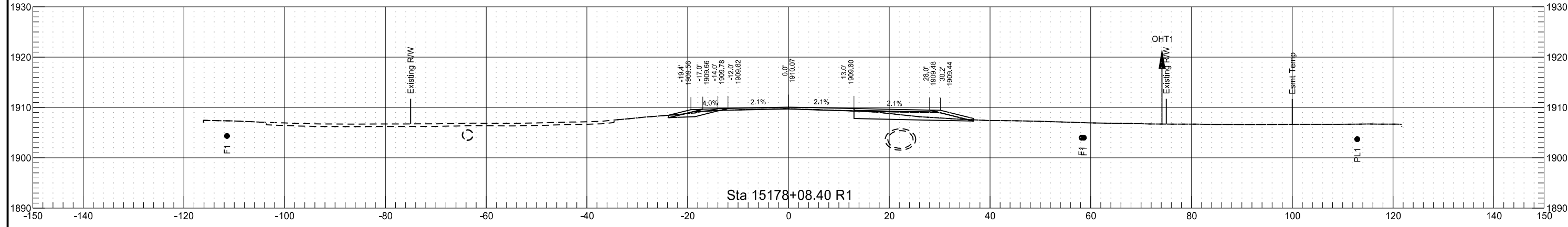
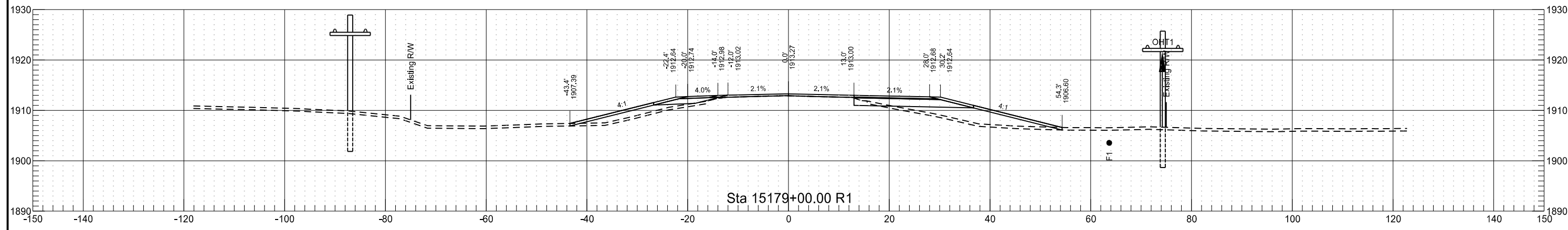

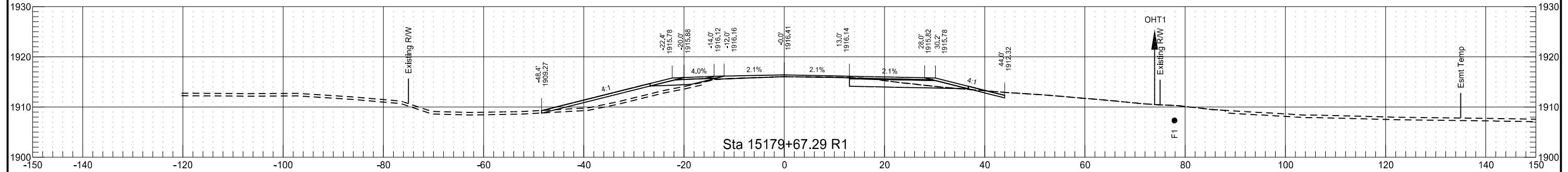
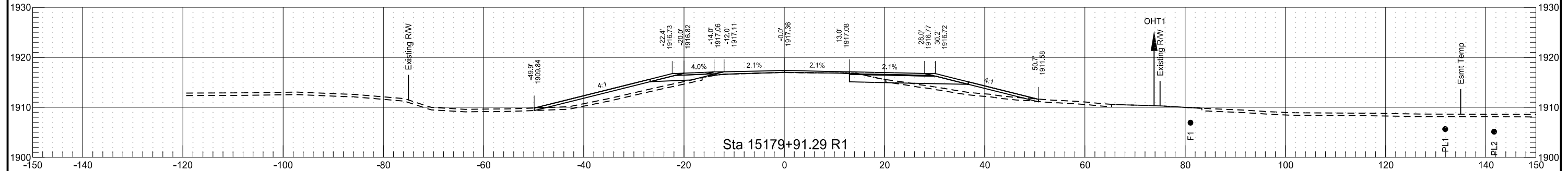
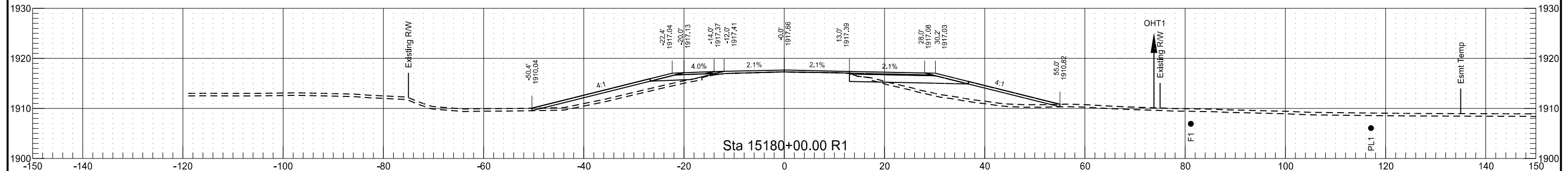
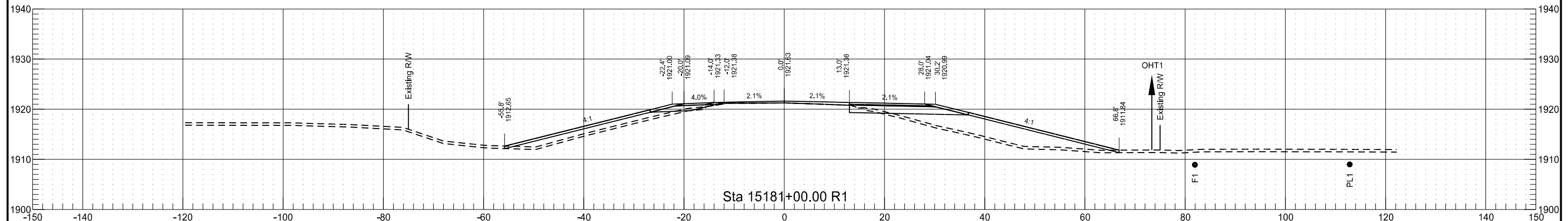

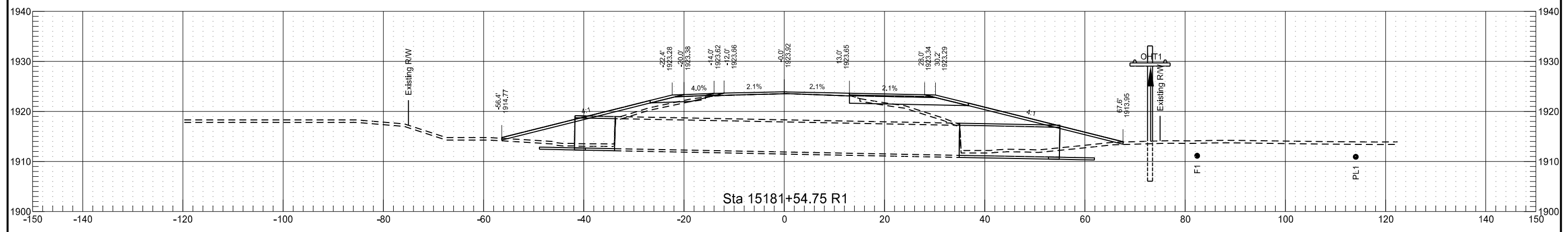
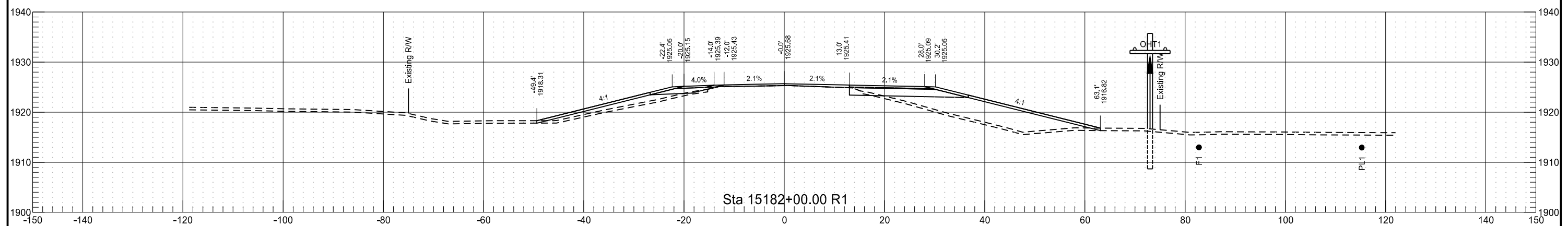
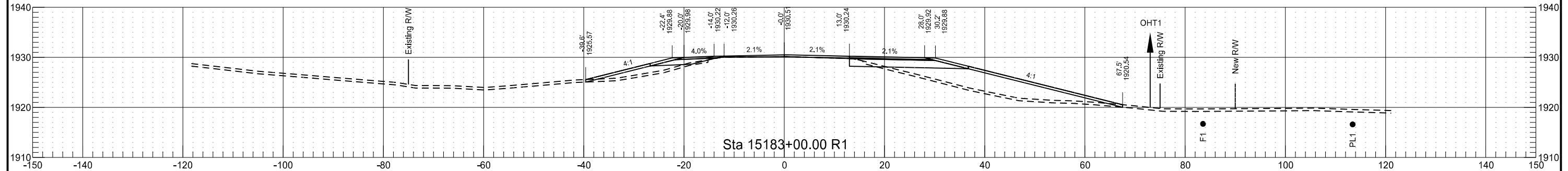
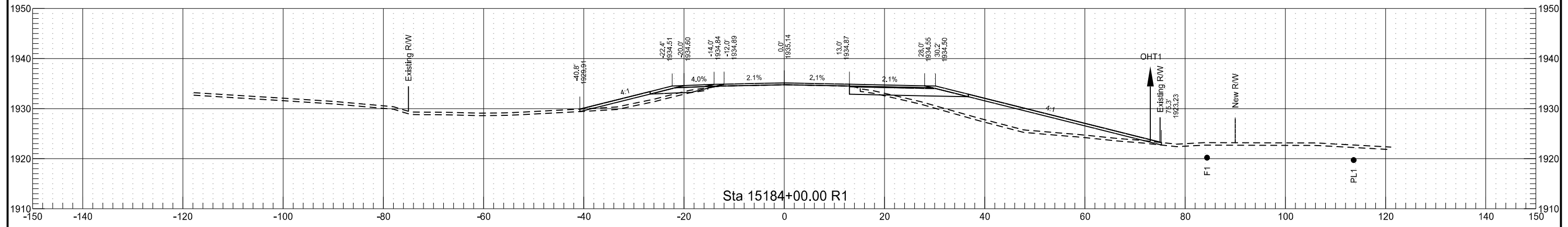

	STATE	PROJECT NO.	SECTION NO.	SHEET NO.
	ND	SOIB-7-804(061)283	200	86

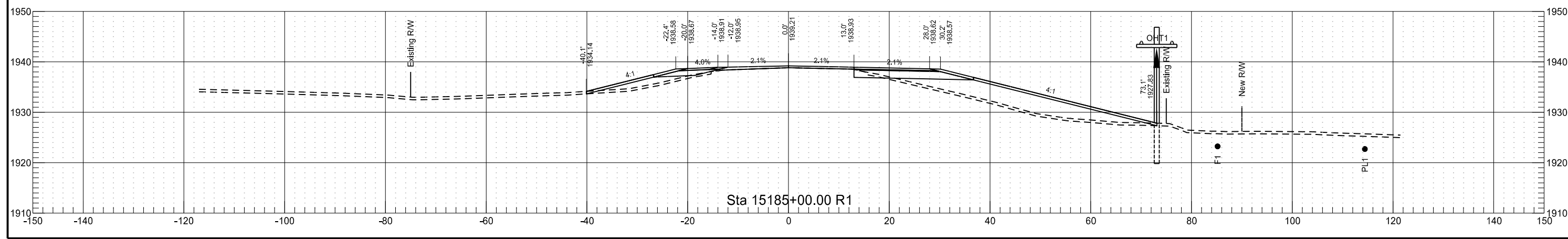
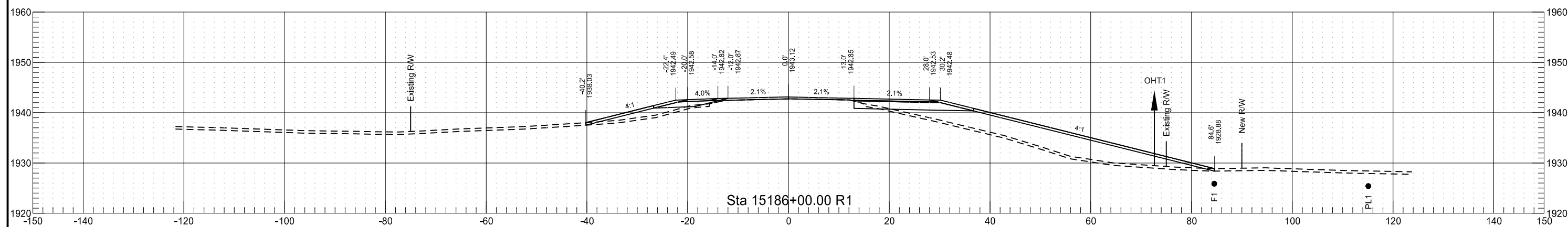
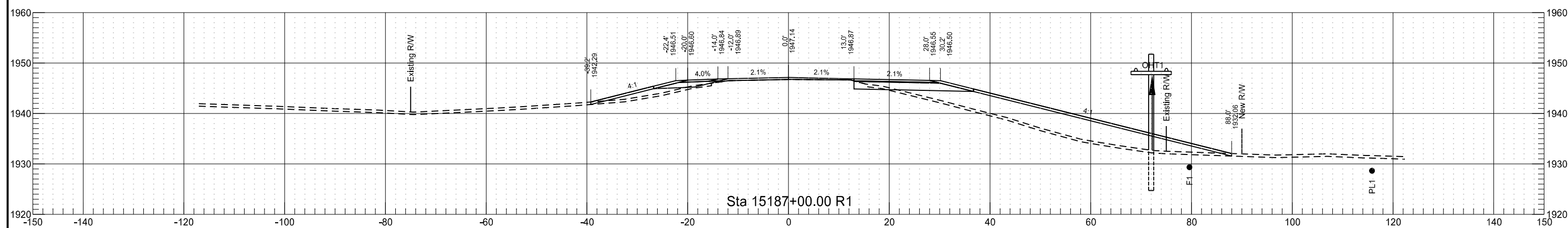
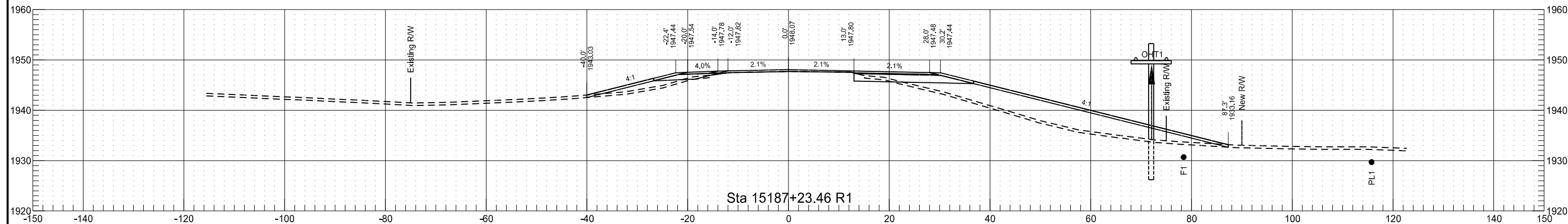

	STATE	PROJECT NO.	SECTION NO.	SHEET NO.
	ND	SOIB-7-804(061)283	200	87

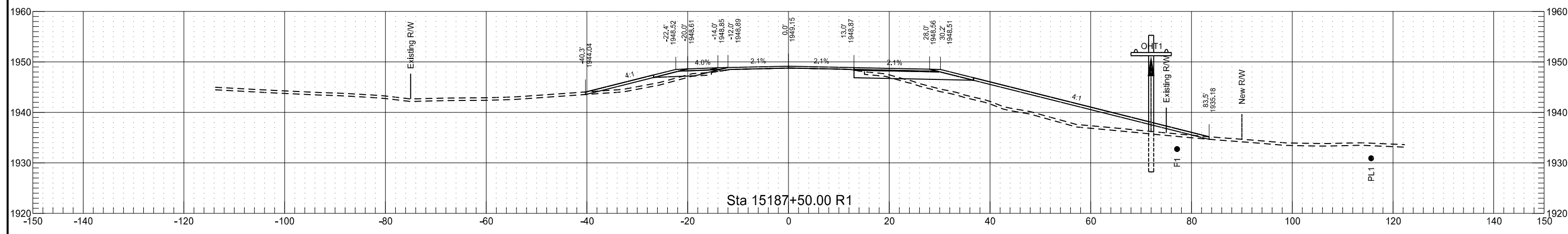
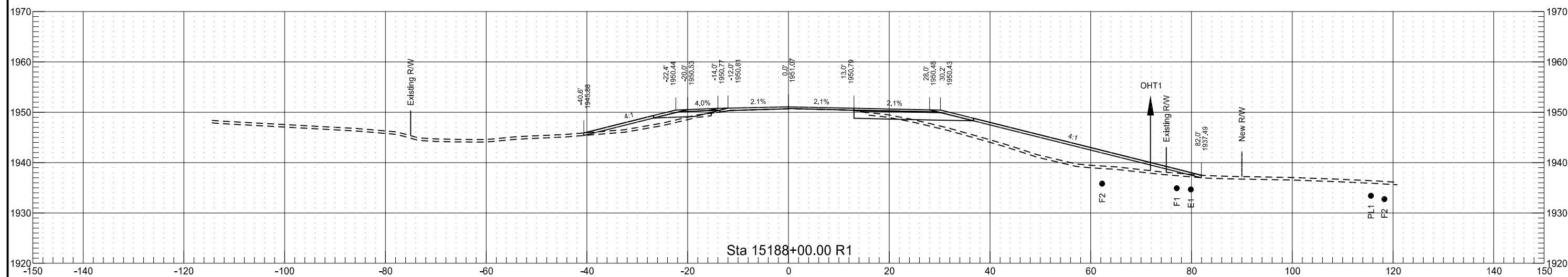
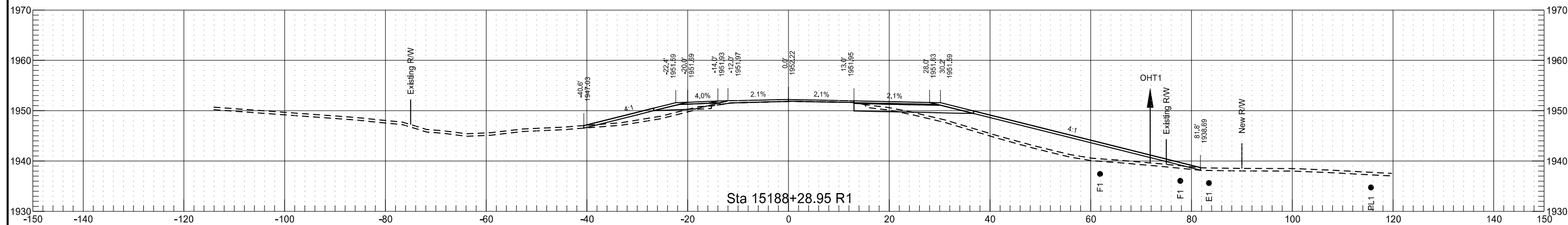

STATE	PROJECT NO.	SECTION NO.	SHEET NO.
ND	SOIB-7-804(061)283	200	88

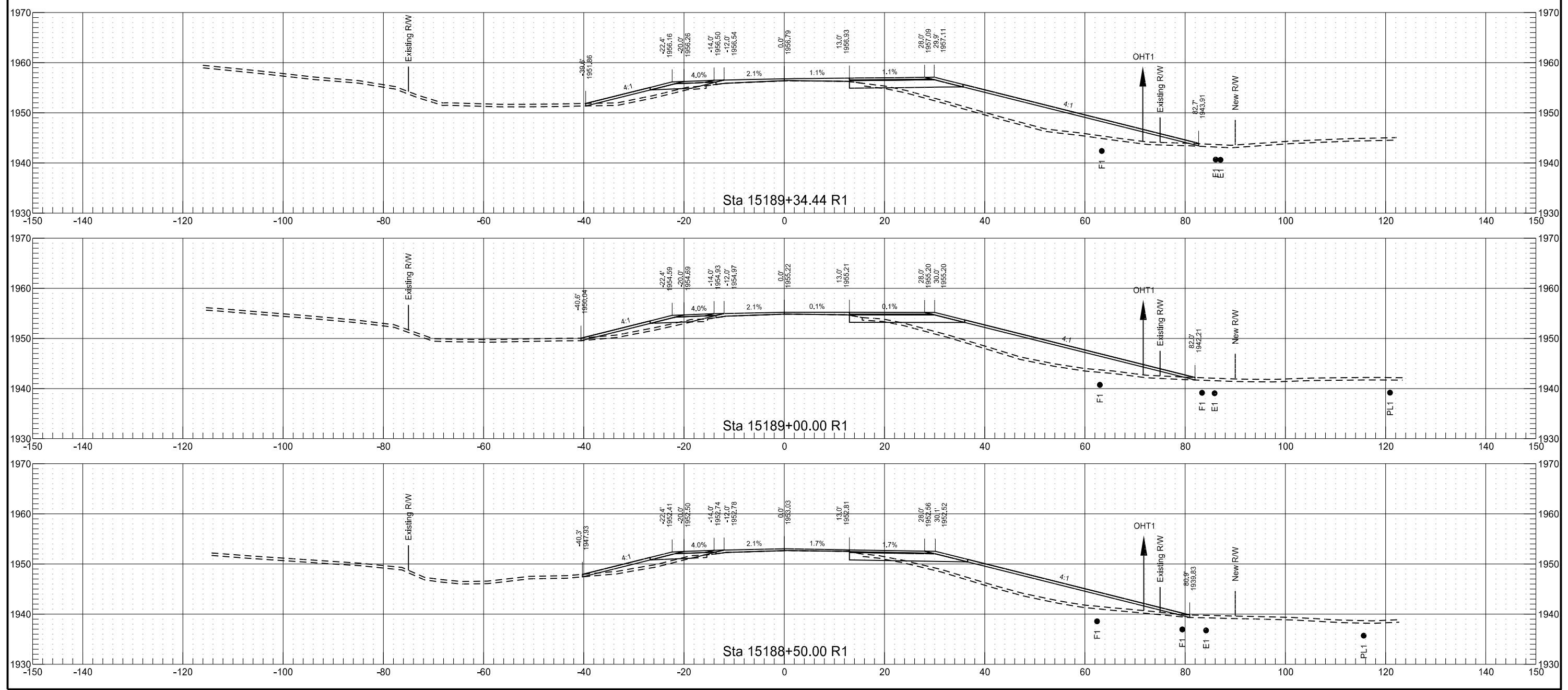

	STATE	PROJECT NO.	SECTION NO.	SHEET NO.
	ND	SOIB-7-804(061)283	200	89

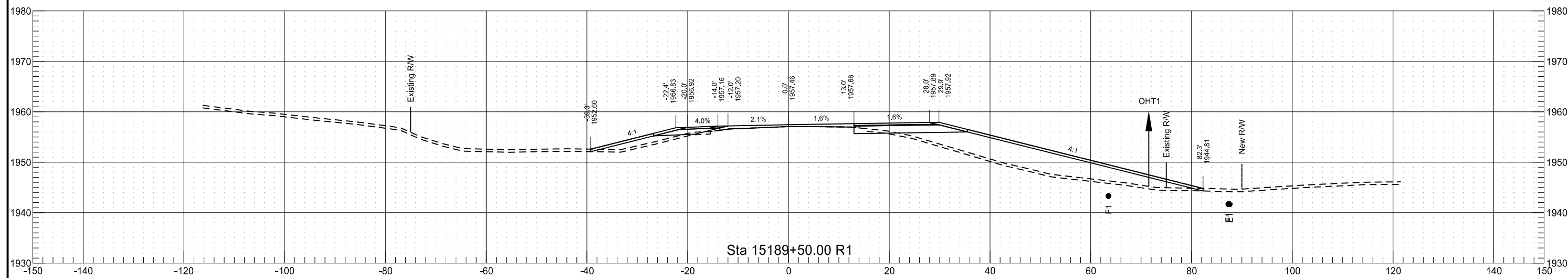
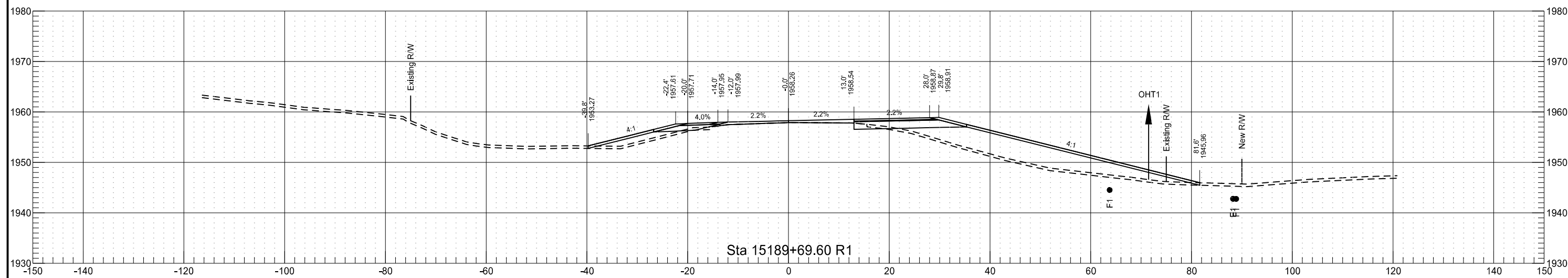
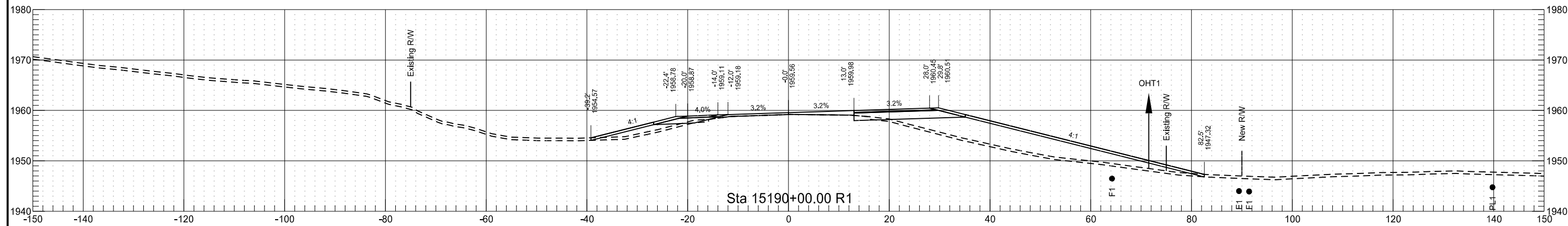

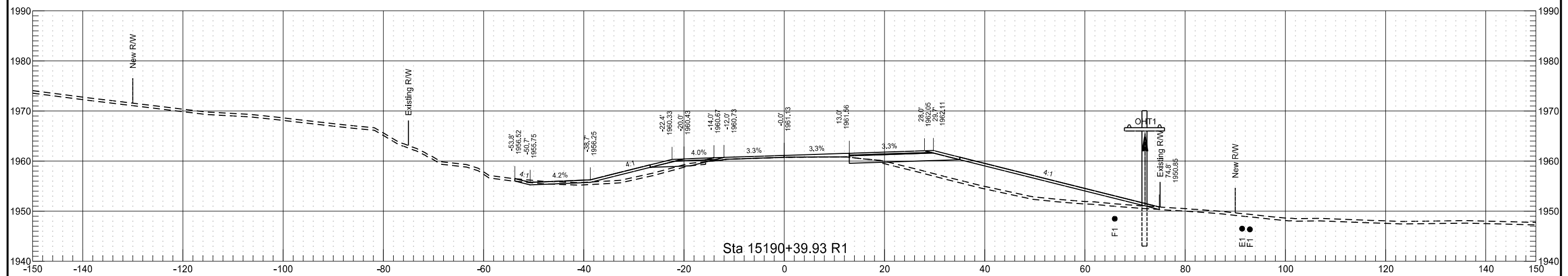
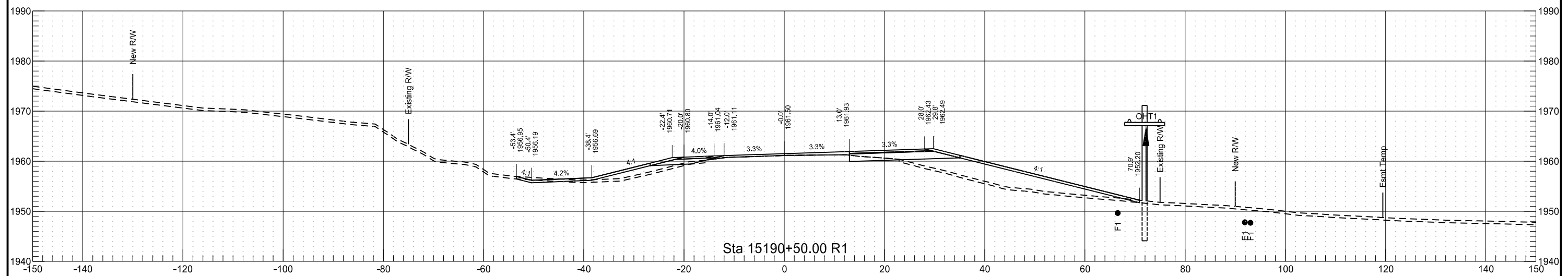
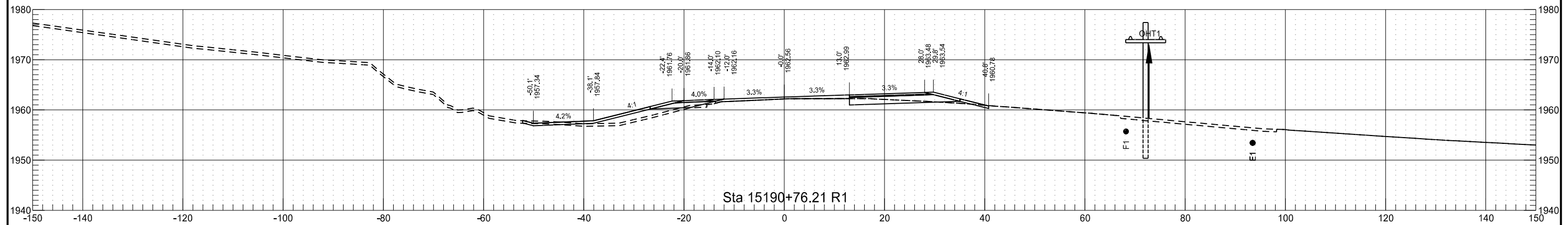

STATE	PROJECT NO.	SECTION NO.	SHEET NO.
ND	SOIB-7-804(061)283	200	91

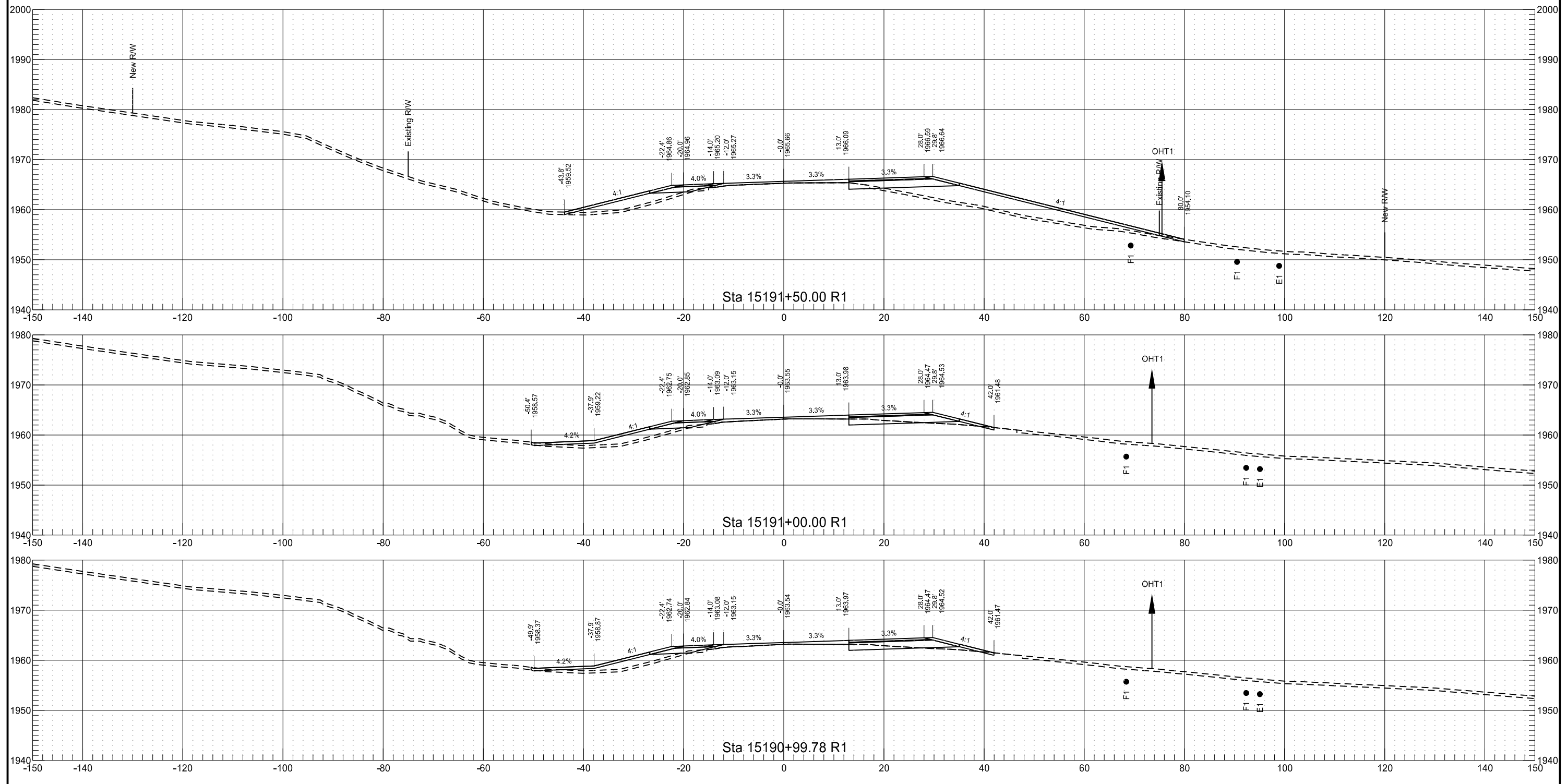

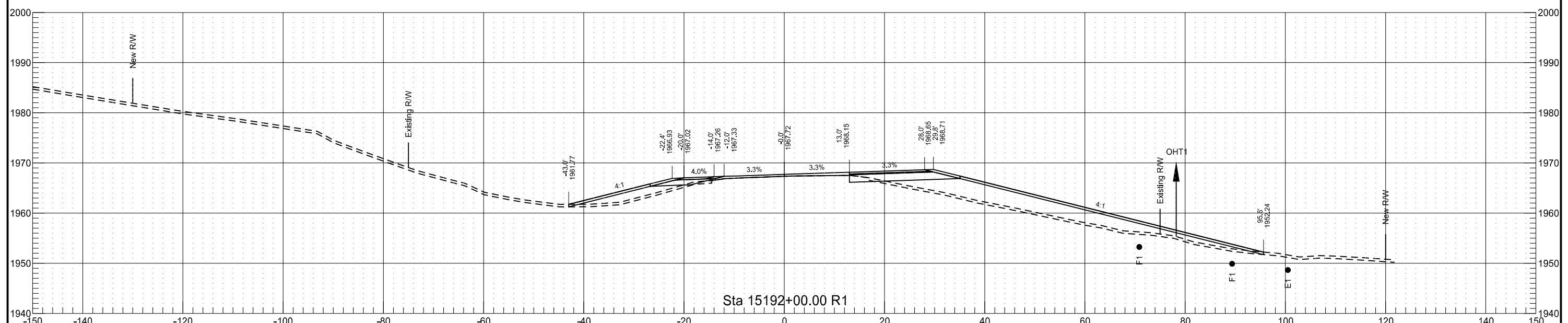
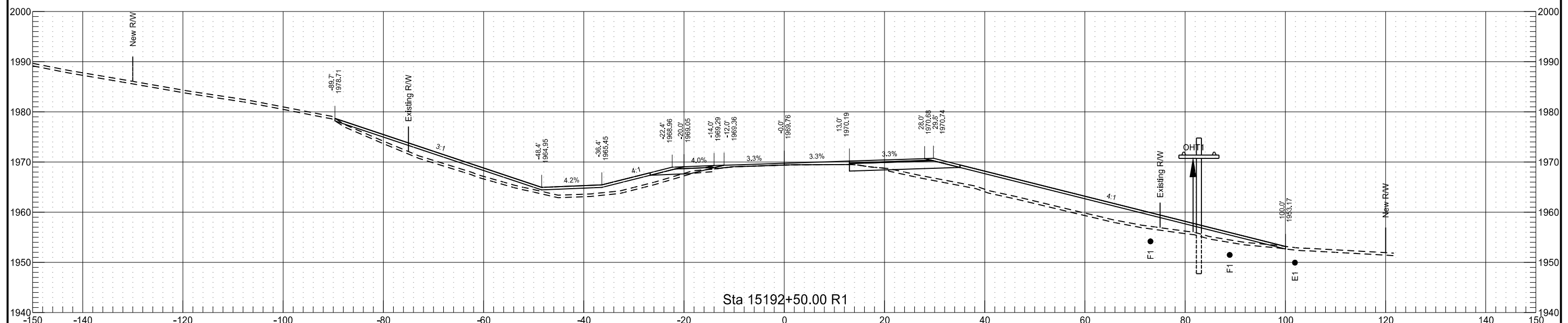

	STATE	PROJECT NO.	SECTION NO.	SHEET NO.
	ND	SOIB-7-804(061)283	200	93

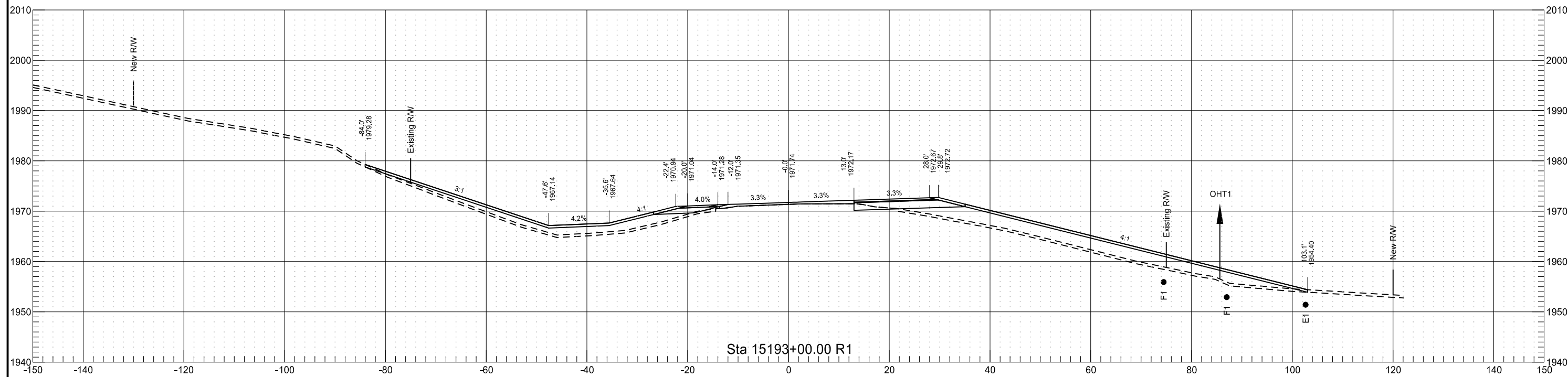
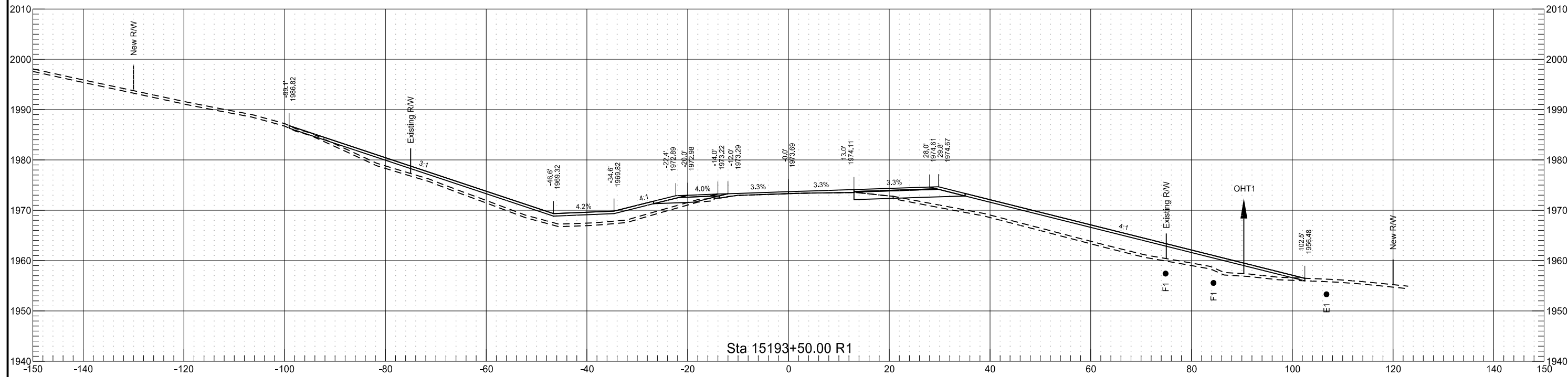

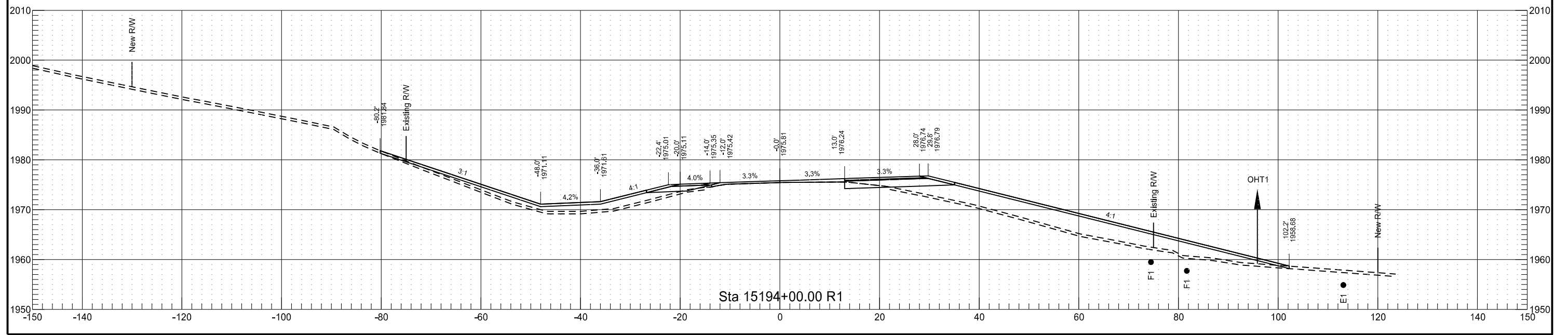
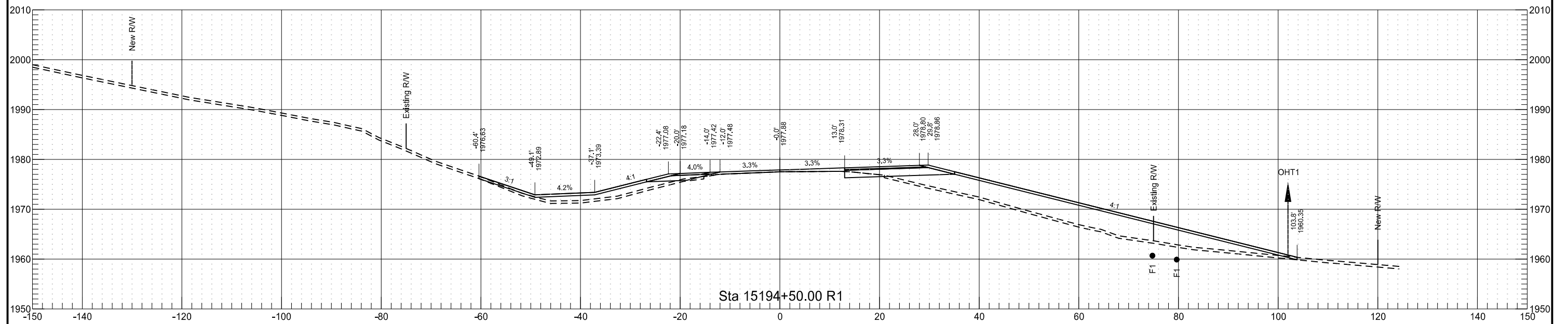

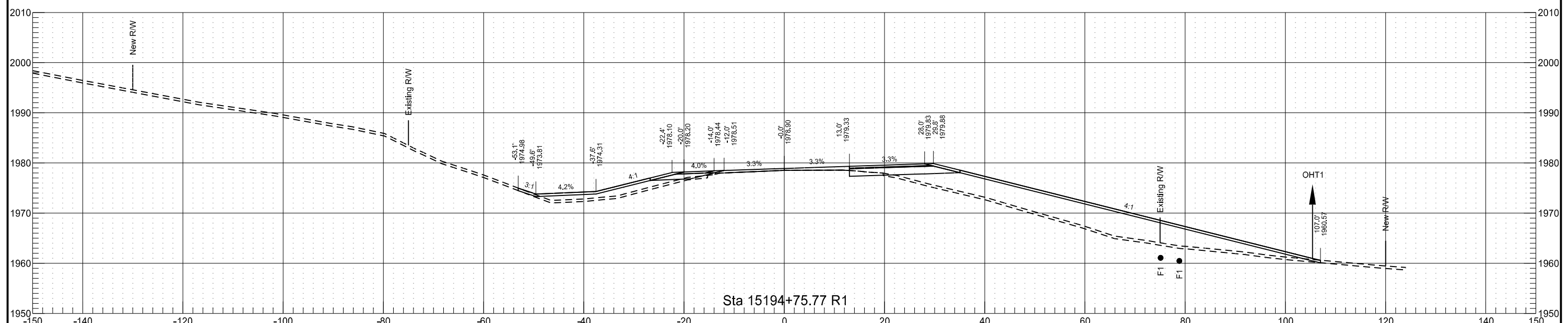
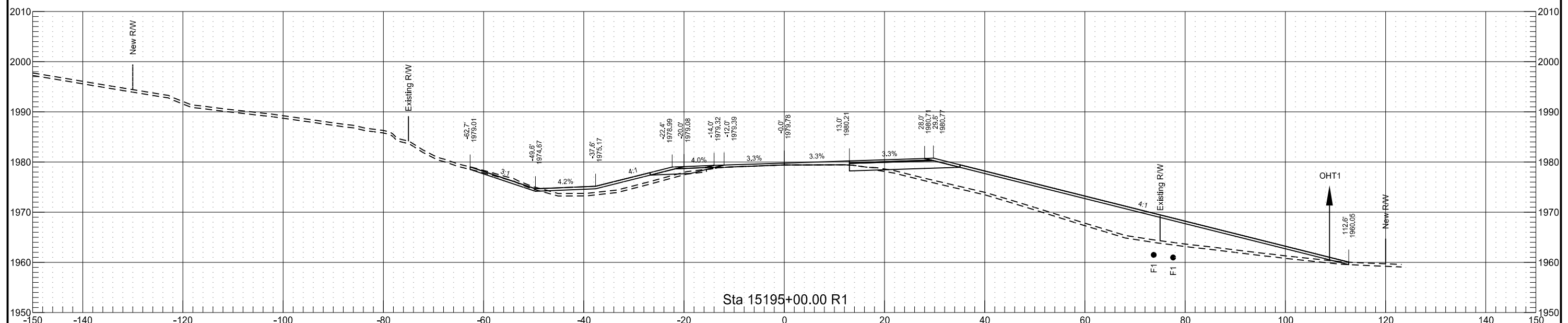

STATE	PROJECT NO.	SECTION NO.	SHEET NO.
ND	SOIB-7-804(061)283	200	96

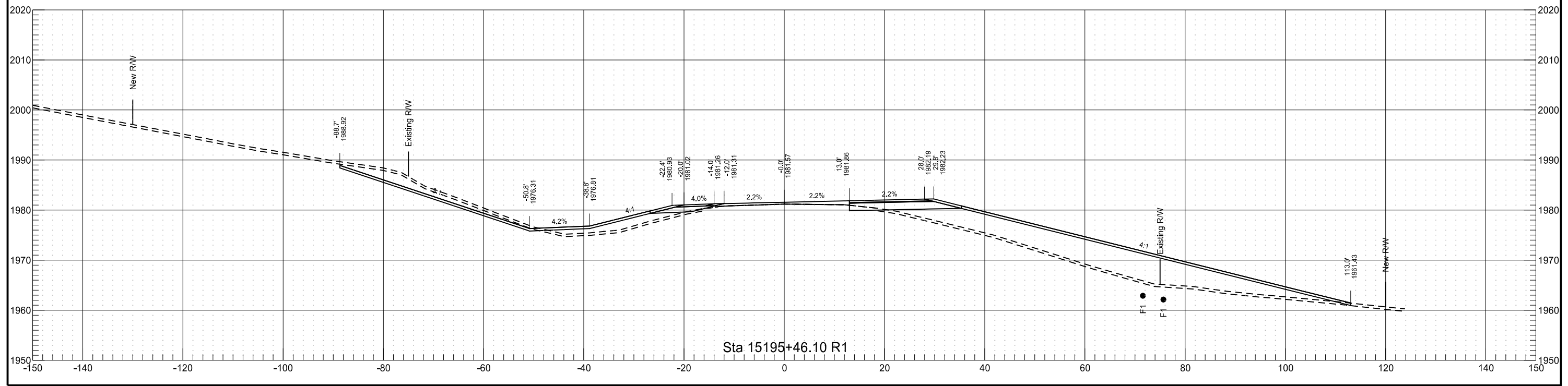
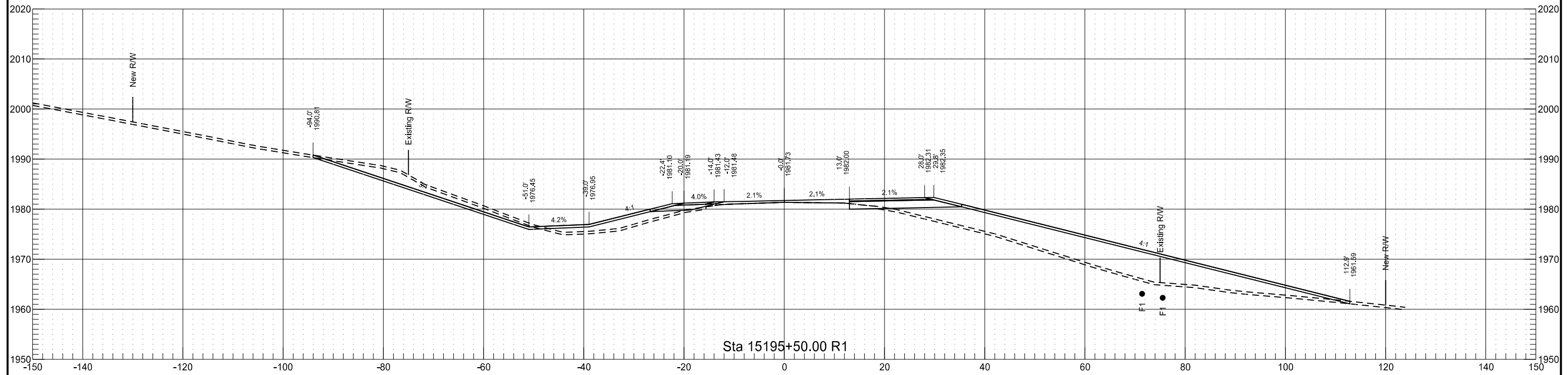

	STATE	PROJECT NO.	SECTION NO.	SHEET NO.
	ND	SOIB-7-804(061)283	200	97

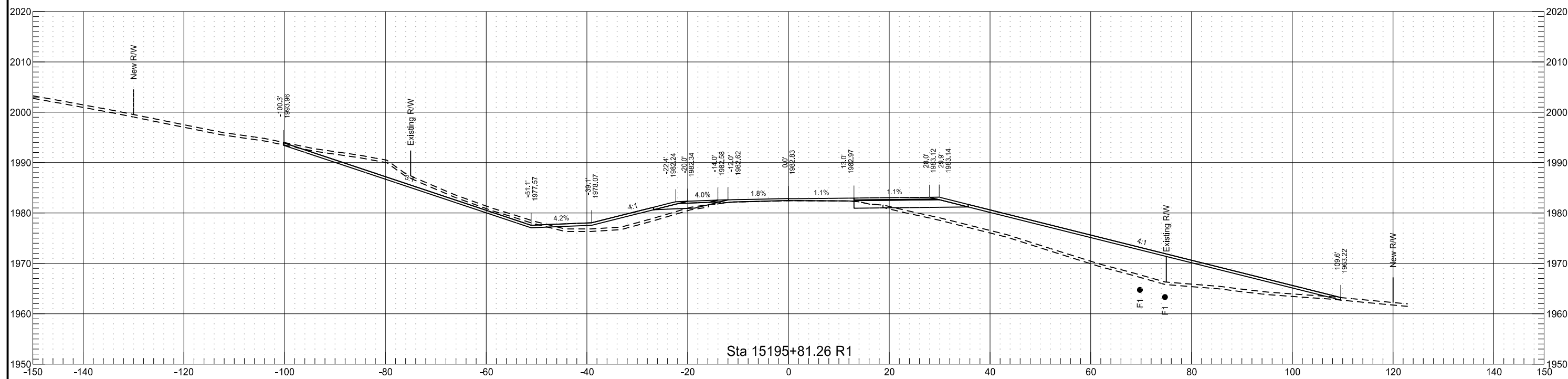
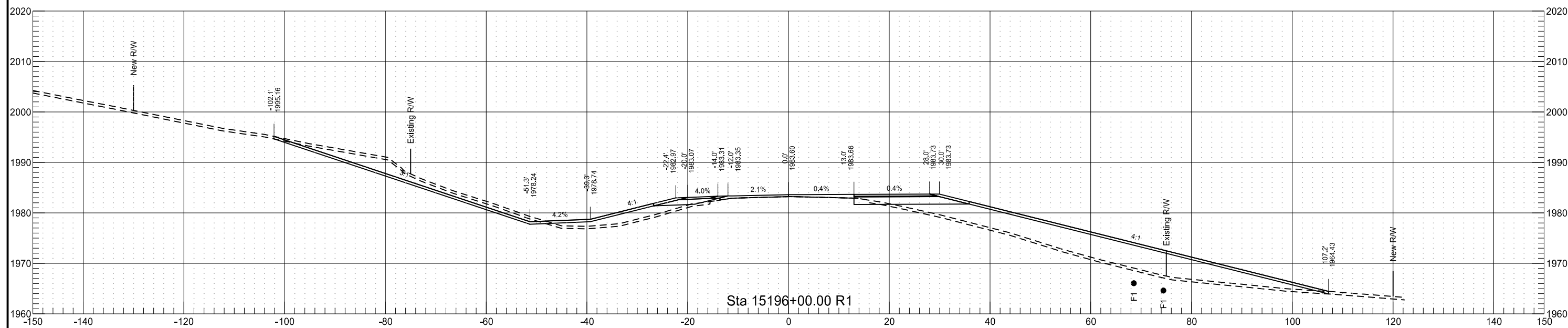

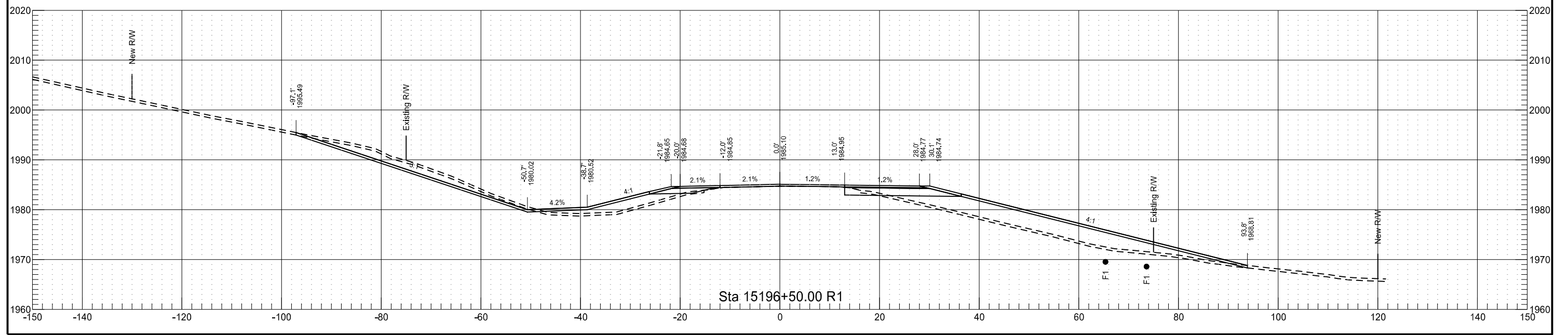
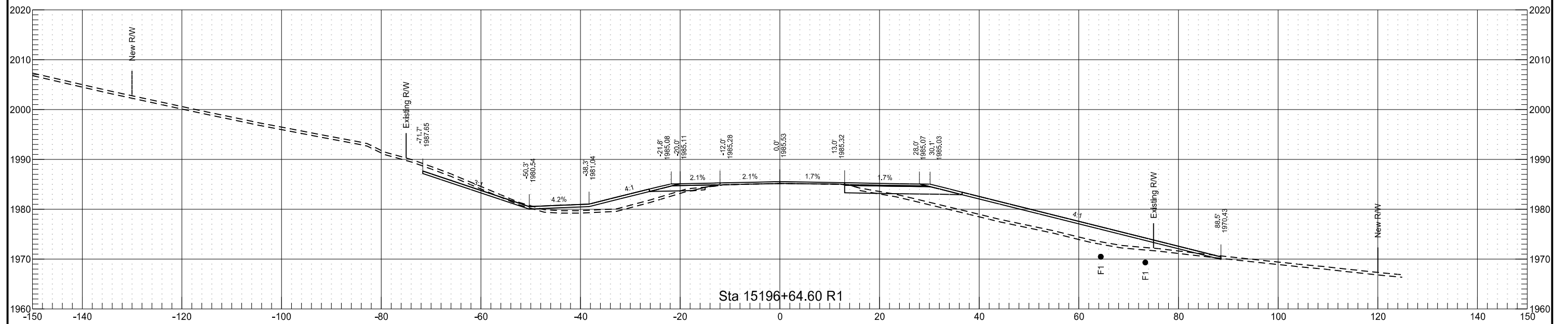

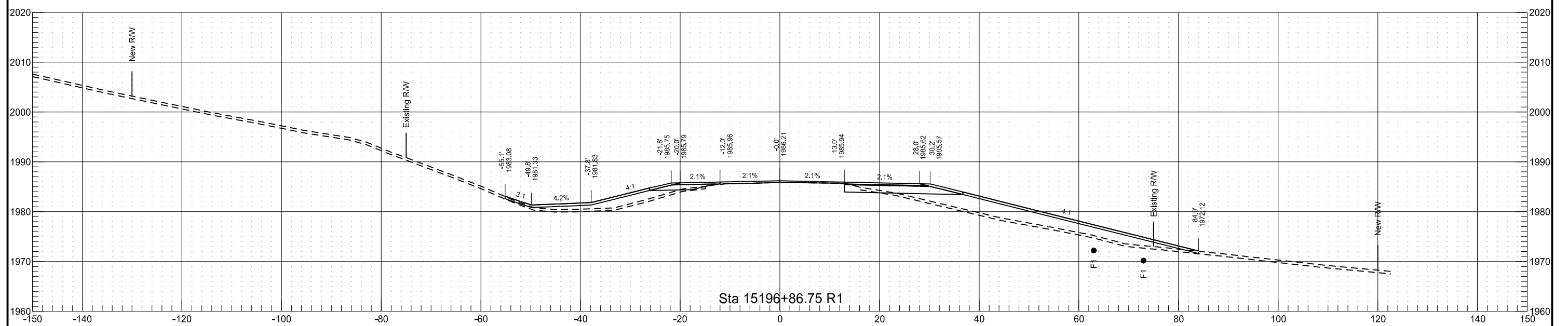
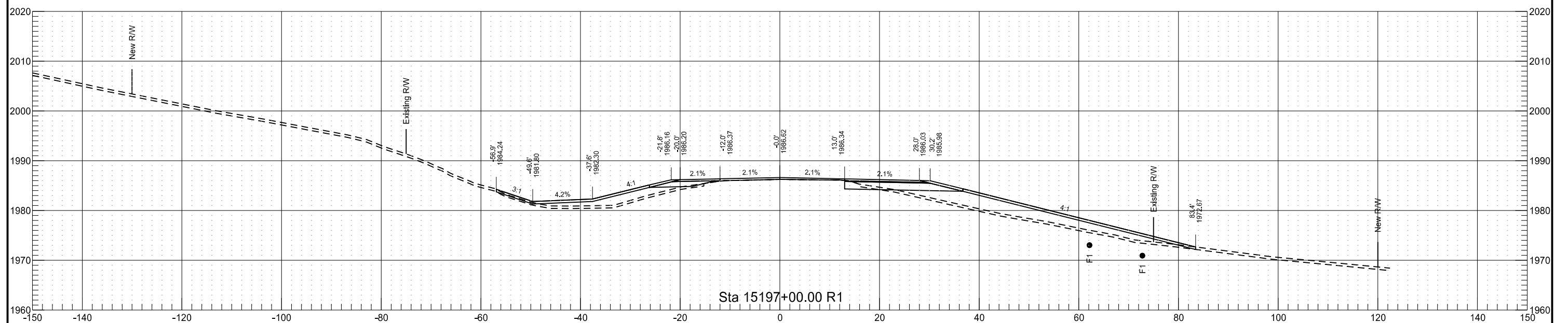

STATE	PROJECT NO.	SECTION NO.	SHEET NO.
ND	SOIB-7-804(061)283	200	100

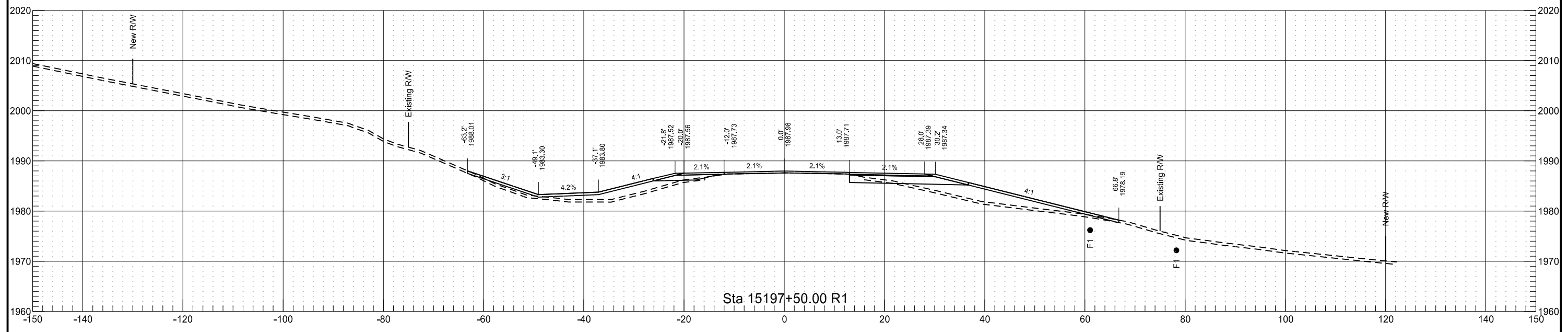
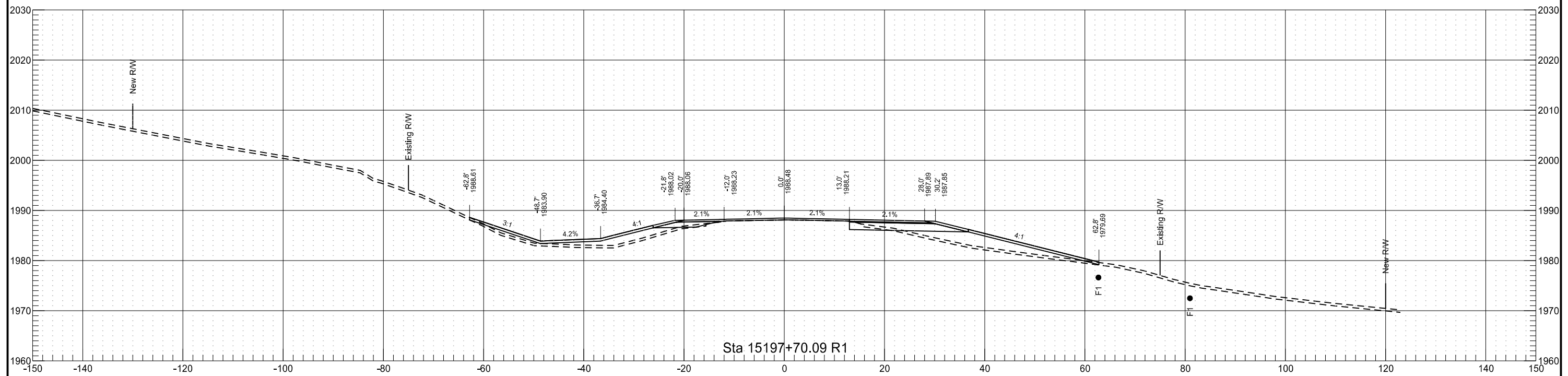

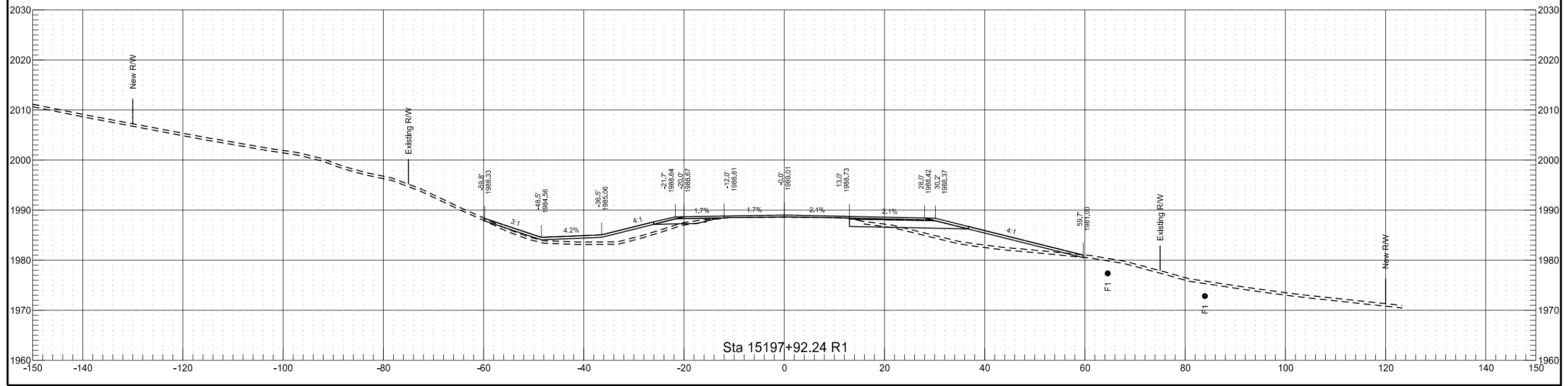
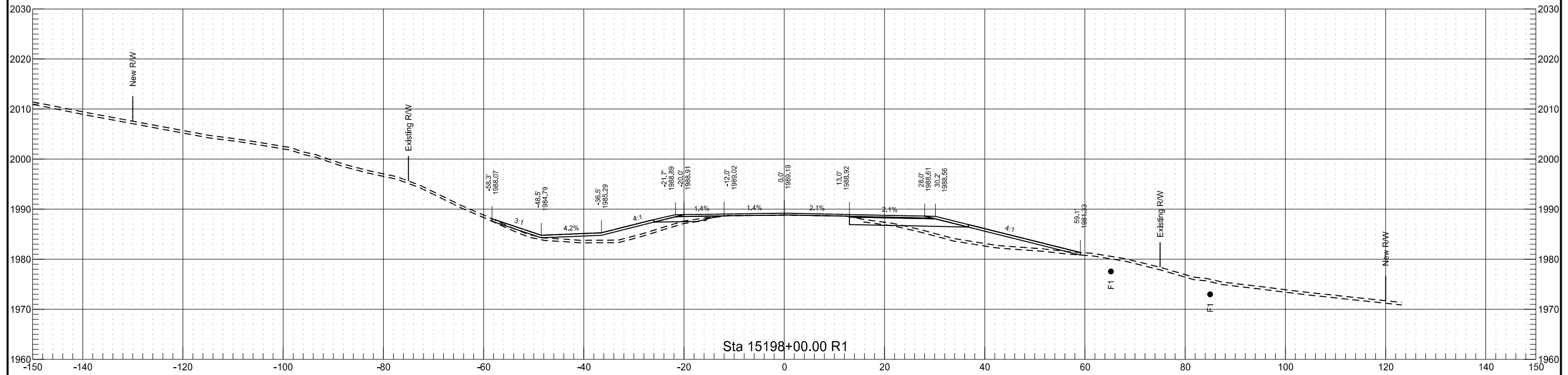

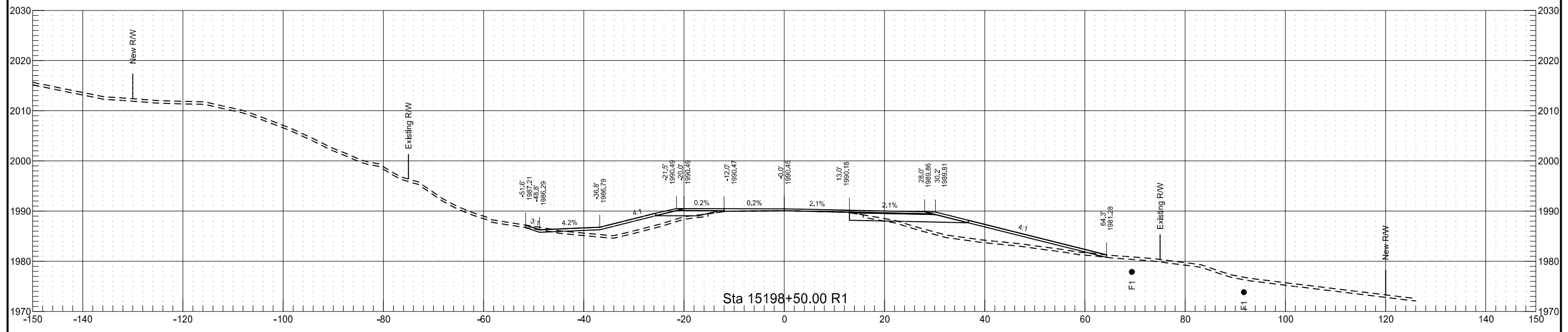
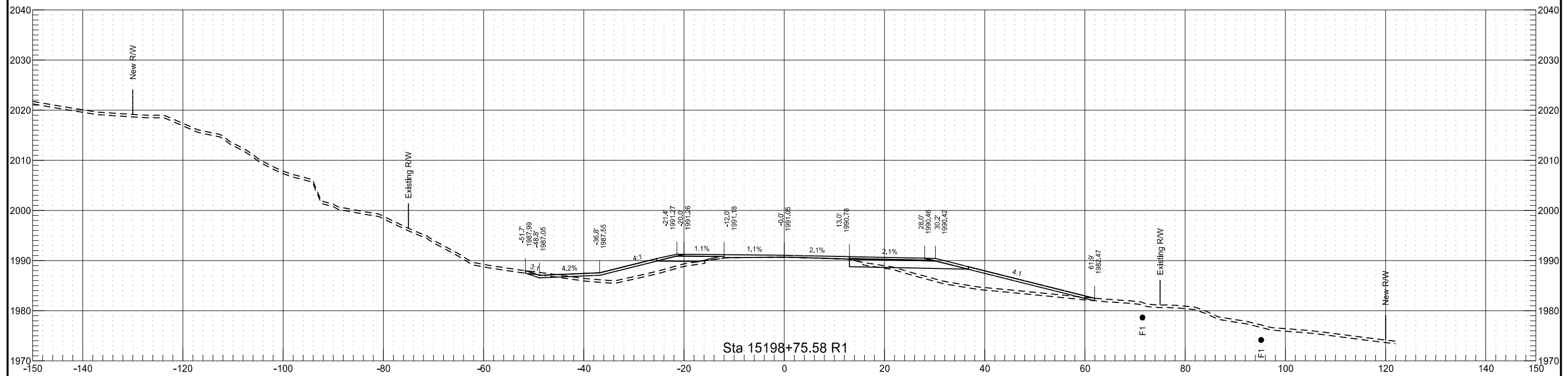

STATE	PROJECT NO.	SECTION NO.	SHEET NO.
ND	SOIB-7-804(061)283	200	103

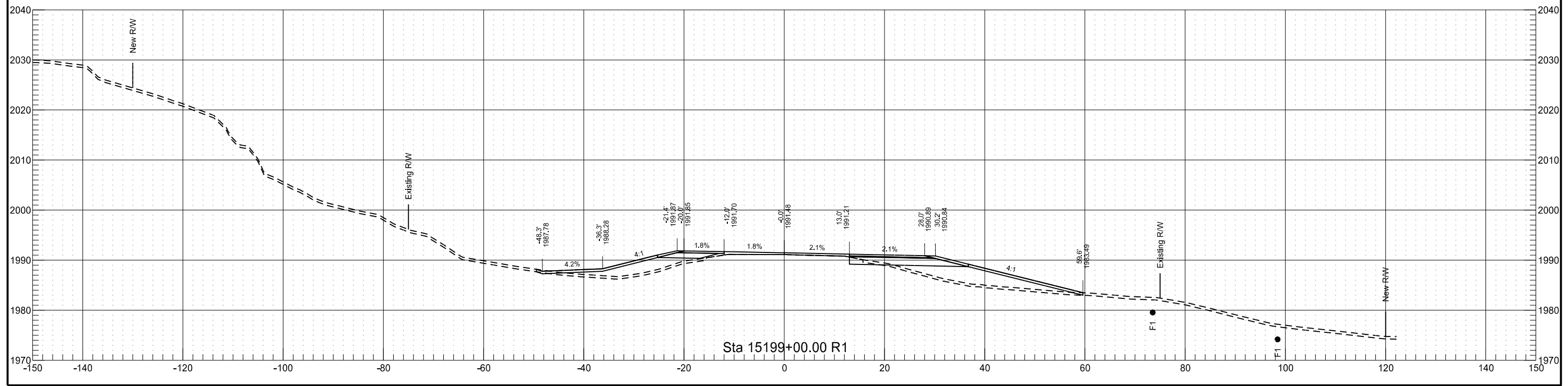
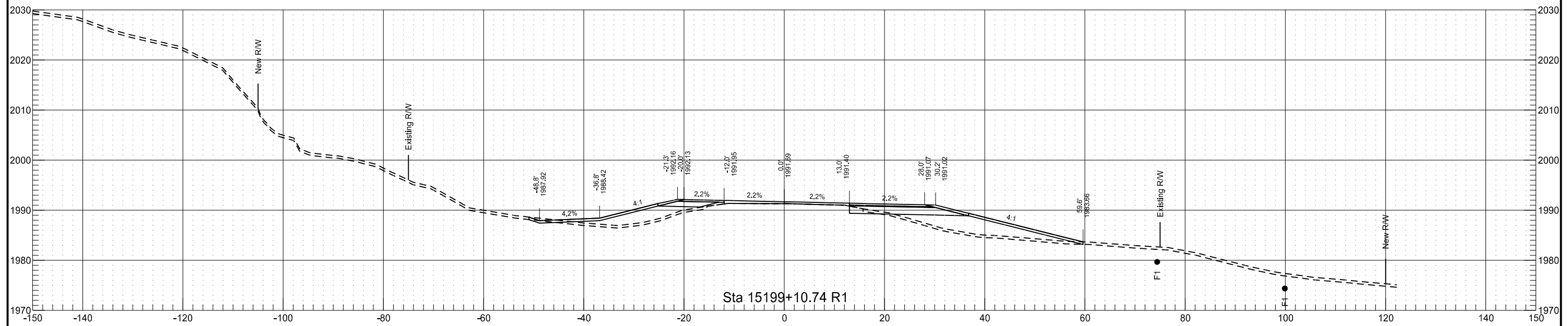

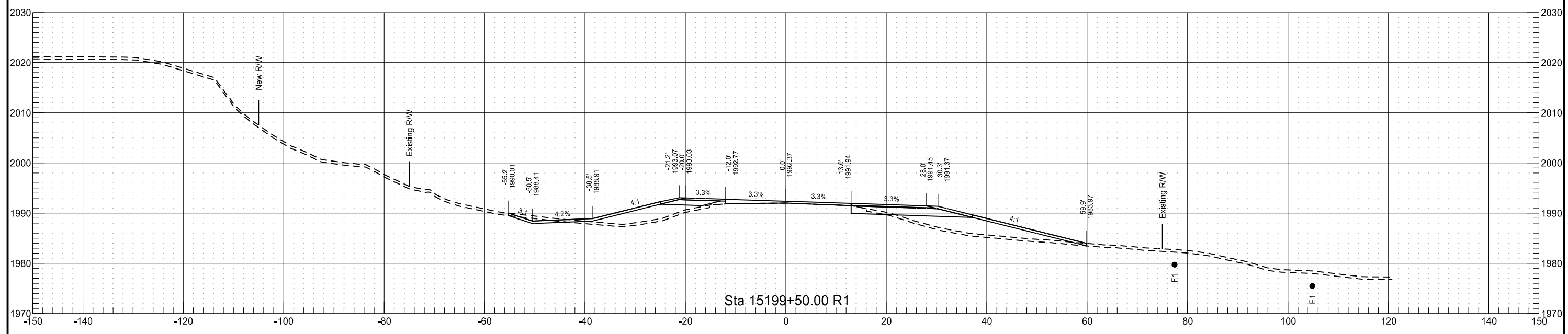
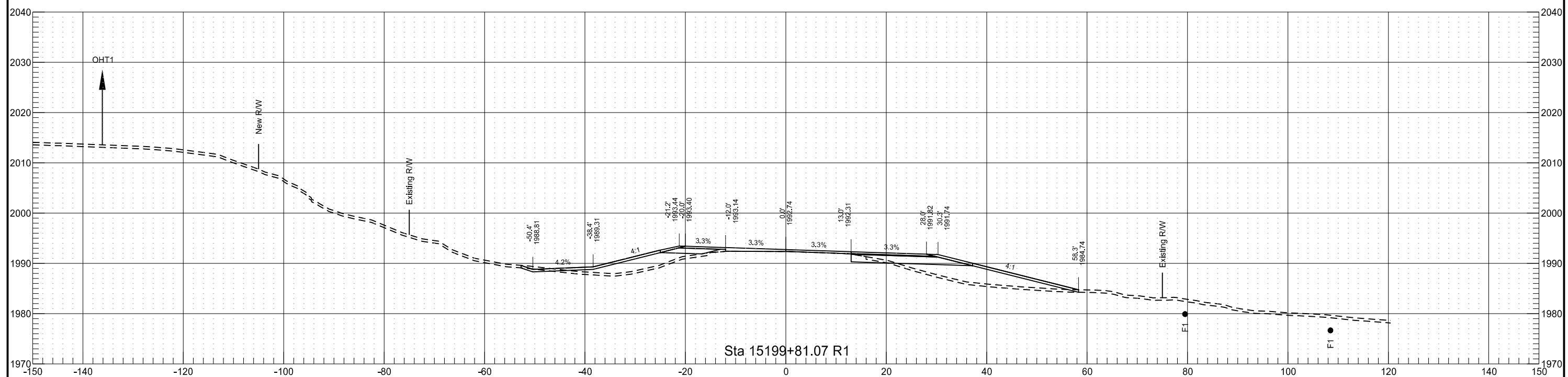

STATE	PROJECT NO.	SECTION NO.	SHEET NO.
ND	SOIB-7-804(061)283	200	105

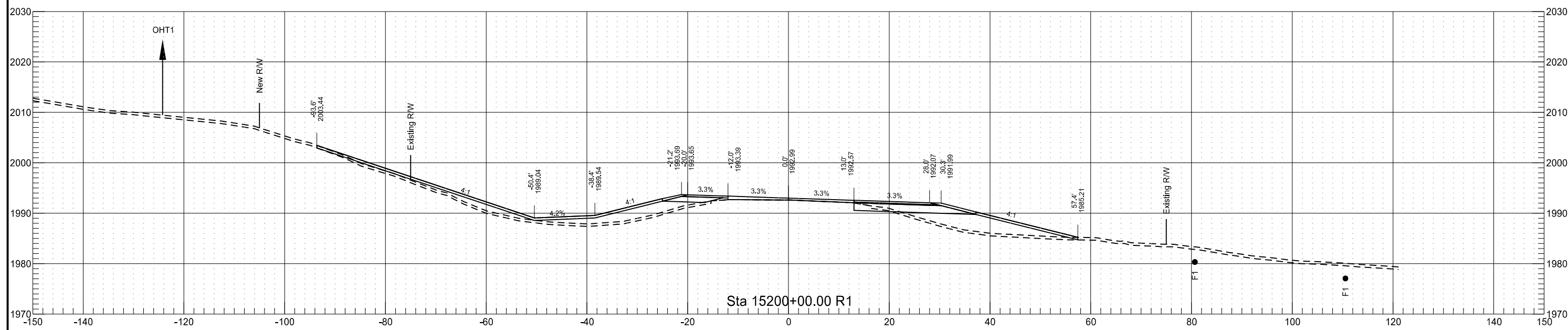
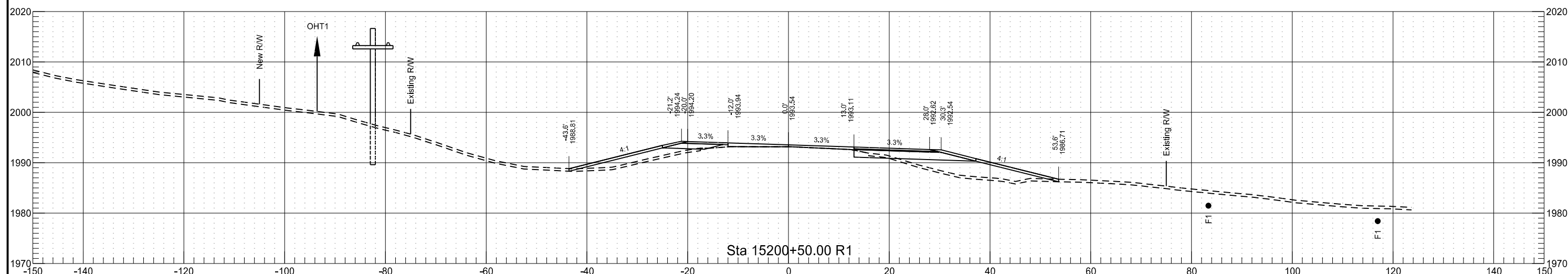
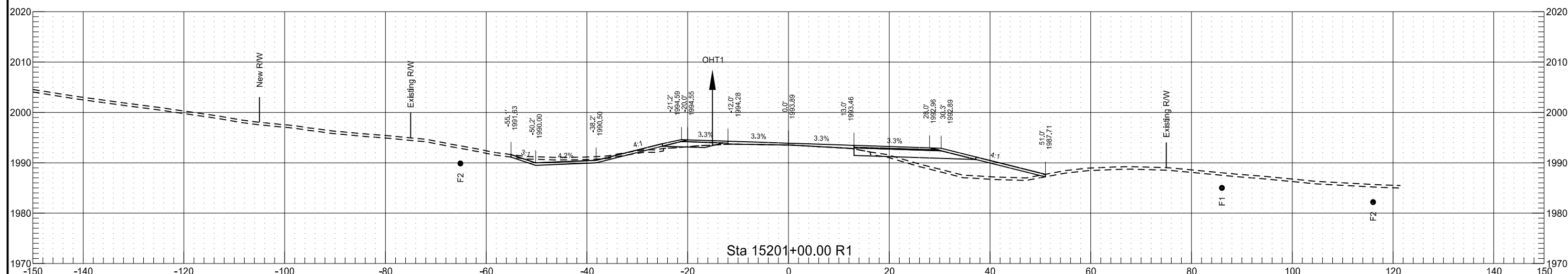

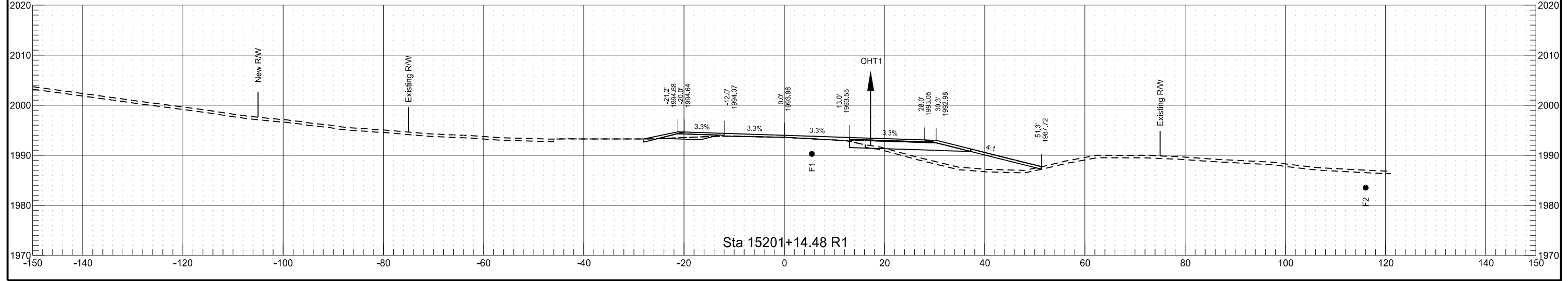
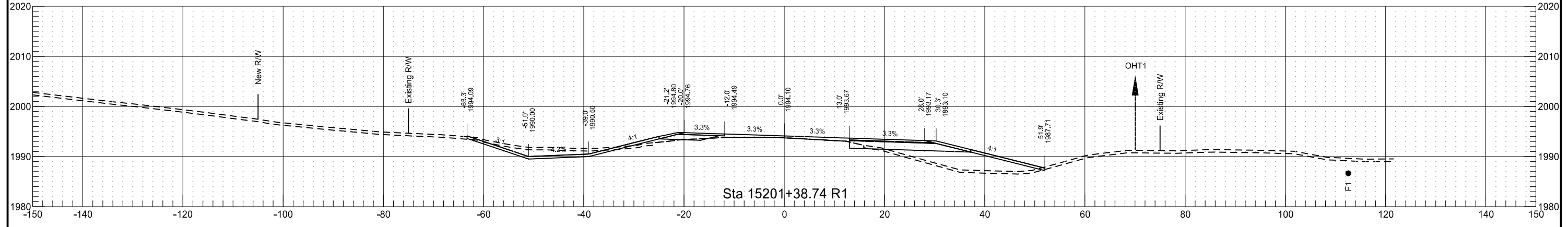
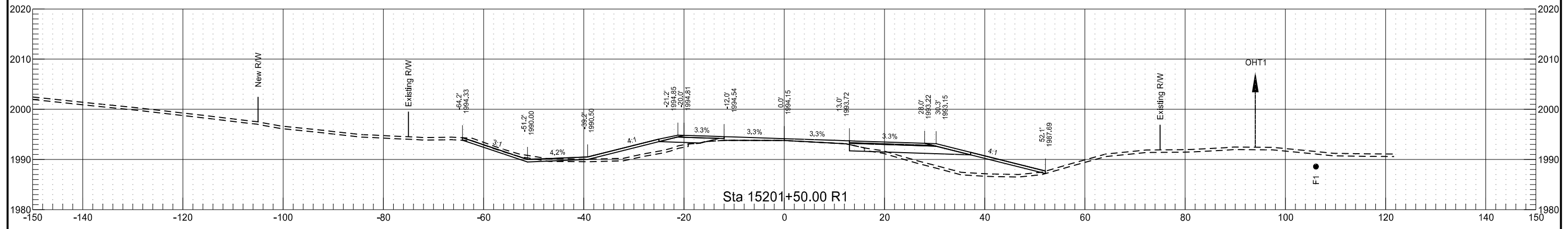

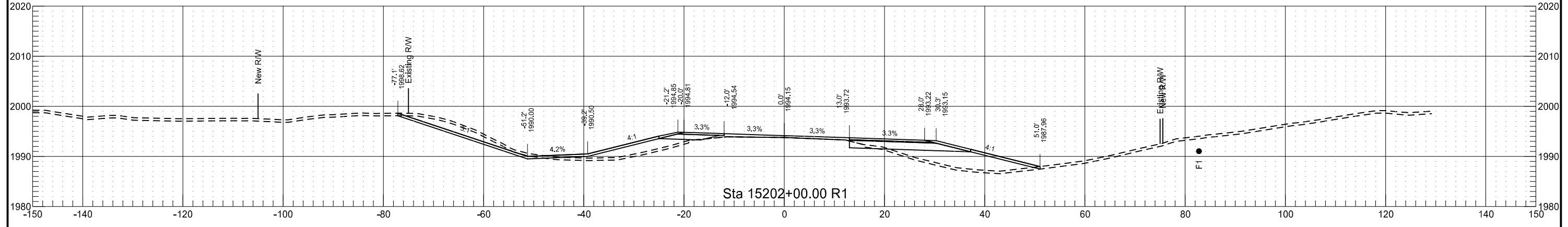
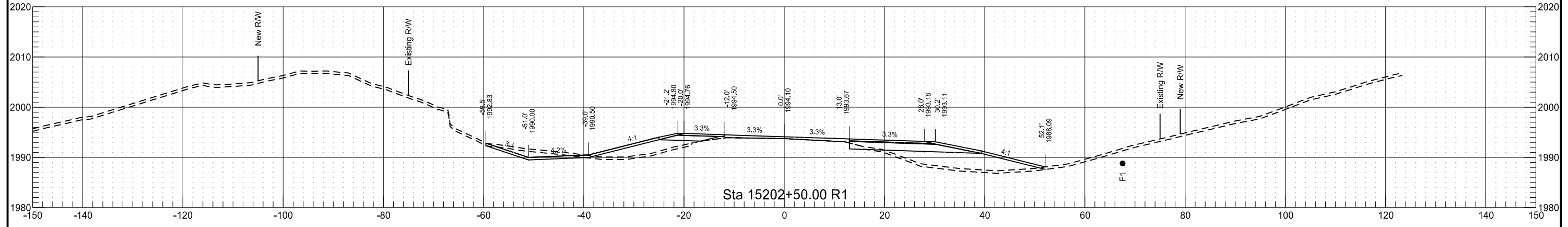
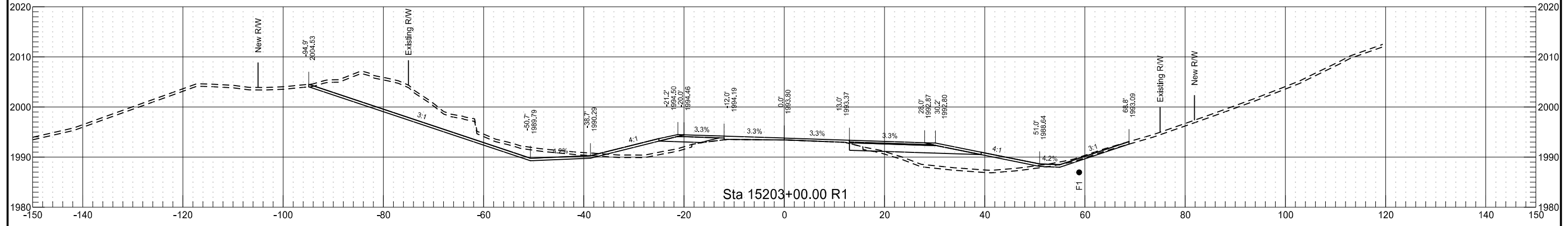
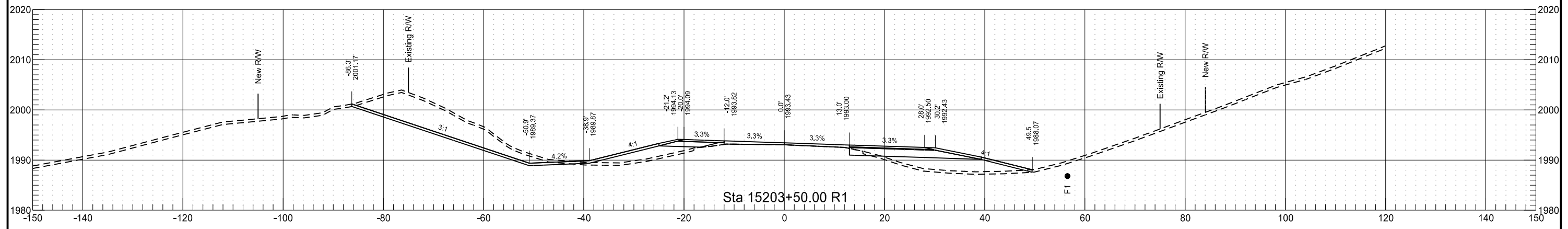

STATE	PROJECT NO.	SECTION NO.	SHEET NO.
ND	SOIB-7-804(061)283	200	108

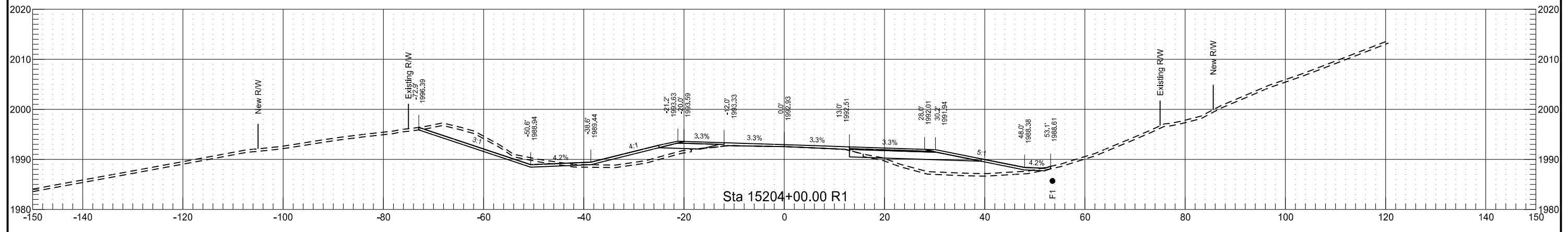
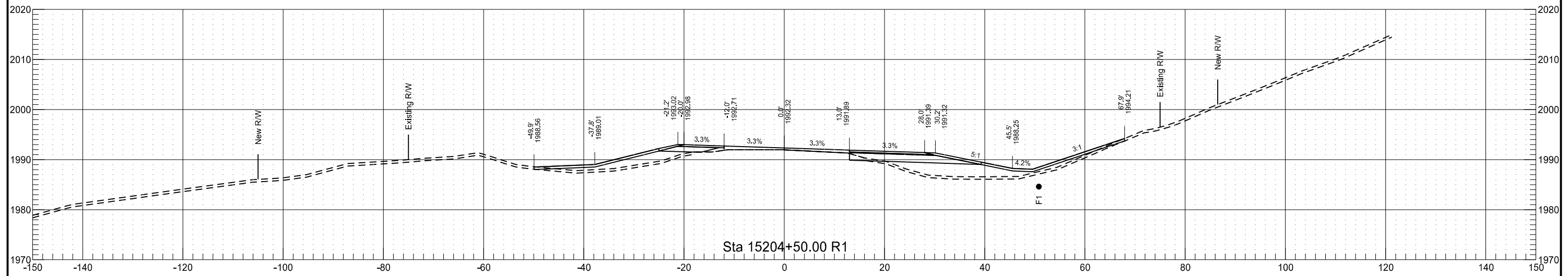
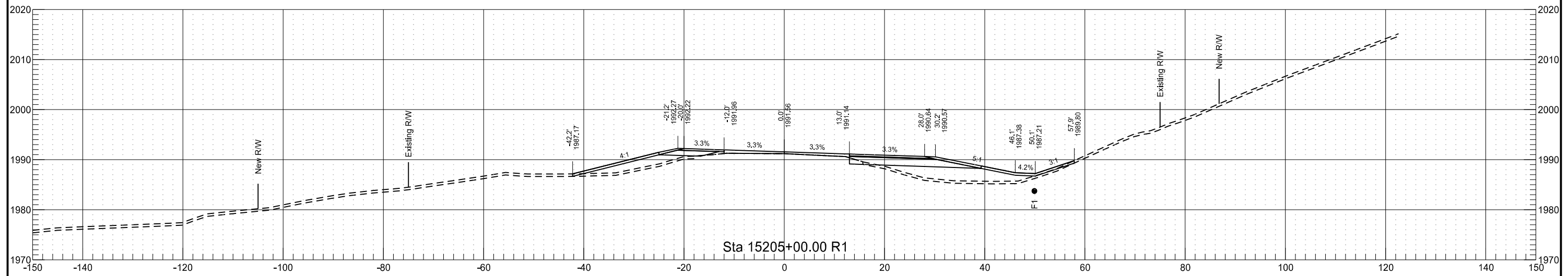

STATE	PROJECT NO.	SECTION NO.	SHEET NO.
ND	SOIB-7-804(061)283	200	109

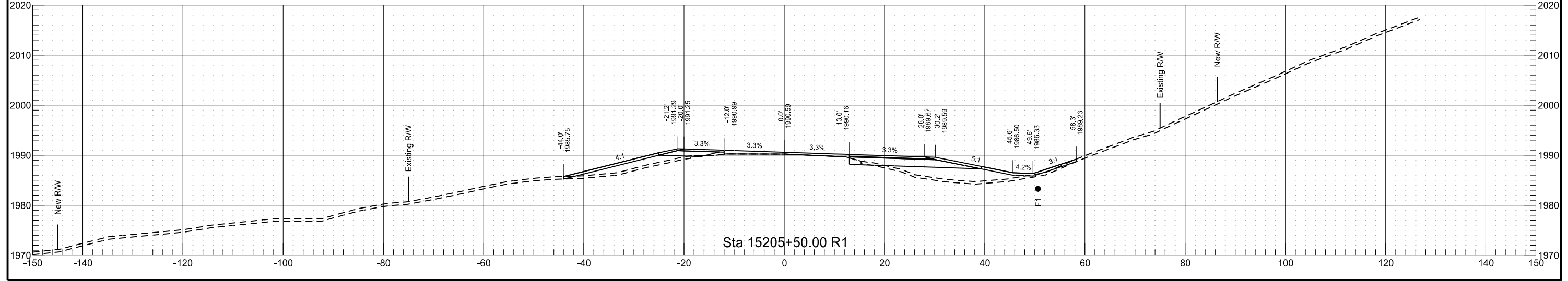
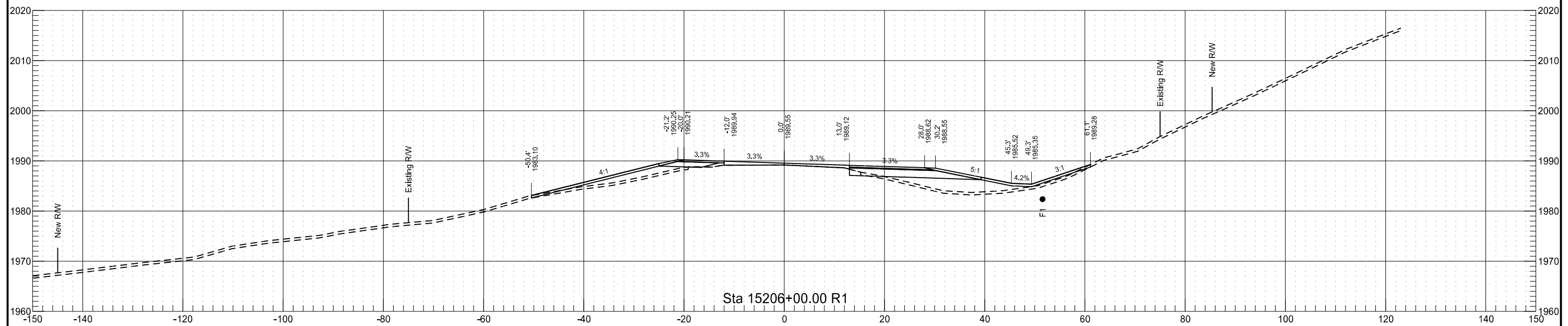
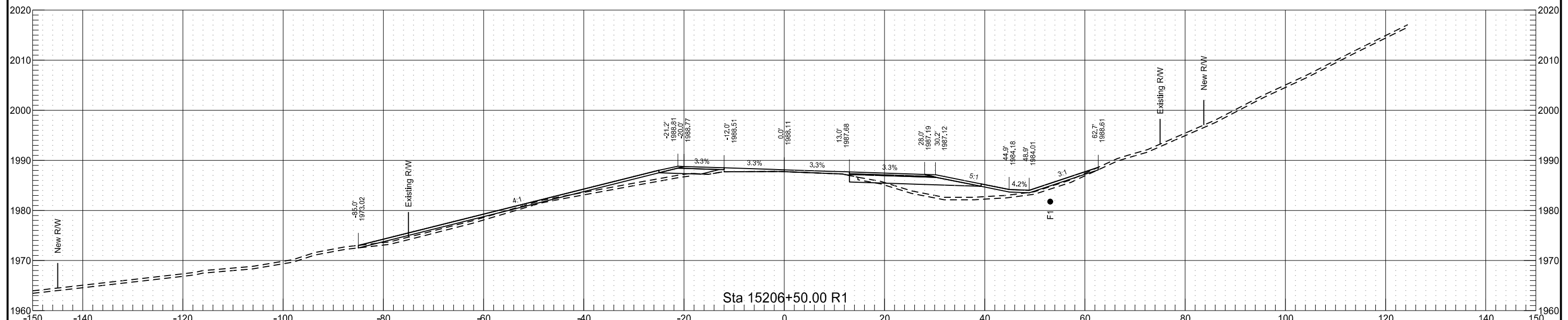

STATE
ND

PROJECT NO.
SOIB-7-804(061)283

SECTION NO.
200

SHEET NO.
110

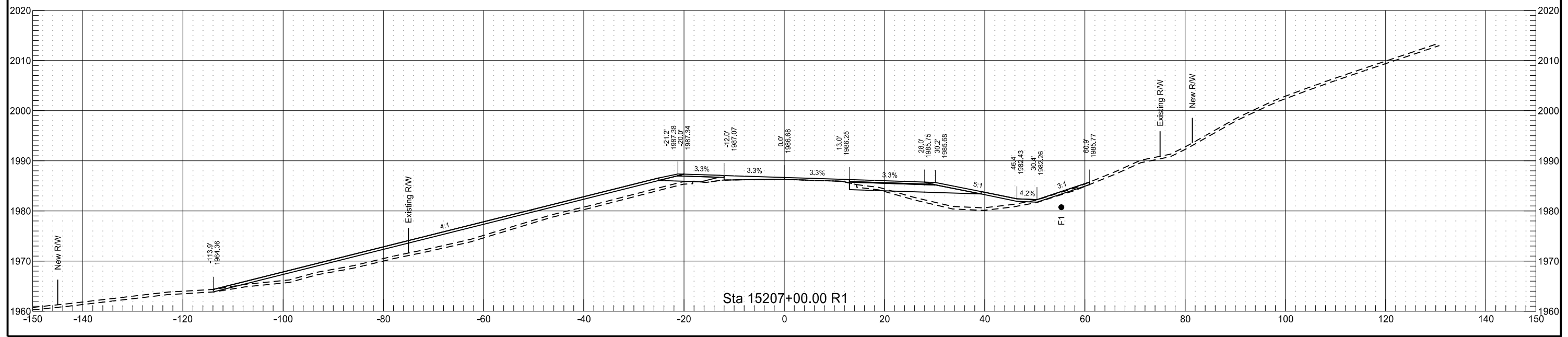
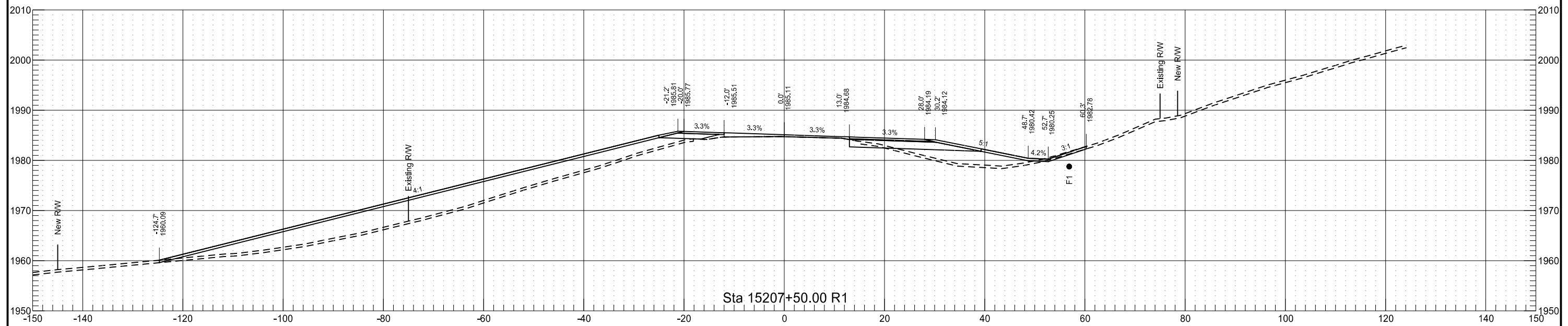
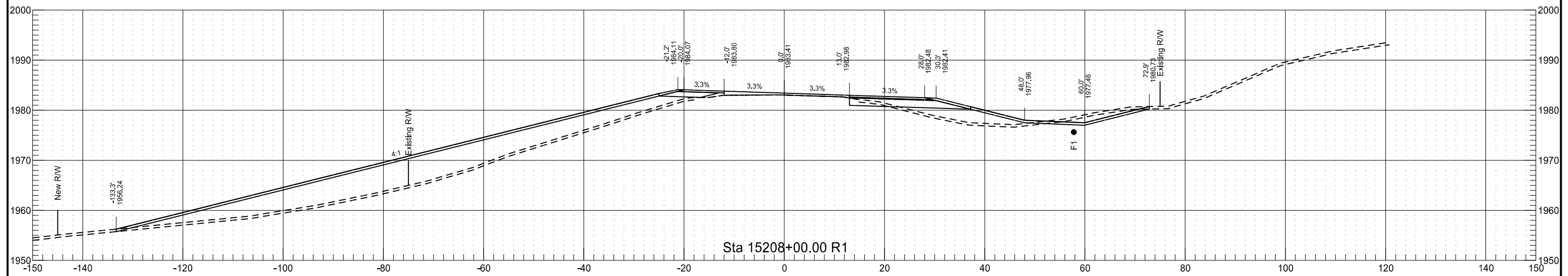

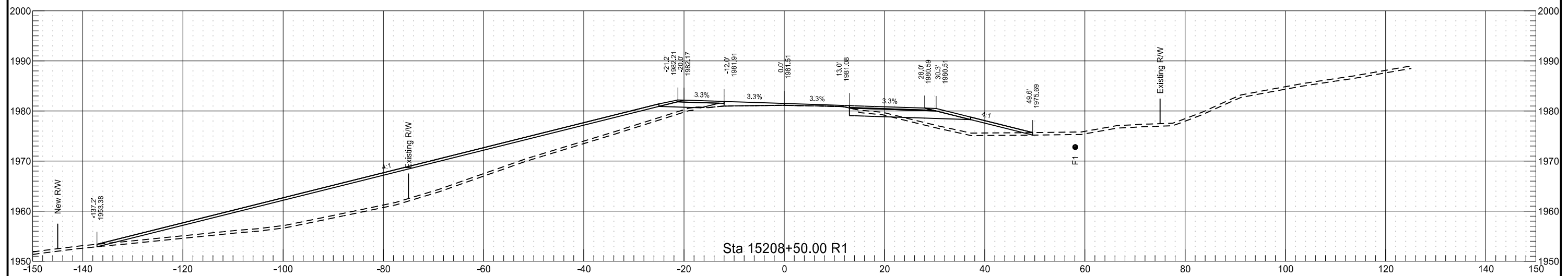
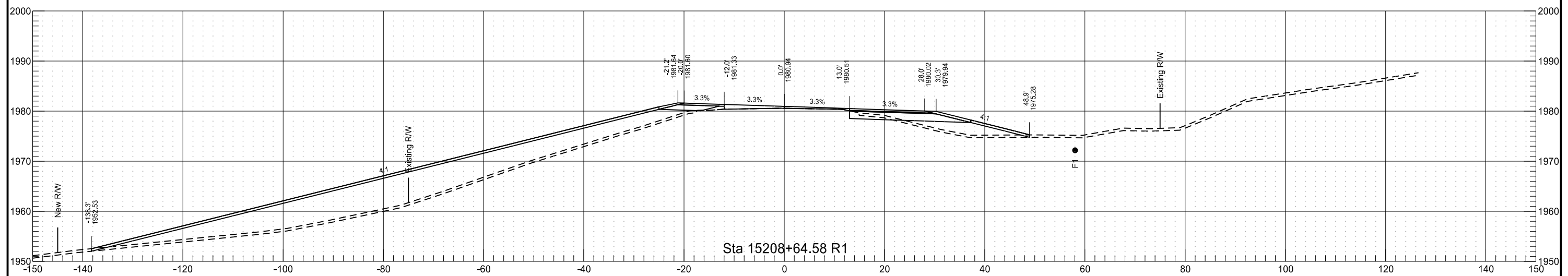
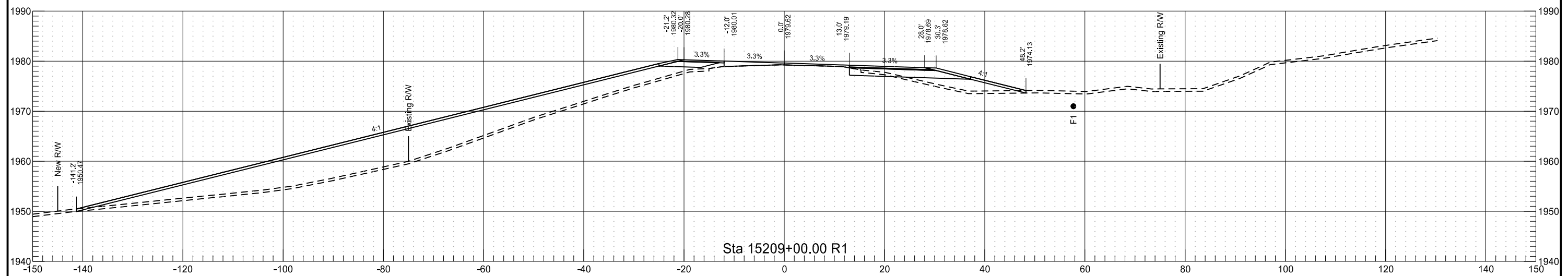

	STATE	PROJECT NO.	SECTION NO.	SHEET NO.
	ND	SOIB-7-804(061)283	200	112

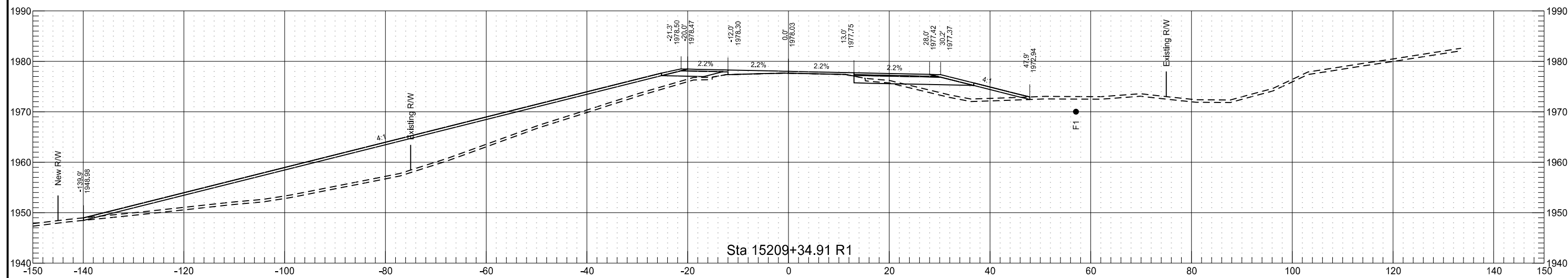
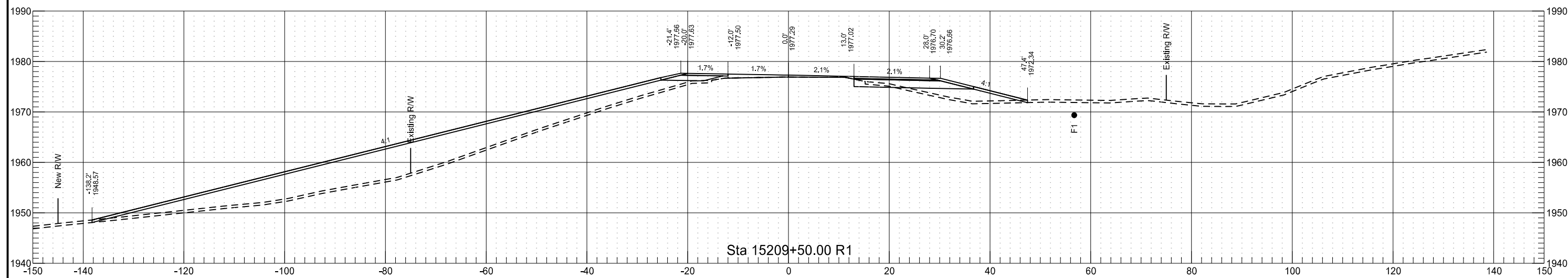
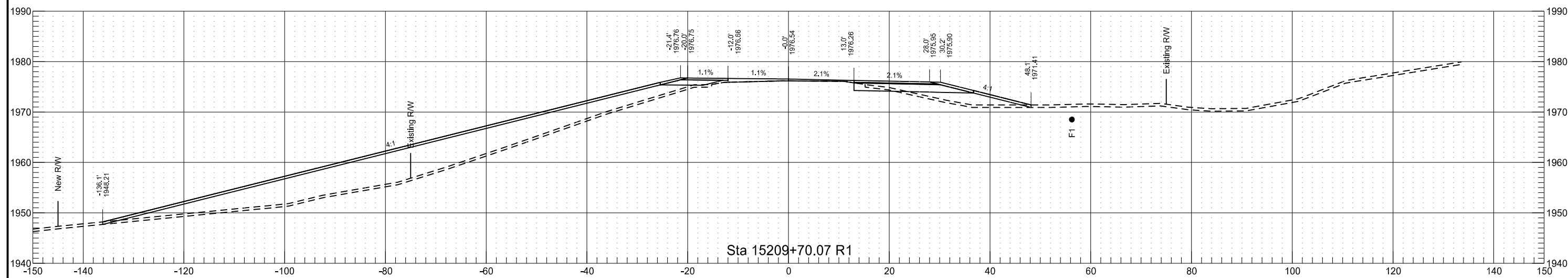

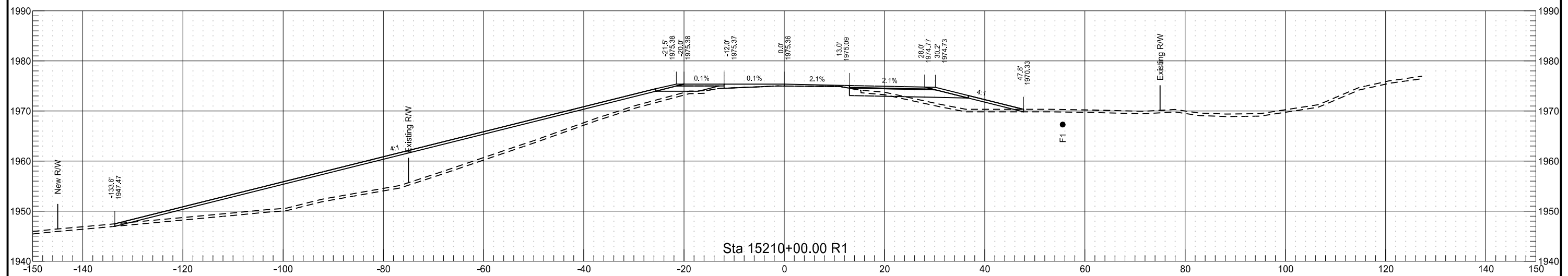
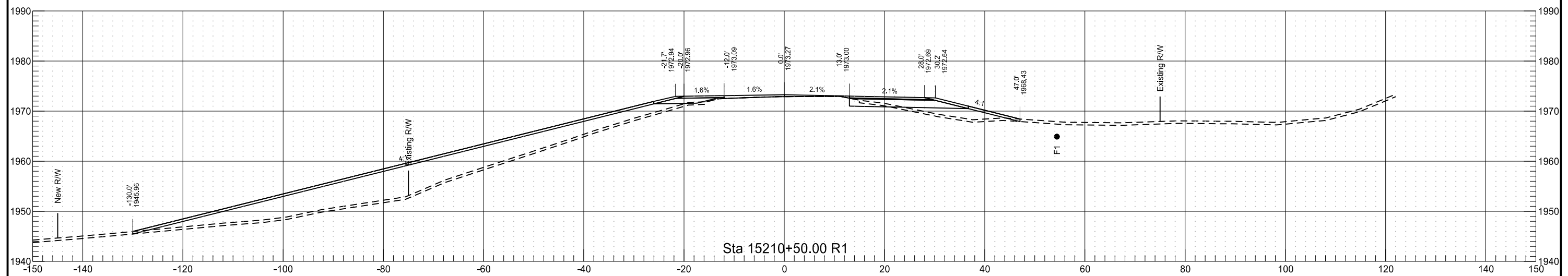
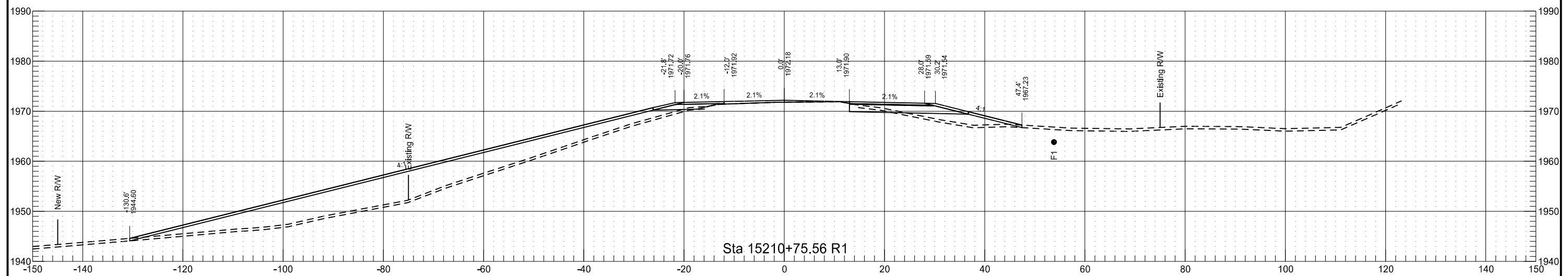

STATE	PROJECT NO.	SECTION NO.	SHEET NO.
ND	SOIB-7-804(061)283	200	114

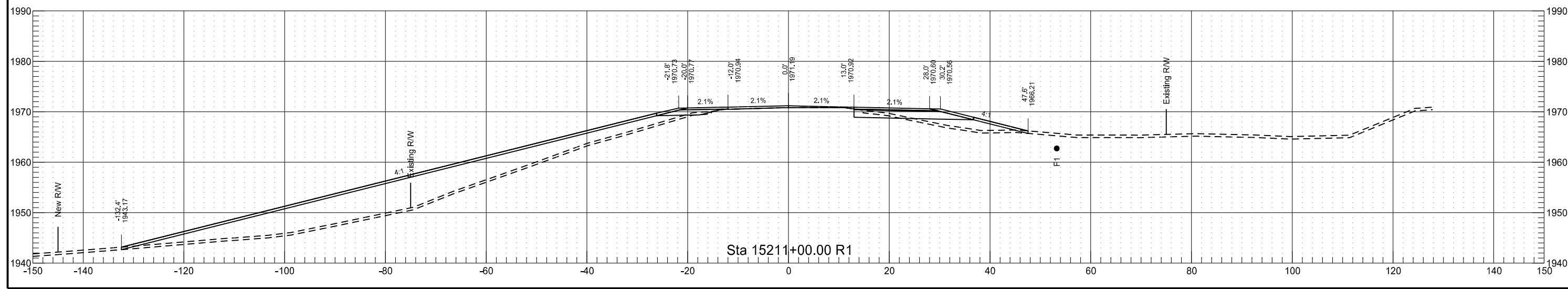
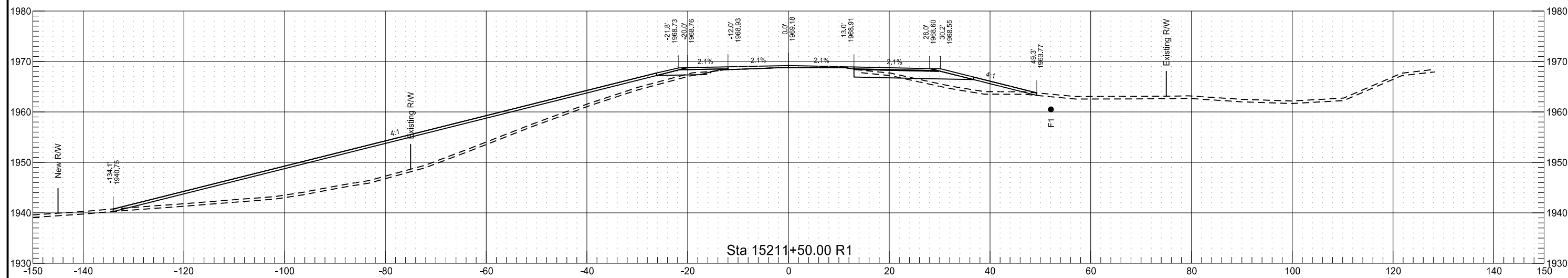
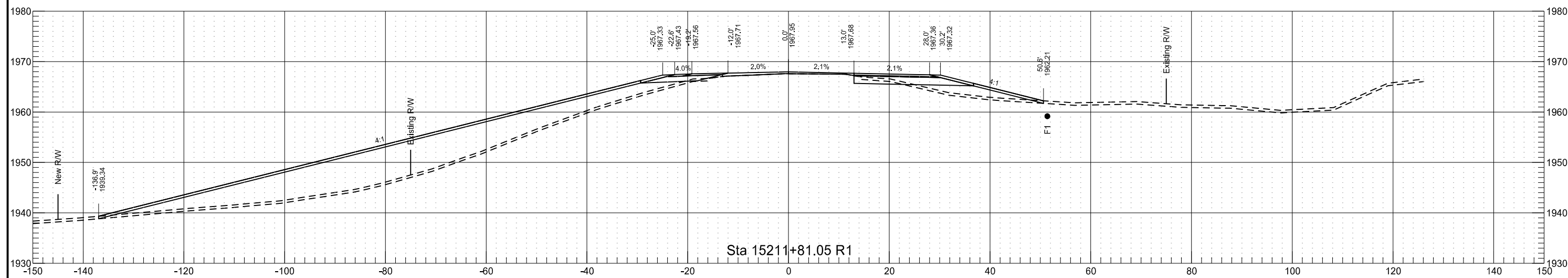

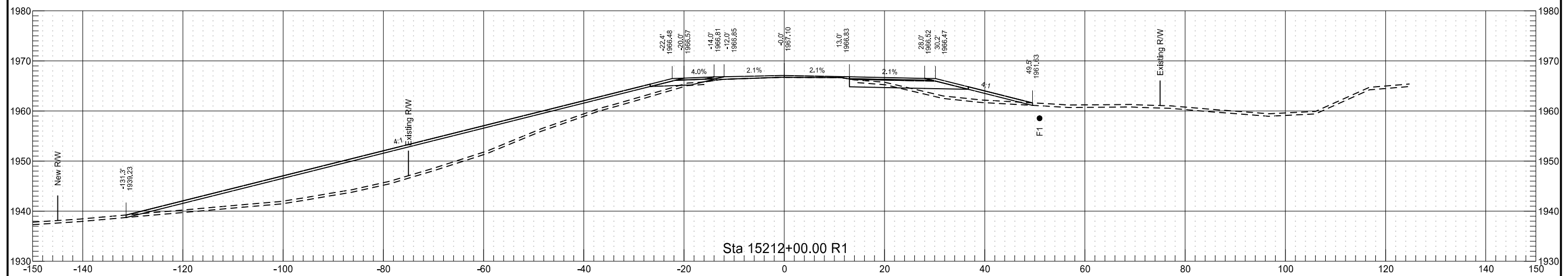
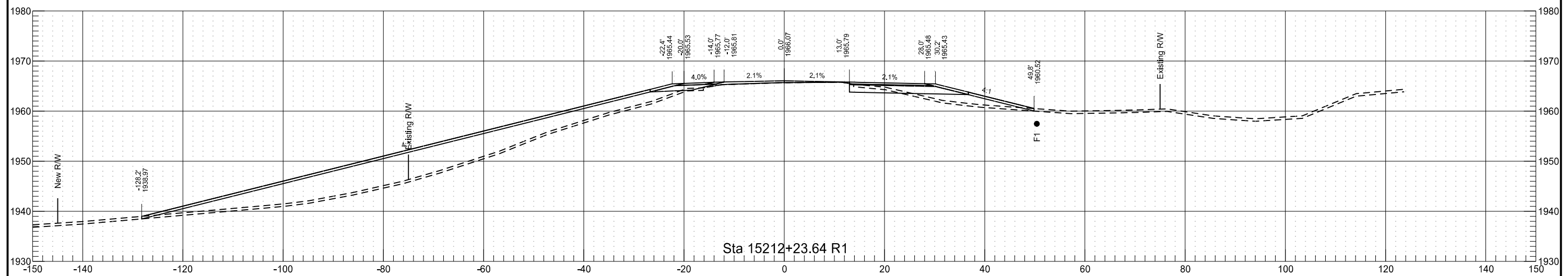
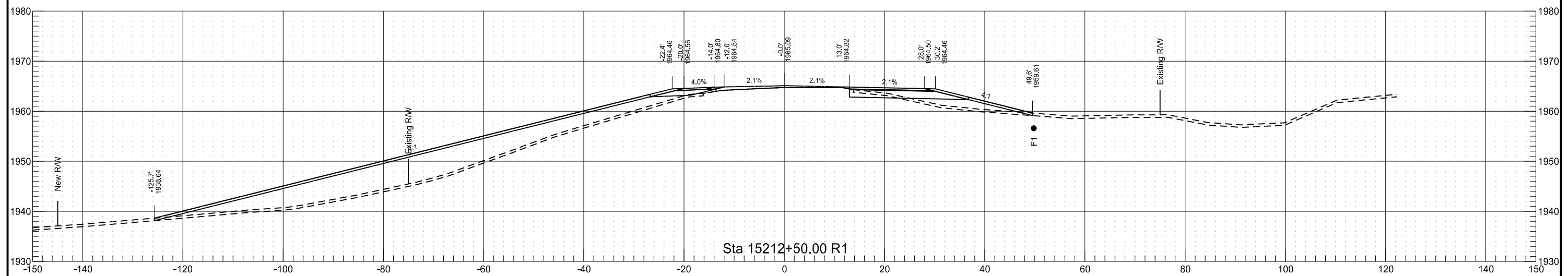

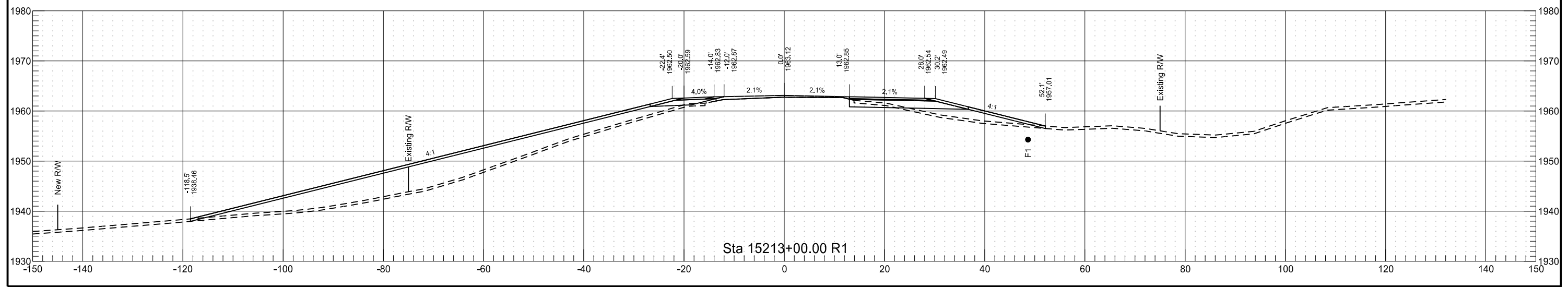
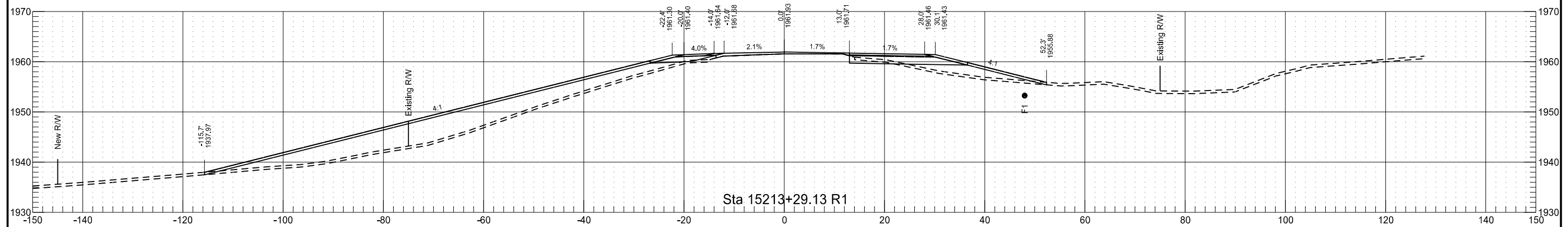
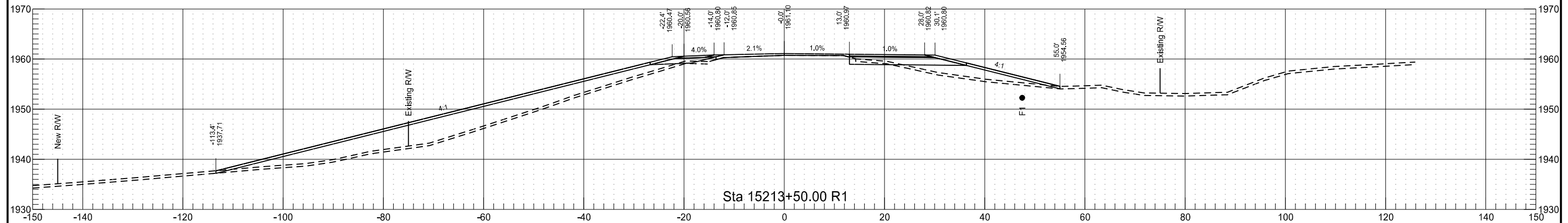

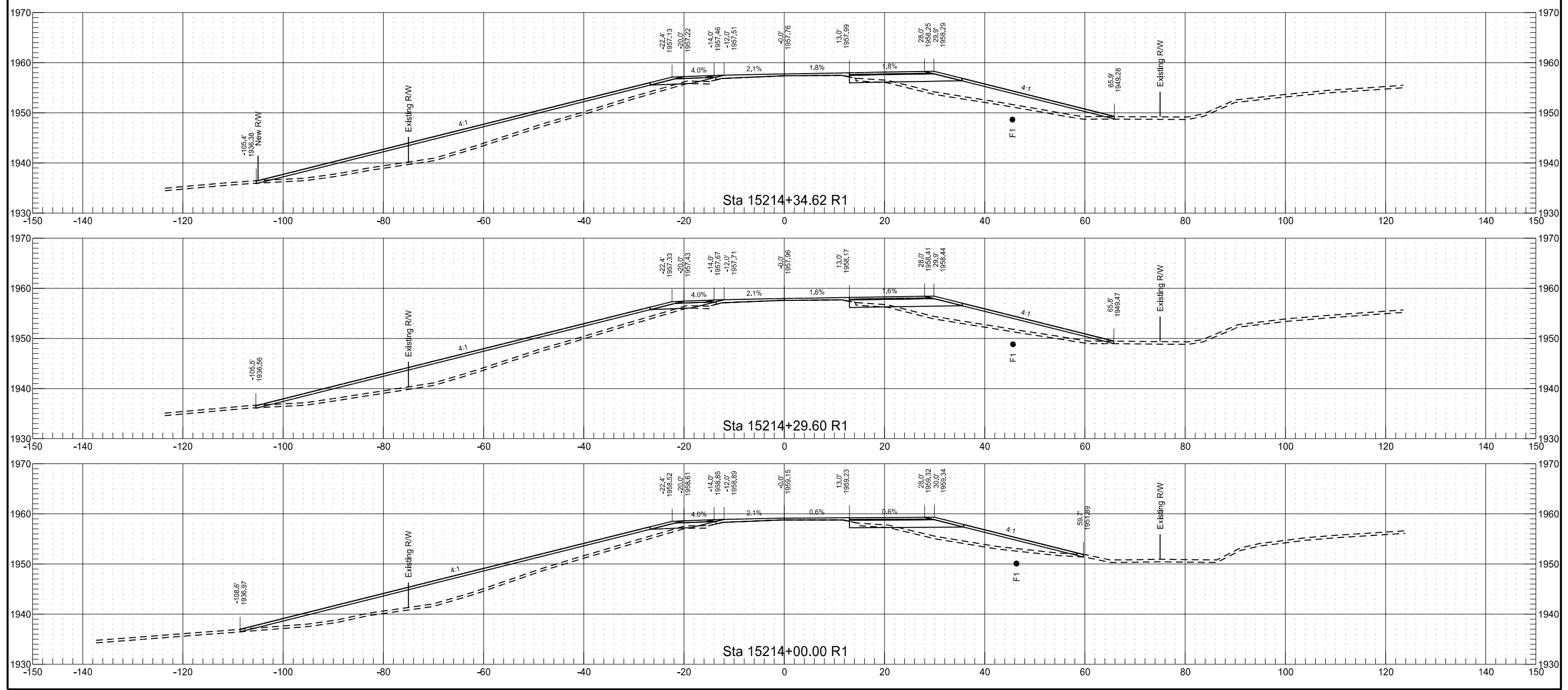

STATE	PROJECT NO.	SECTION NO.	SHEET NO.
ND	SOIB-7-804(061)283	200	118

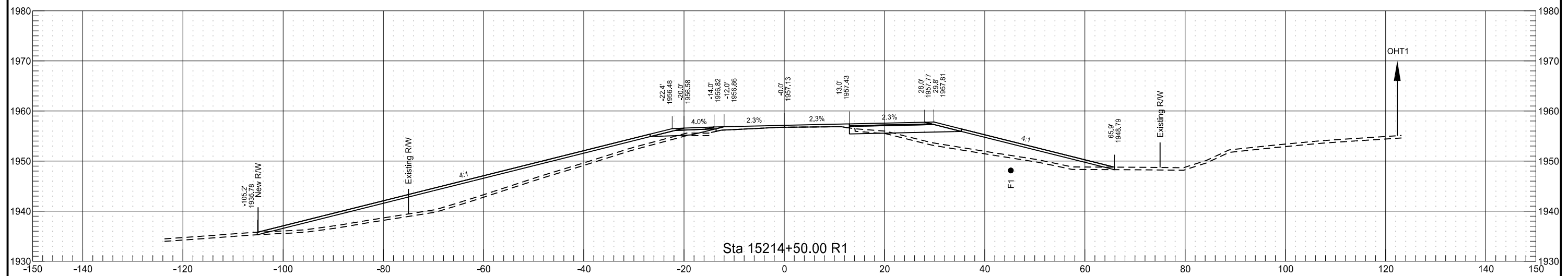
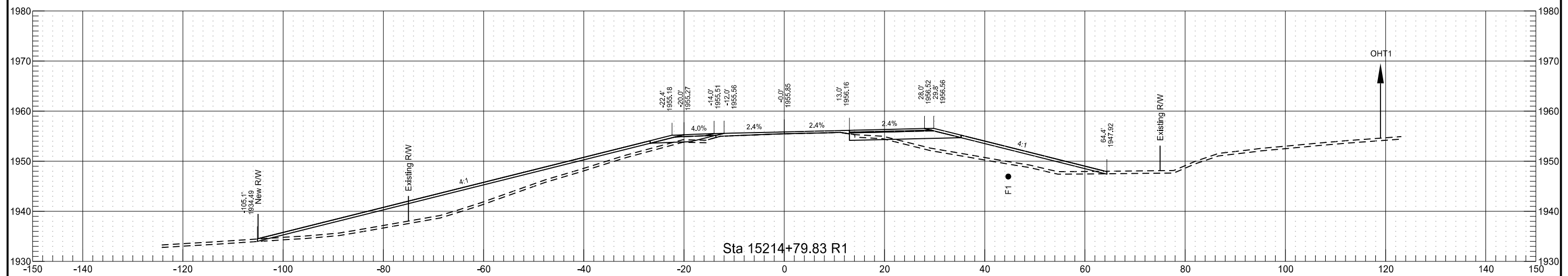
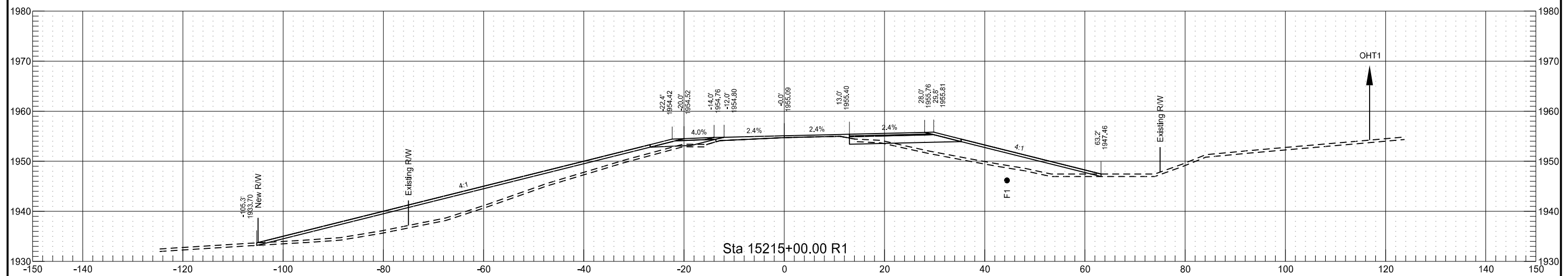

STATE	PROJECT NO.	SECTION NO.	SHEET NO.
ND	SOIB-7-804(061)283	200	119

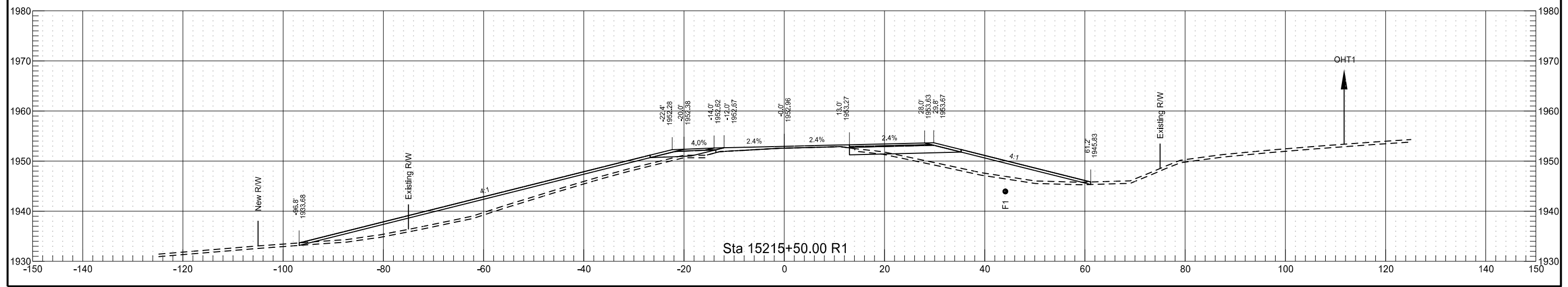
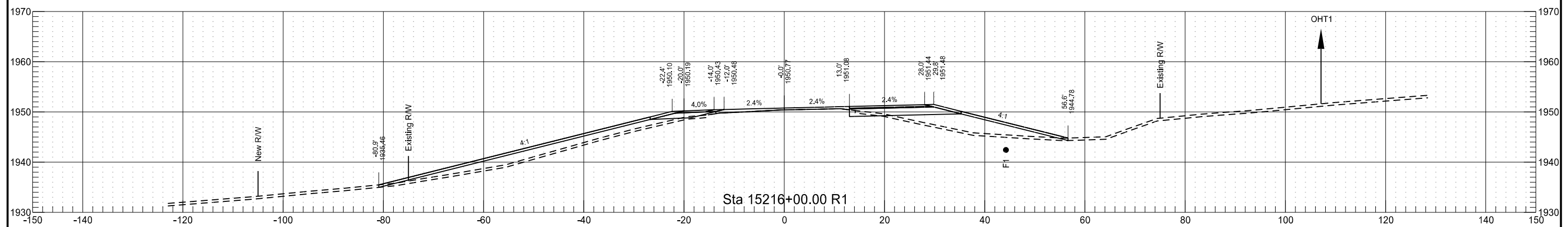
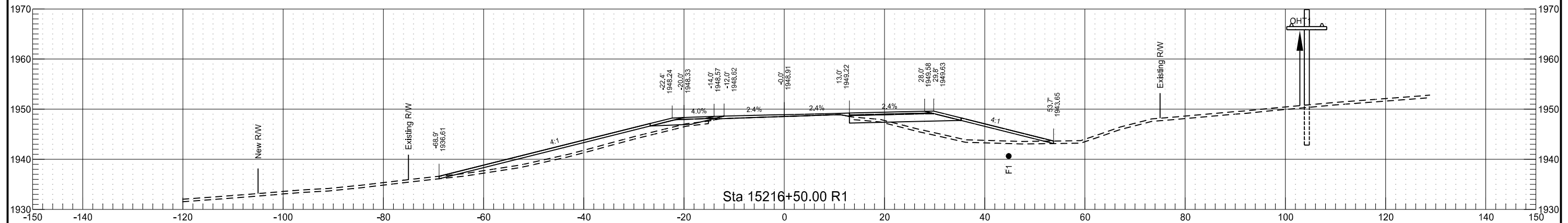

STATE	PROJECT NO.	SECTION NO.	SHEET NO.
ND	SOIB-7-804(061)283	200	120

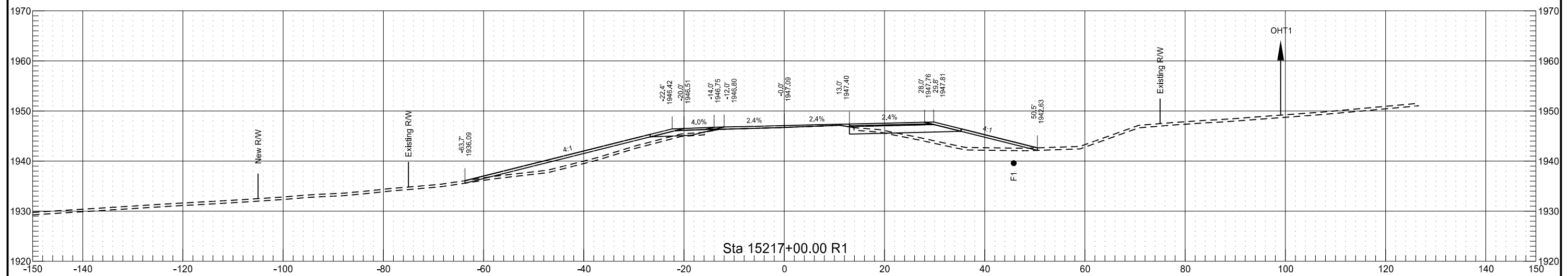
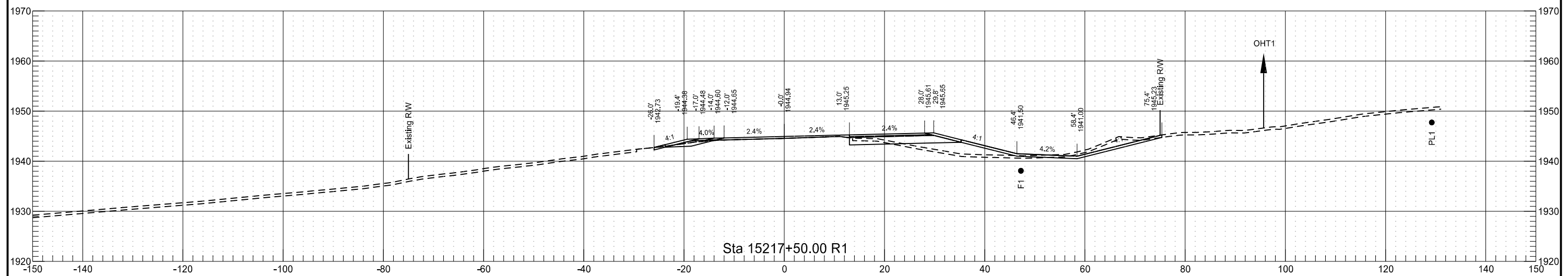
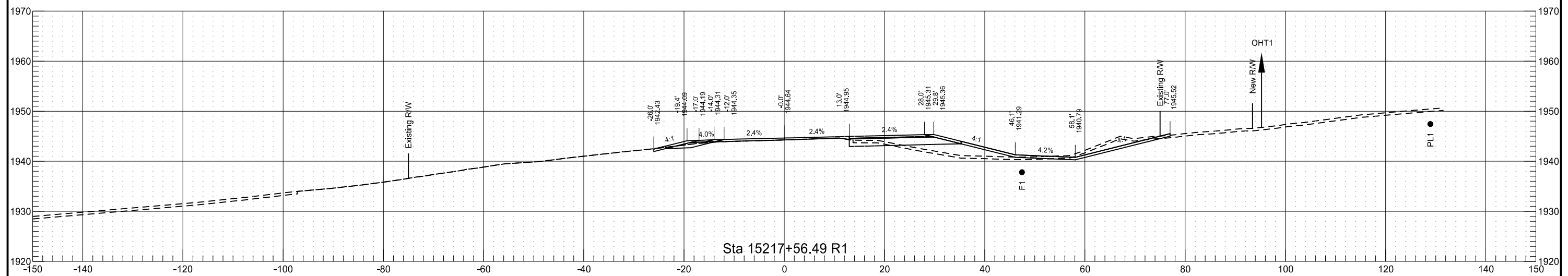

STATE	PROJECT NO.	SECTION NO.	SHEET NO.
ND	SOIB-7-804(061)283	200	121

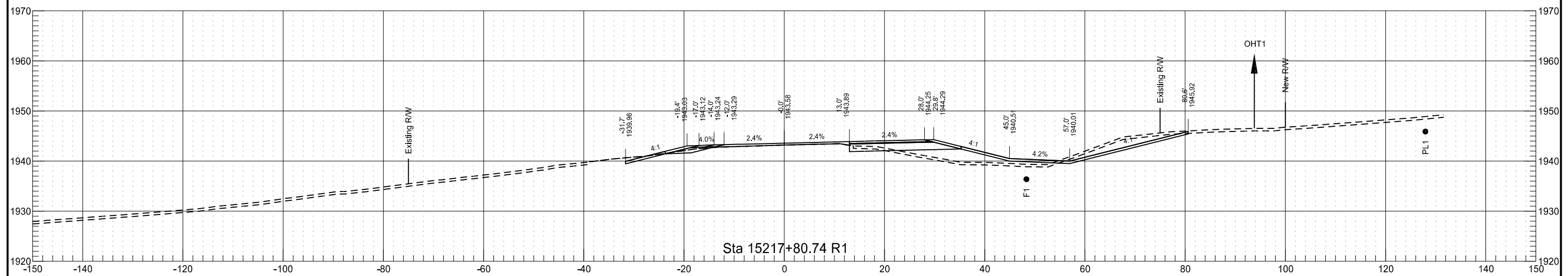
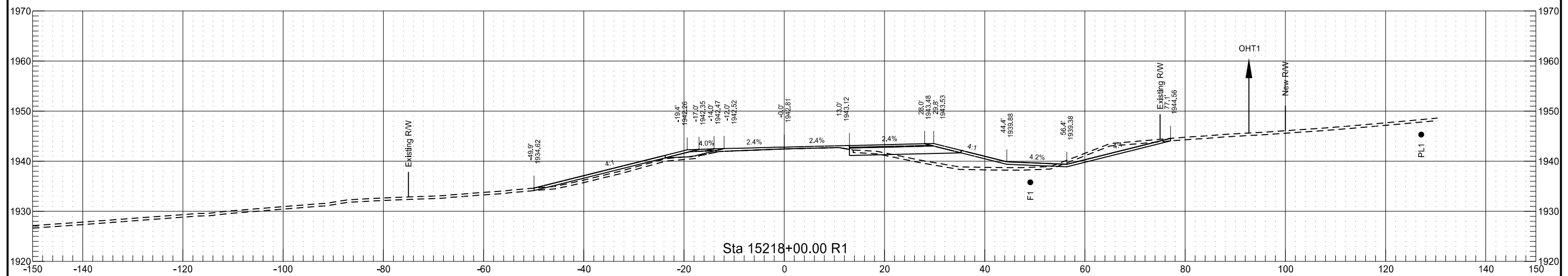
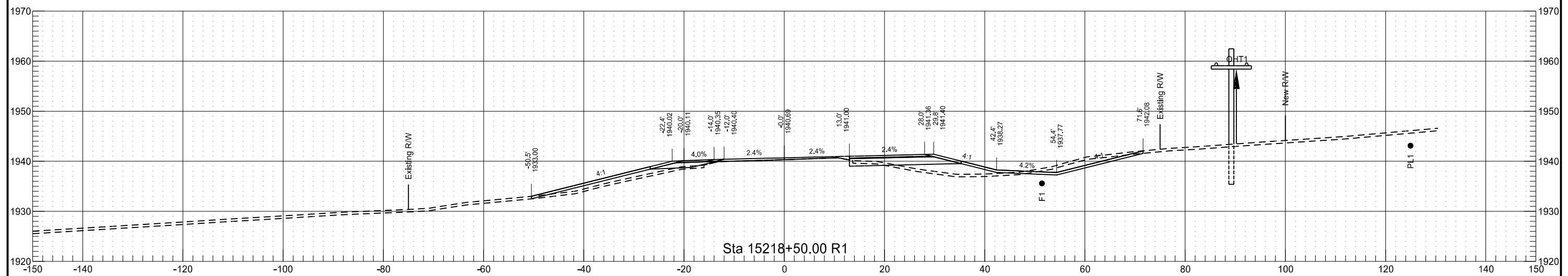

STATE	PROJECT NO.	SECTION NO.	SHEET NO.
ND	SOIB-7-804(061)283	200	122

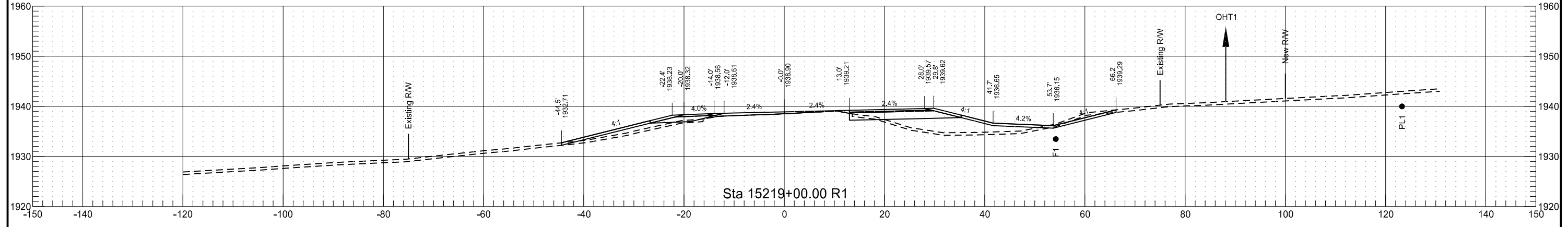
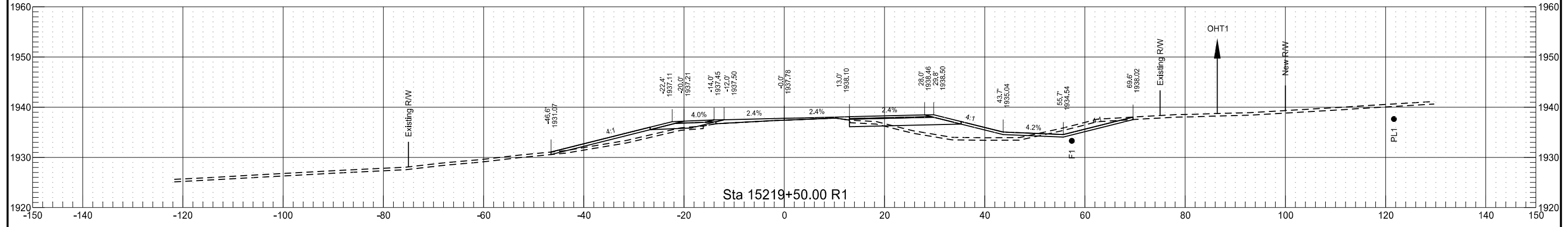
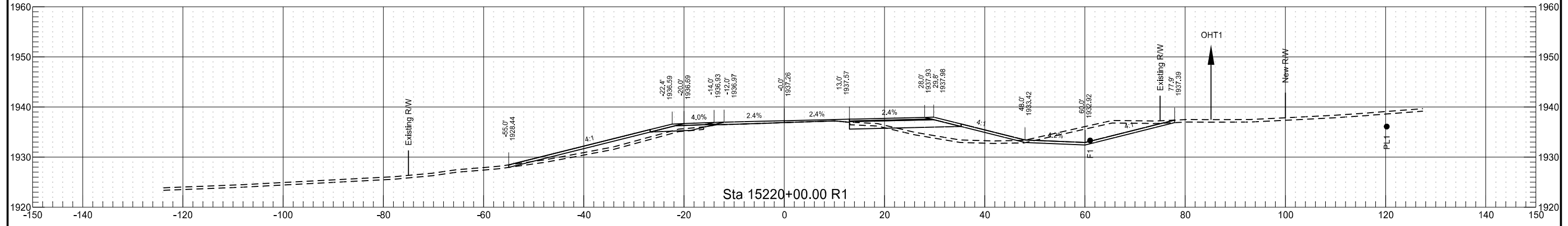
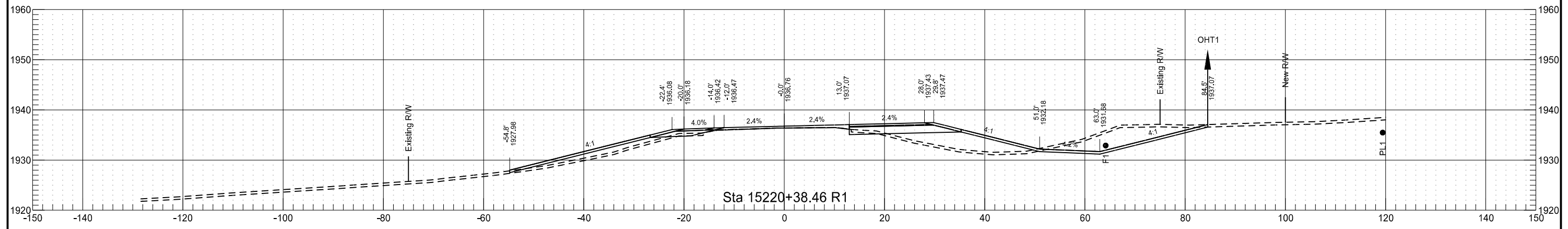

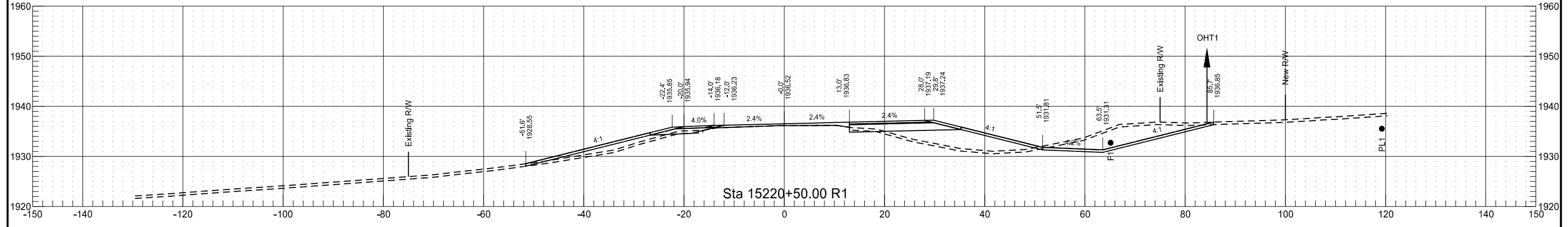
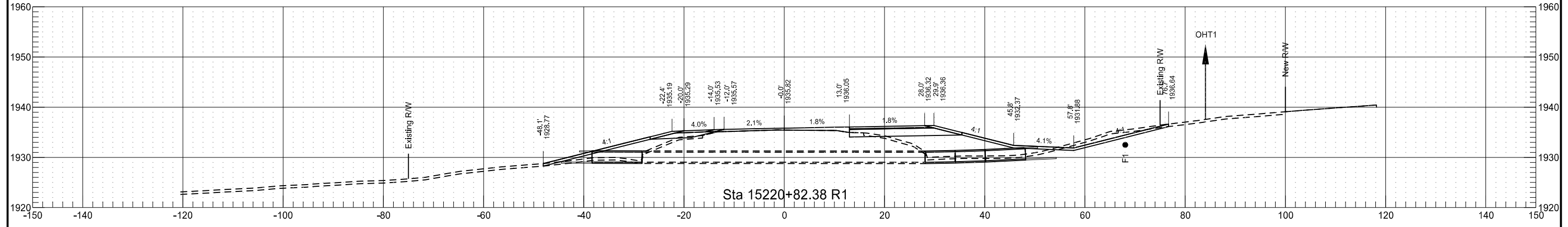
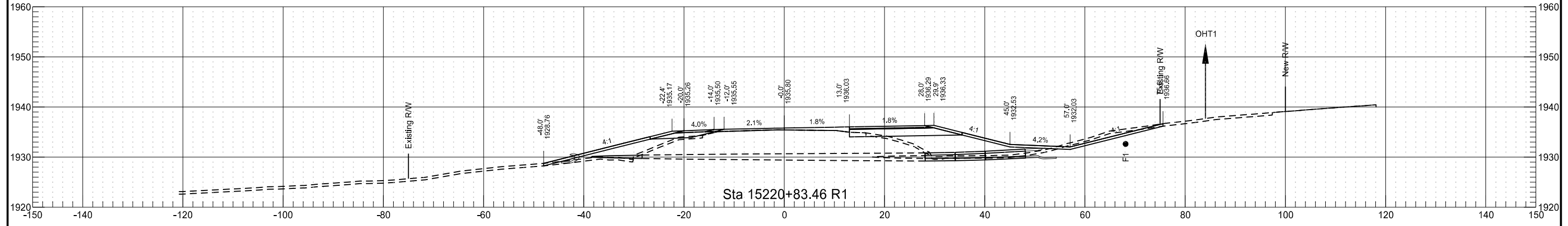
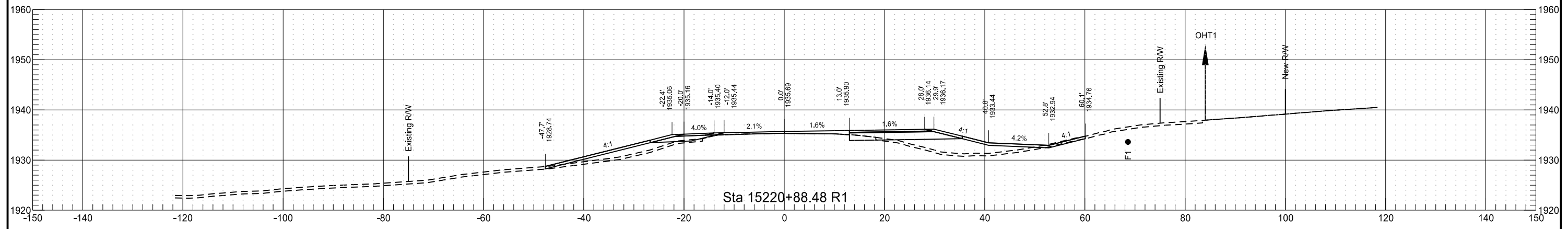

STATE	PROJECT NO.	SECTION NO.	SHEET NO.
ND	SOIB-7-804(061)283	200	124

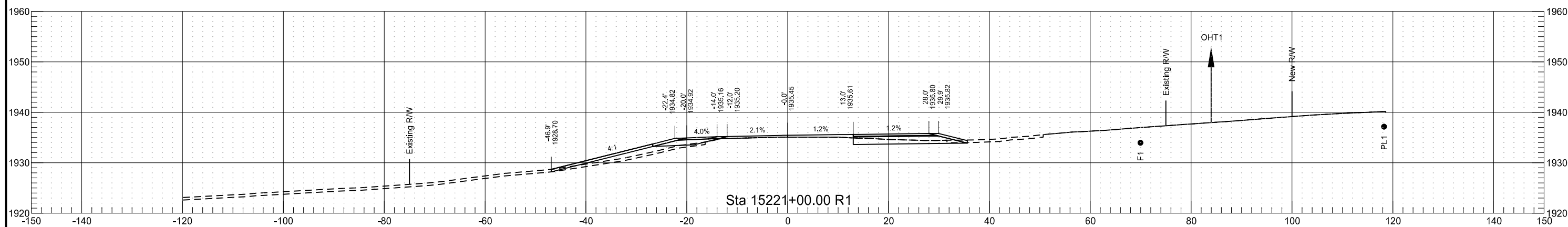
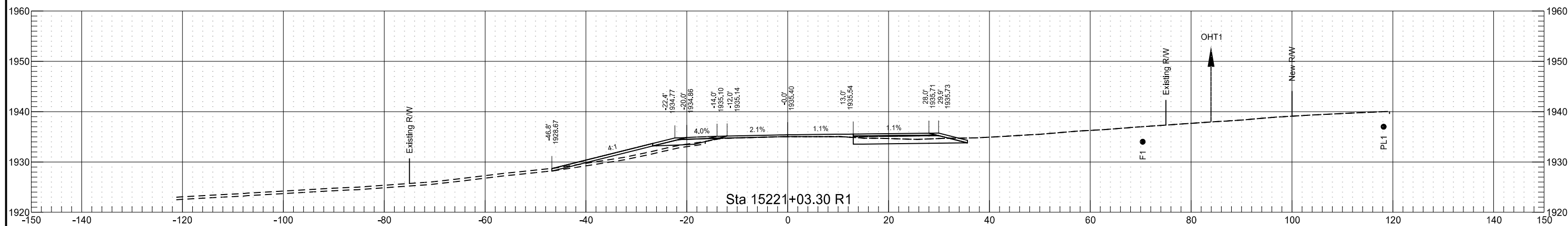
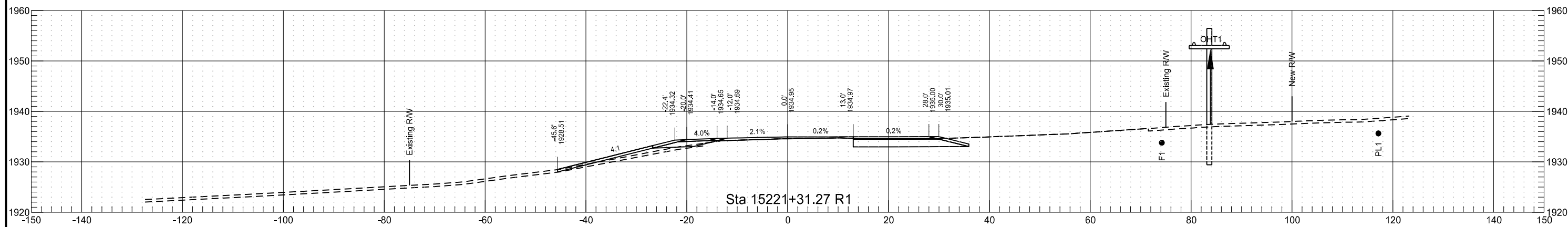
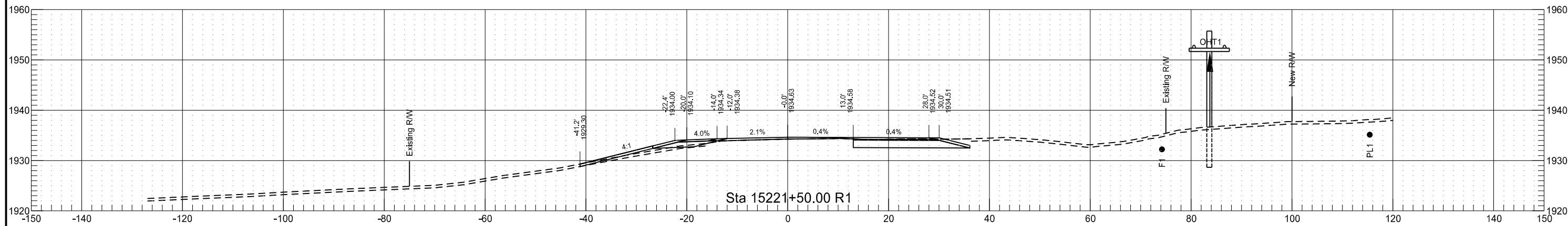

	STATE	PROJECT NO.	SECTION NO.	SHEET NO.
	ND	SOIB-7-804(061)283	200	125

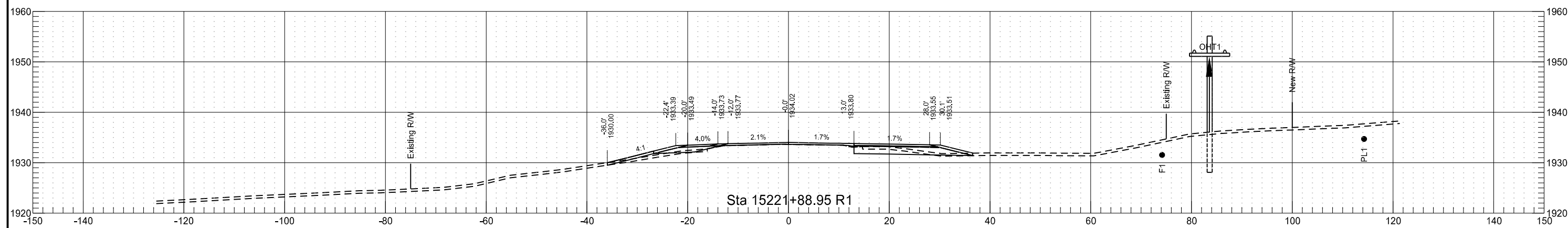
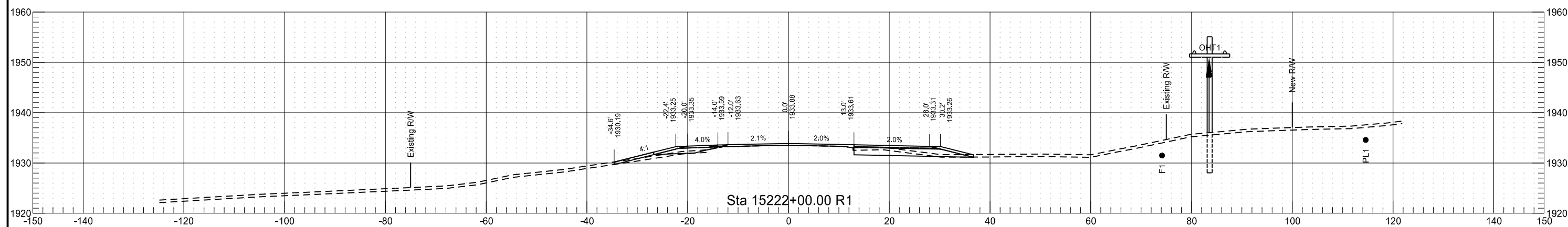
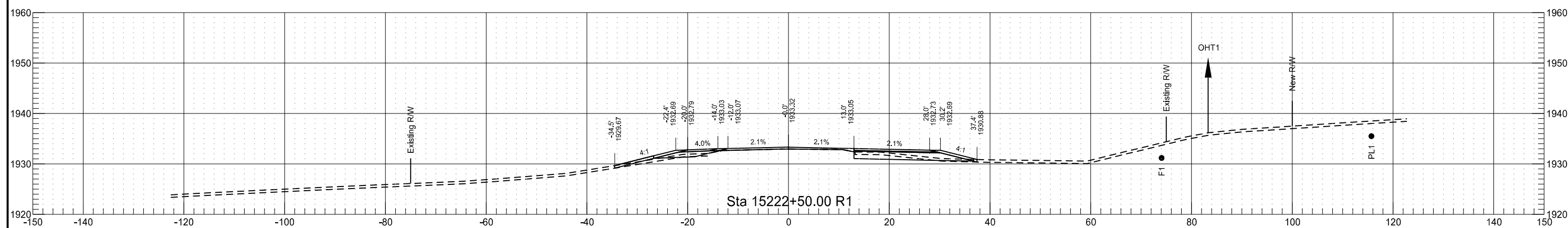
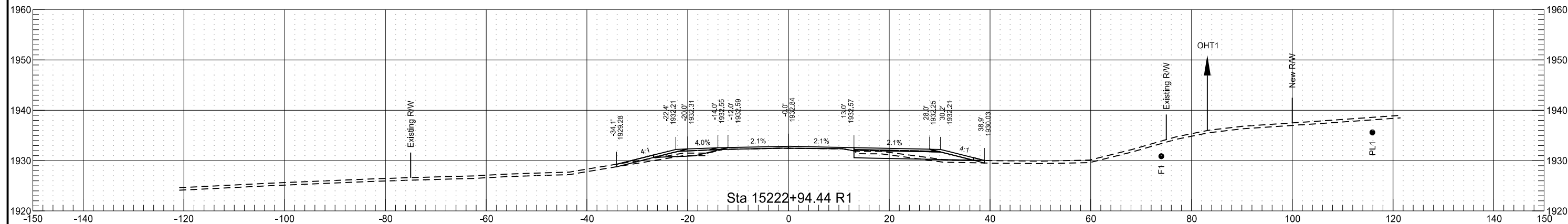

	STATE	PROJECT NO.	SECTION NO.	SHEET NO.
	ND	SOIB-7-804(061)283	200	126

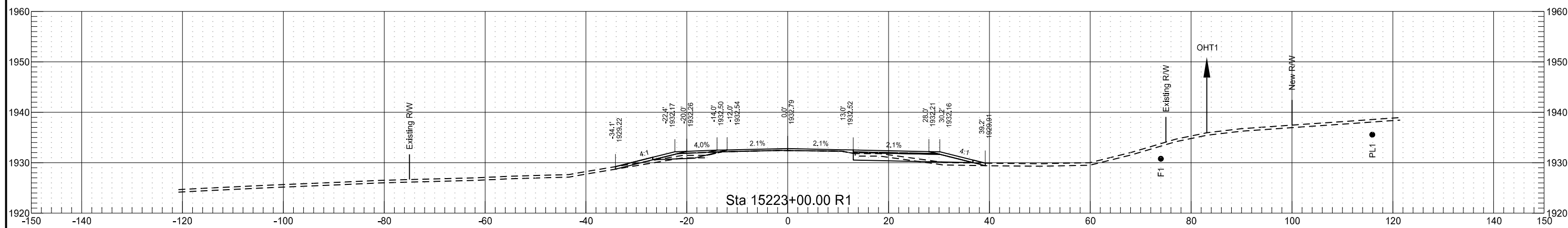
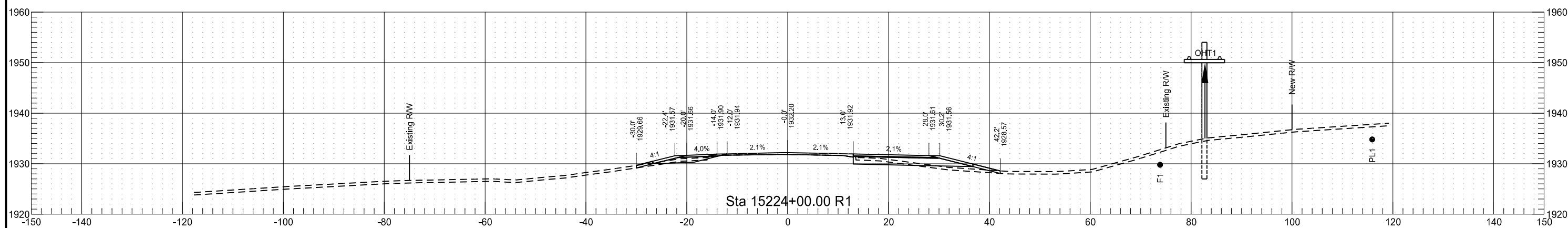
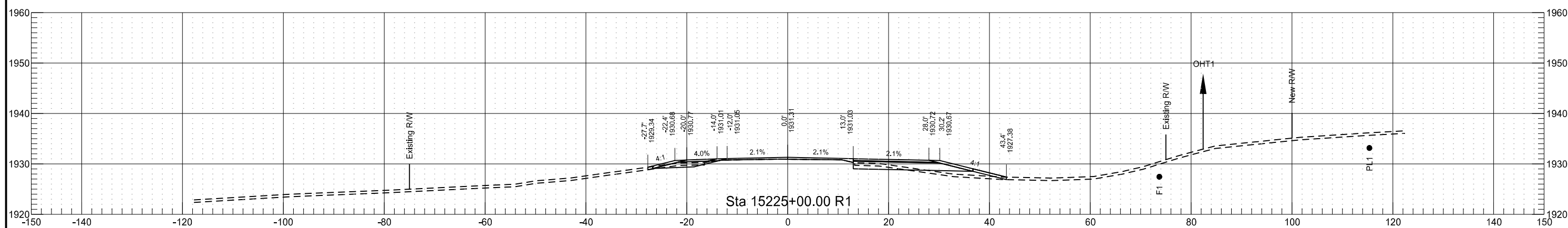
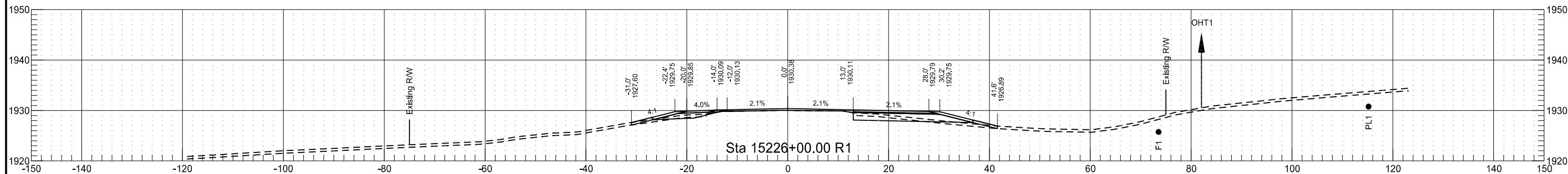

STATE	PROJECT NO.	SECTION NO.	SHEET NO.
ND	SOIB-7-804(061)283	200	127

