

	STATE	PROJECT NO.	SECTION NO.	SHEET NO.
	ND	SU-6-986(121)125	200	1

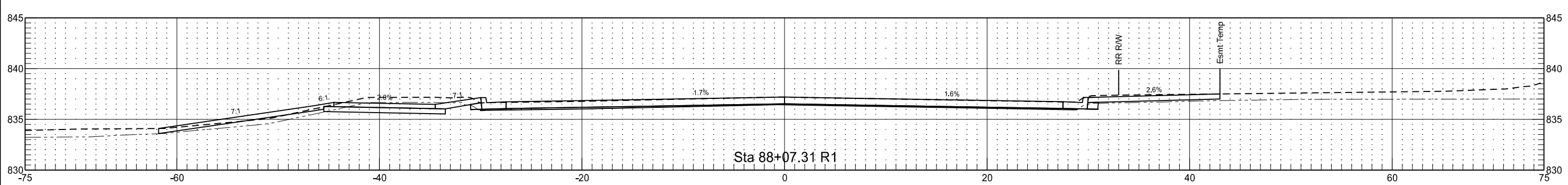

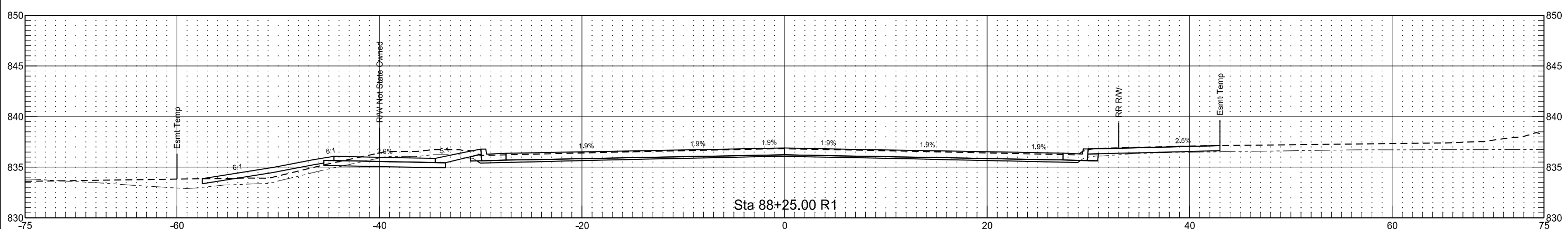

	STATE	PROJECT NO.	SECTION NO.	SHEET NO.
	ND	SU-6-986(121)125	200	3

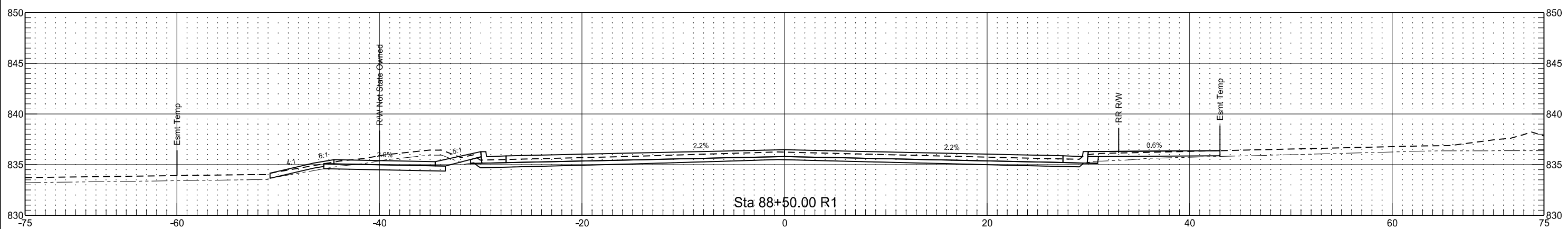
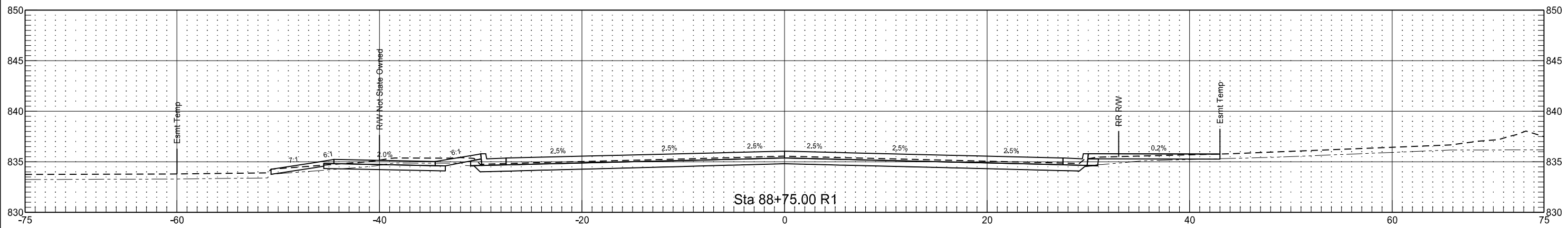
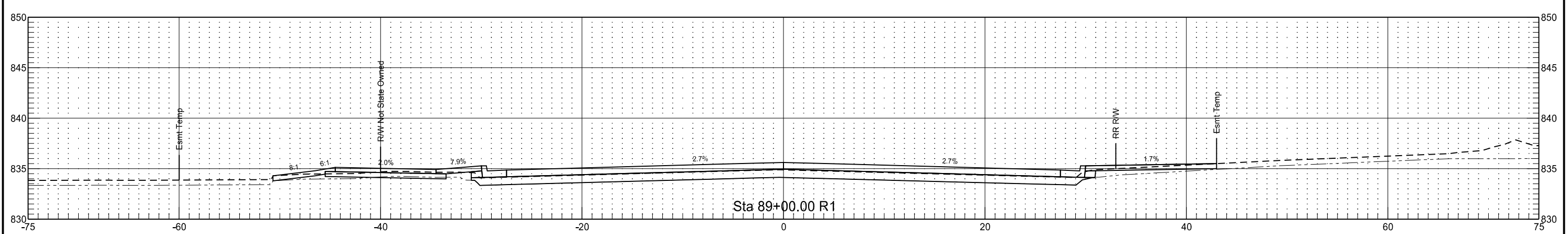
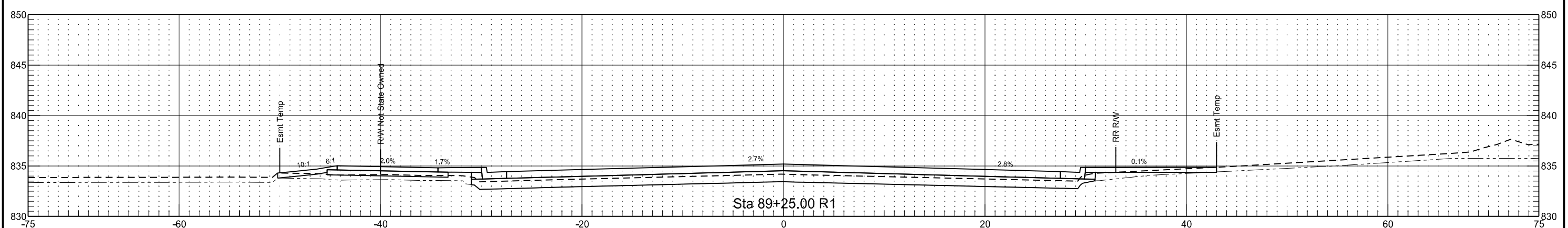
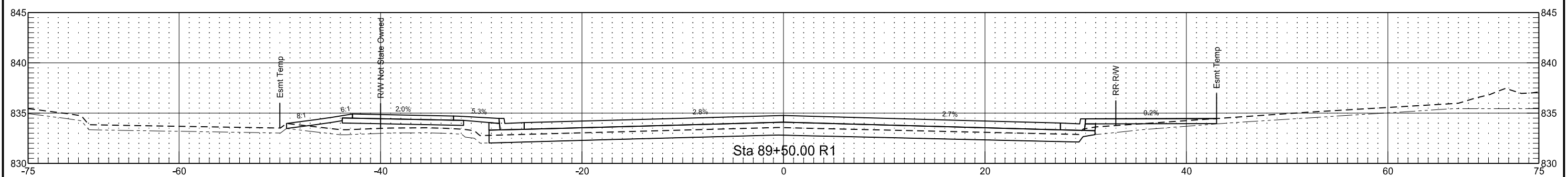
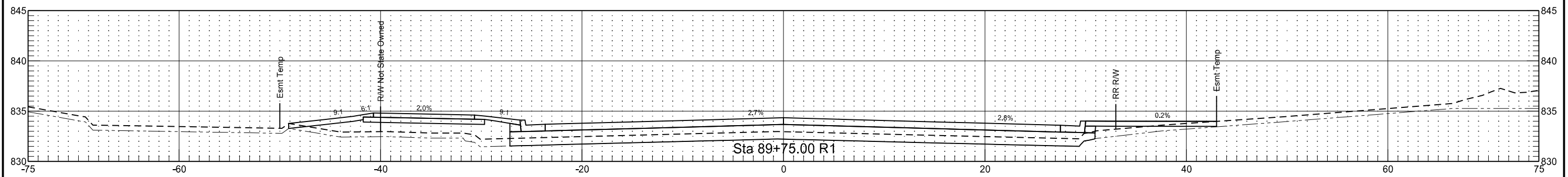
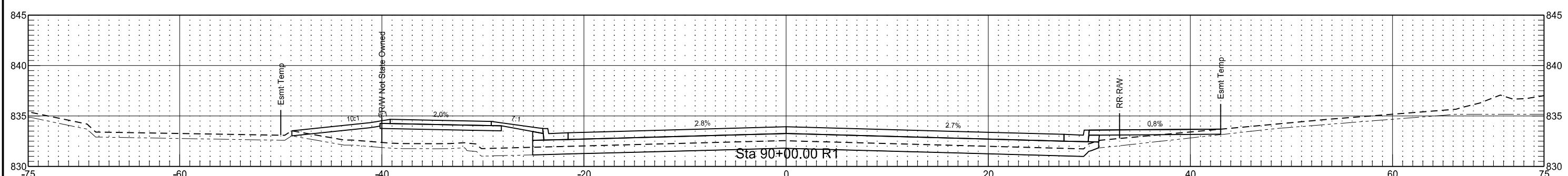
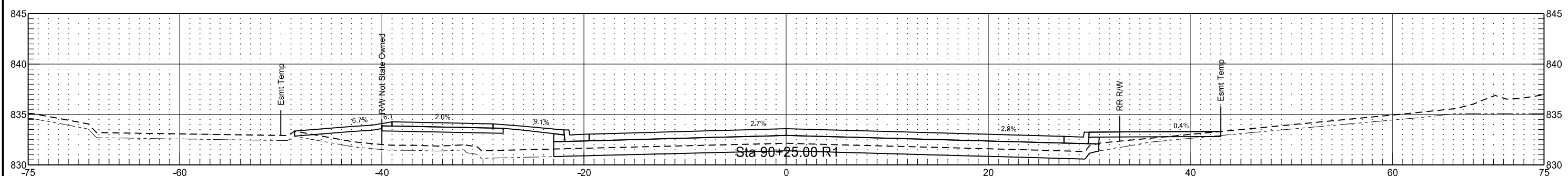
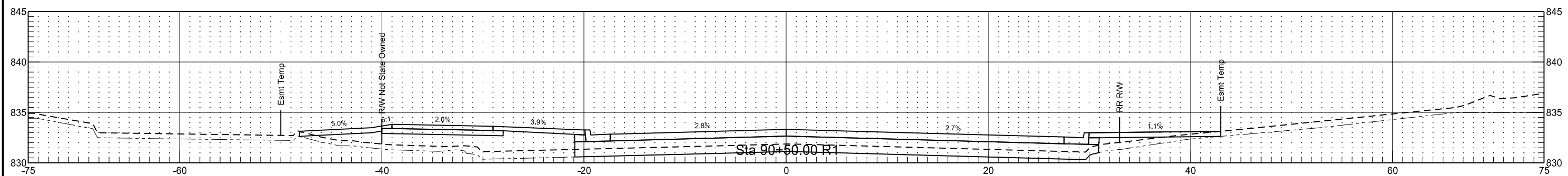
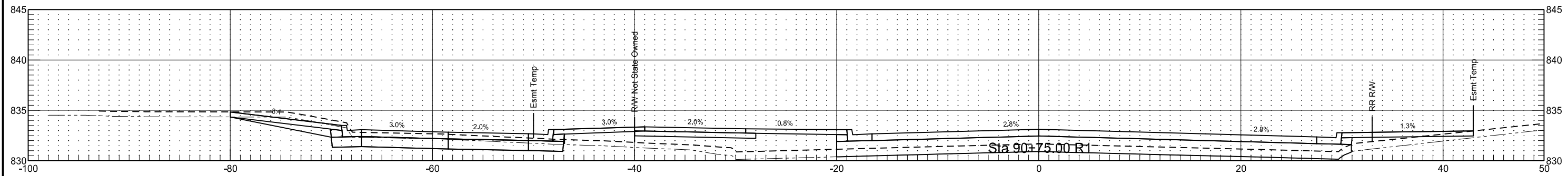

	STATE	PROJECT NO.	SECTION NO.	SHEET NO.
	ND	SU-6-986(121)125	200	4

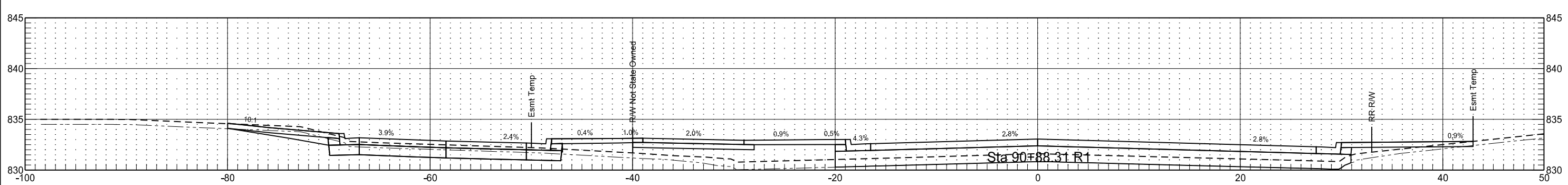
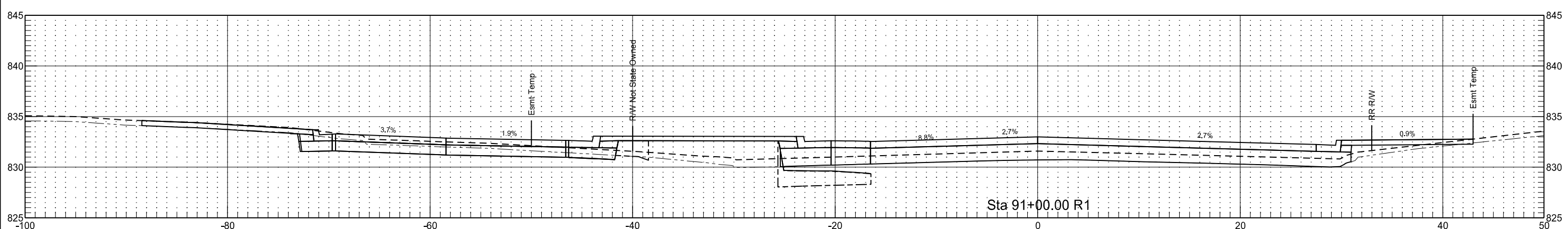
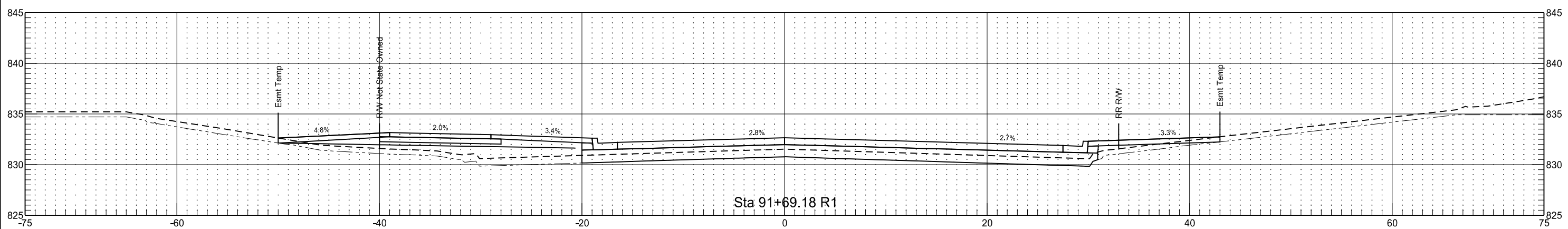
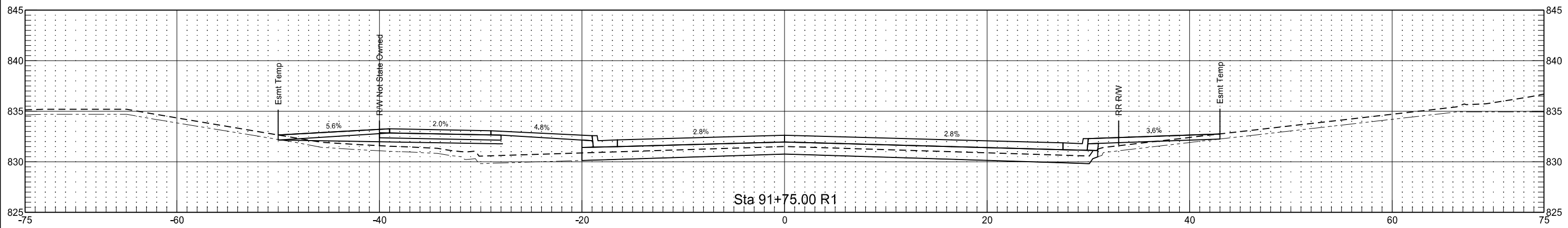

STATE  
ND

PROJECT NO.  
SU-6-986(121)125

SECTION NO.  
200

SHEET NO.  
5

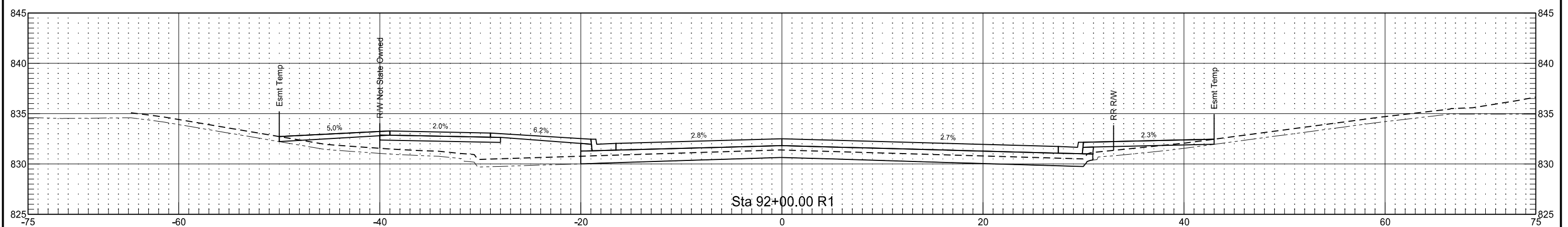
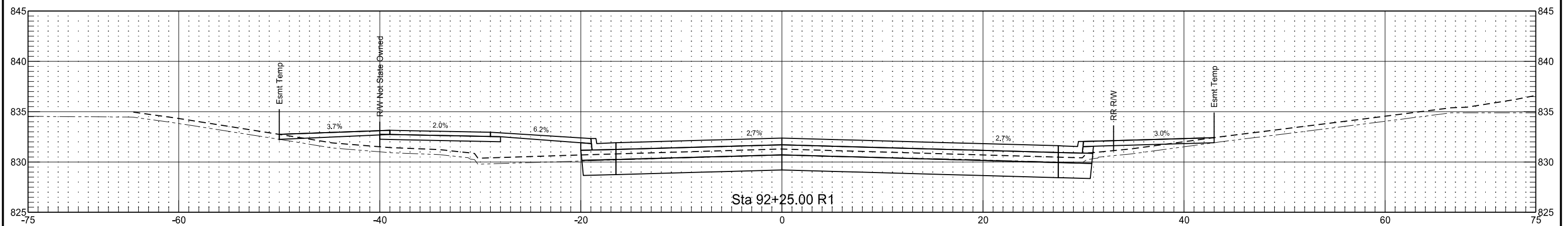
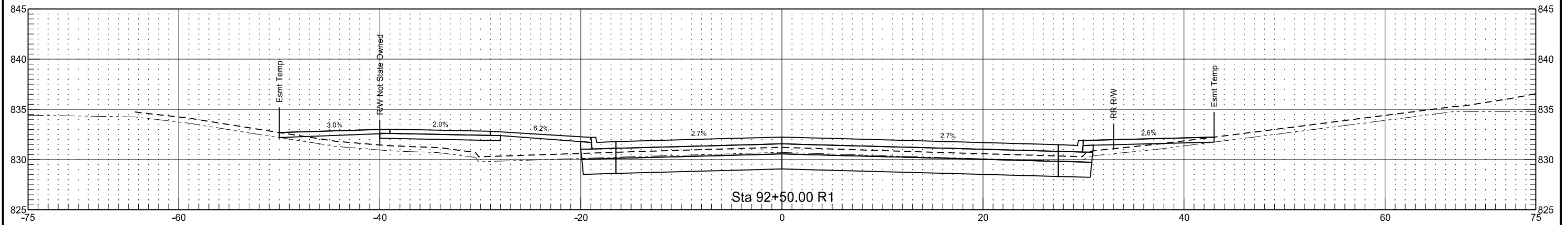

STATE  
ND

PROJECT NO.  
SU-6-986(121)125

SECTION NO.  
200

SHEET NO.  
6

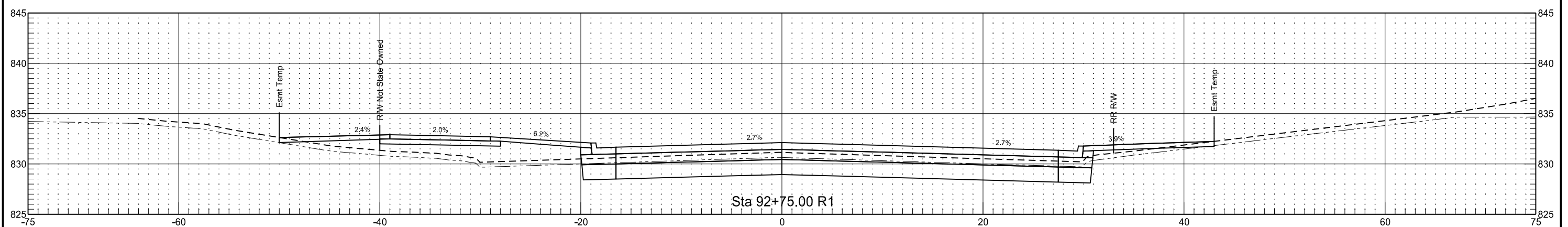
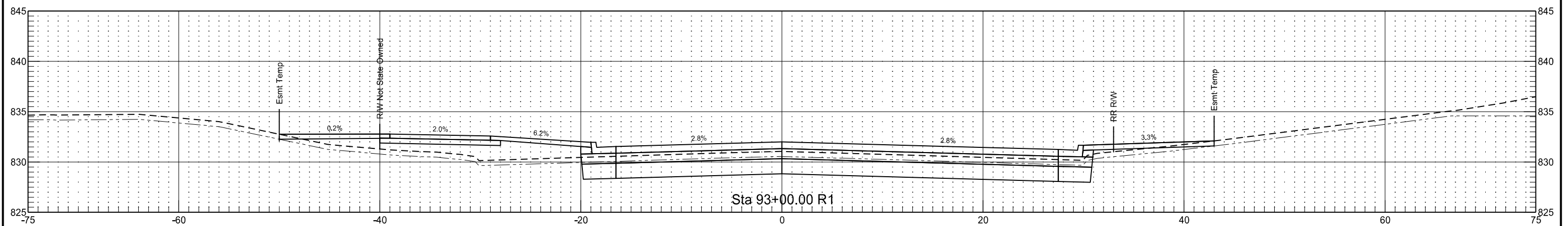
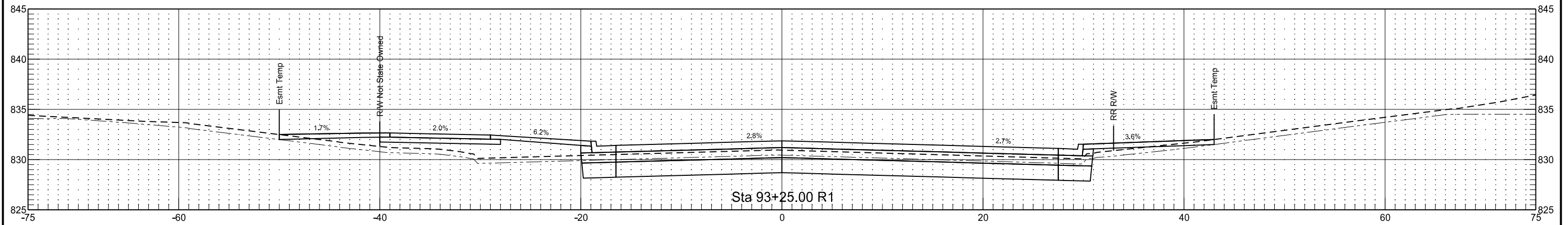

	STATE	PROJECT NO.	SECTION NO.	SHEET NO.
	ND	SU-6-986(121)125	200	7

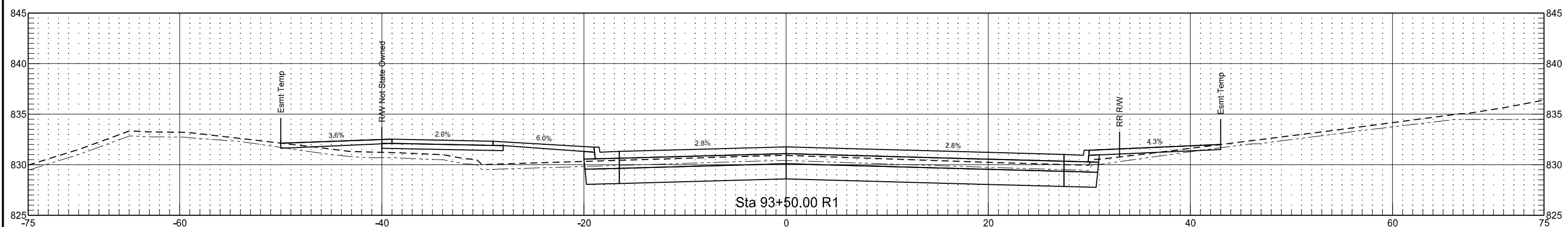
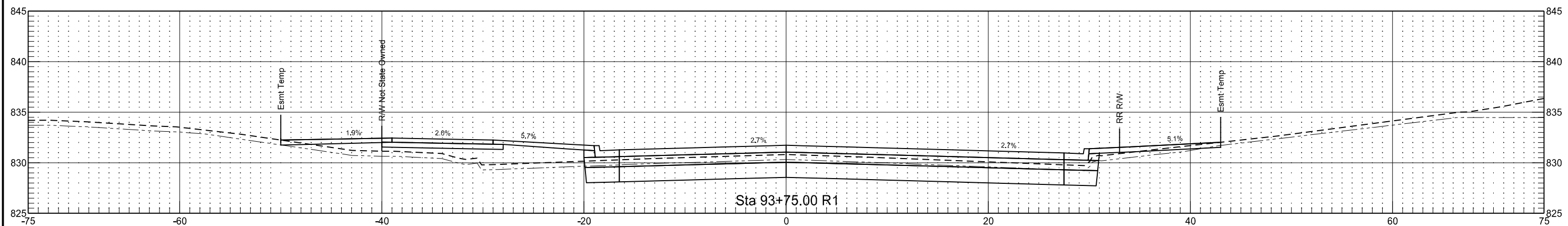
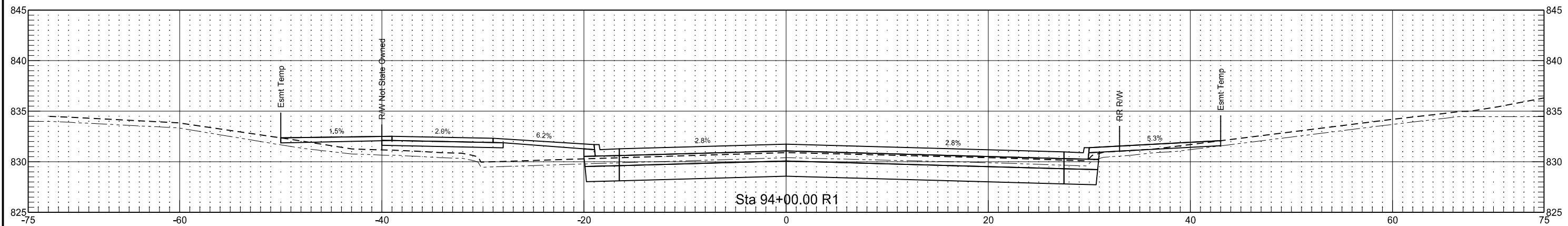

STATE  
ND

PROJECT NO.  
SU-6-986(121)125

SECTION NO.  
200

SHEET NO.  
8

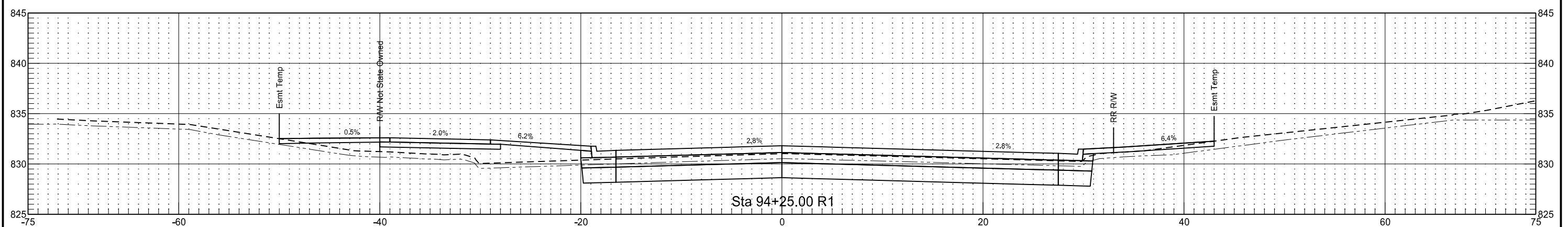
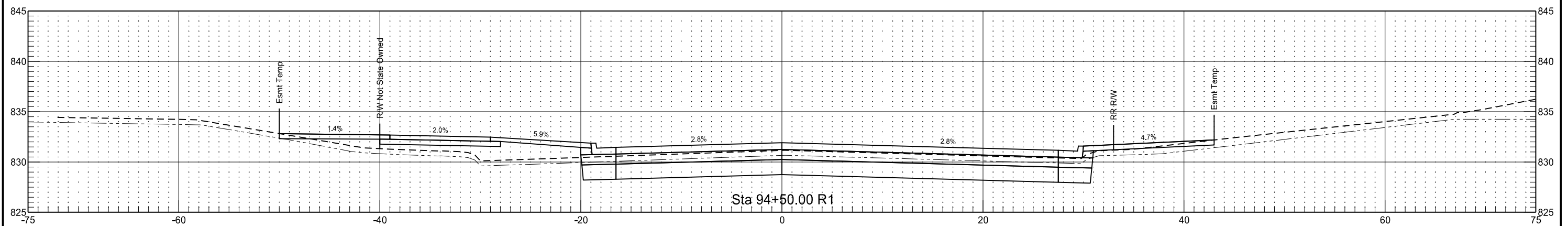
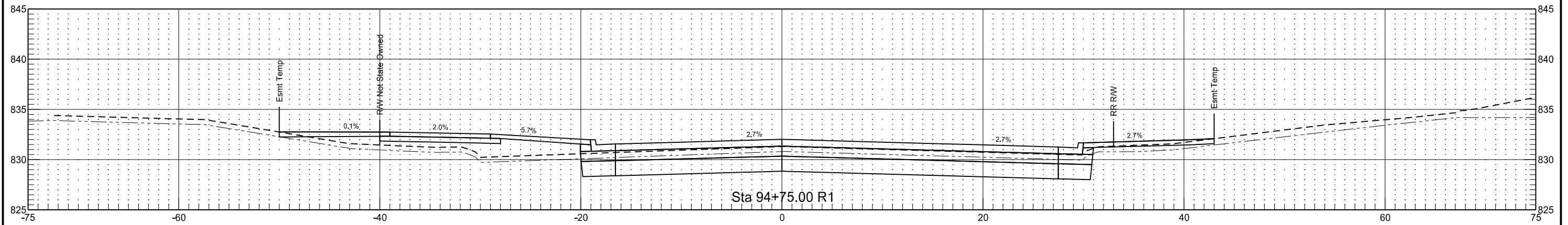



	STATE	PROJECT NO.	SECTION NO.	SHEET NO.
	ND	SU-6-986(121)125	200	9

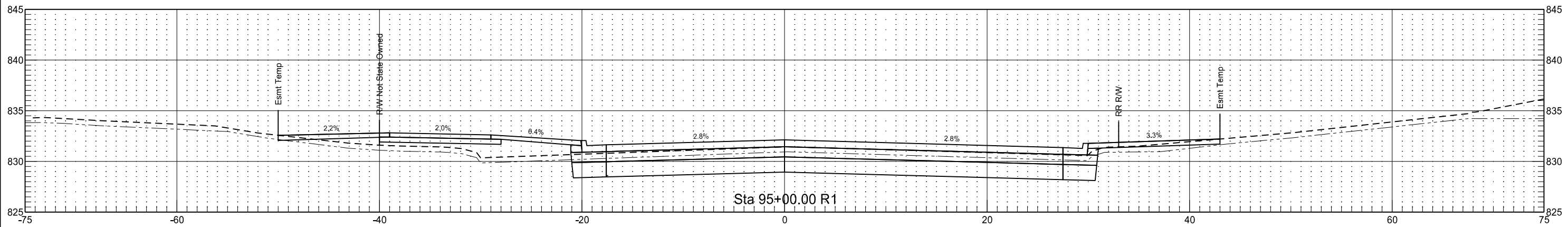
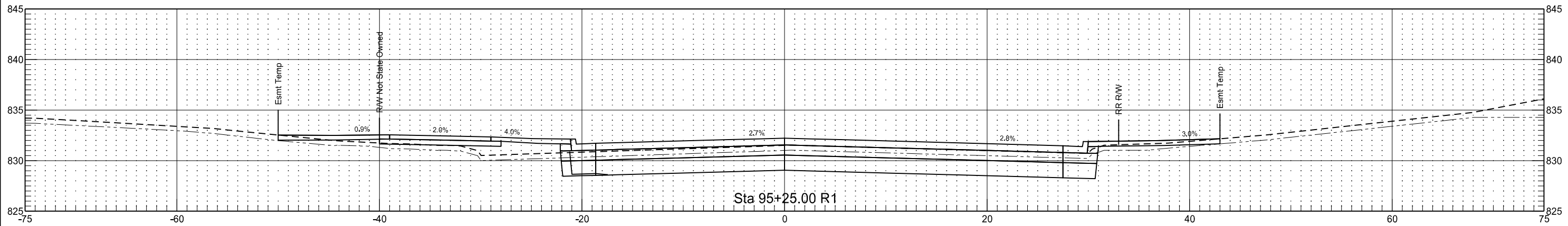
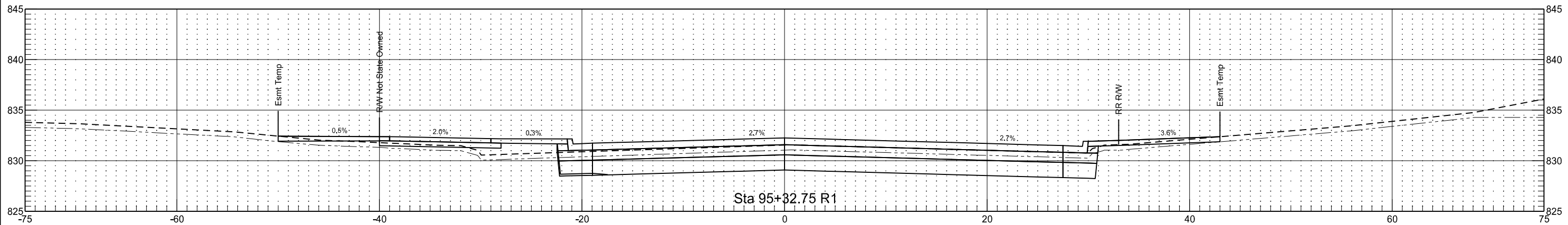

	STATE	PROJECT NO.	SECTION NO.	SHEET NO.
	ND	SU-6-986(121)125	200	10

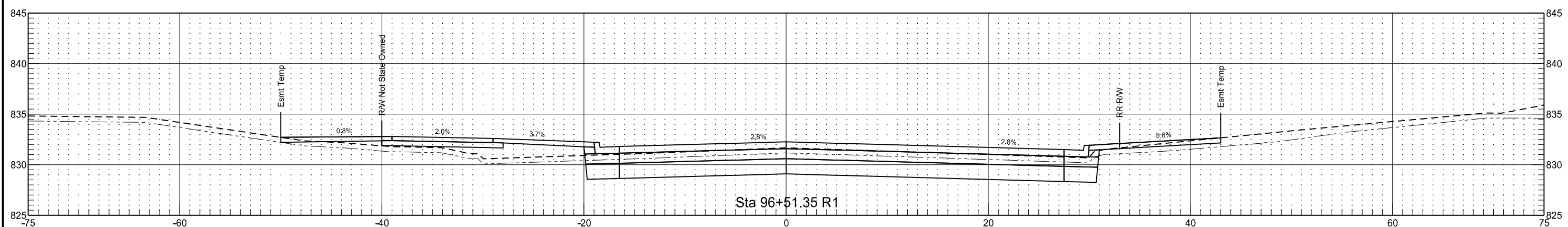
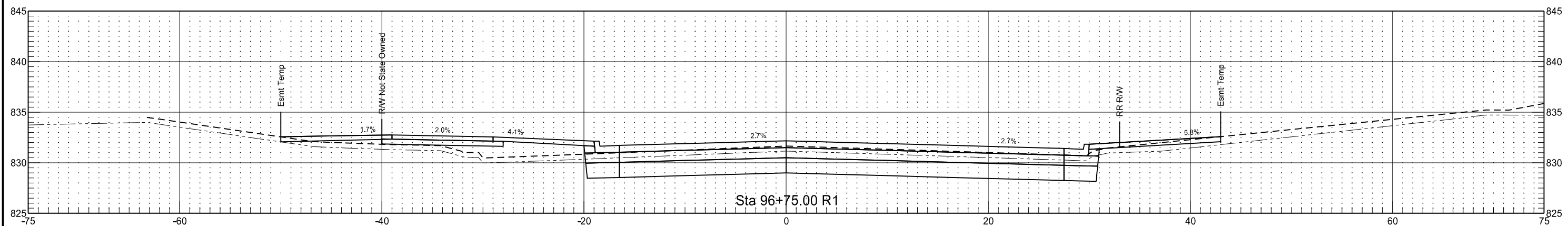
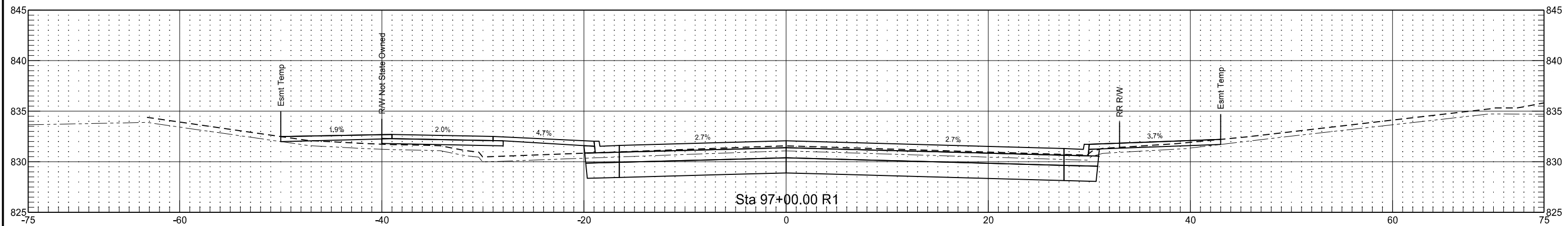

STATE  
ND

PROJECT NO.  
SU-6-986(121)125

SECTION NO.  
200

SHEET NO.  
11

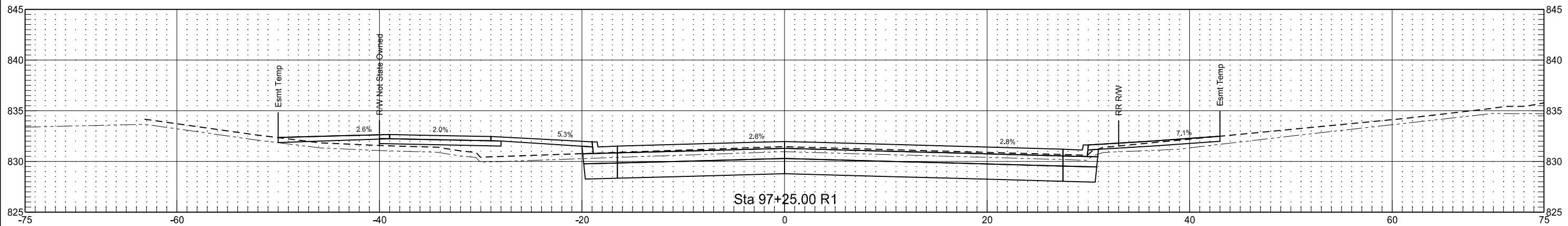
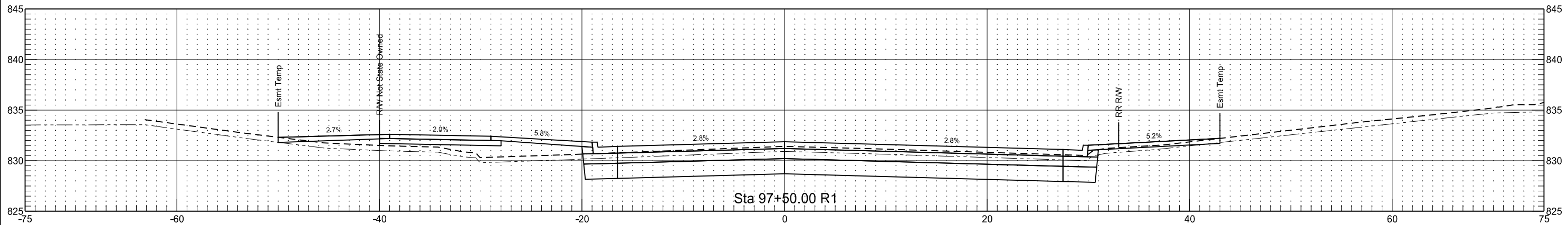
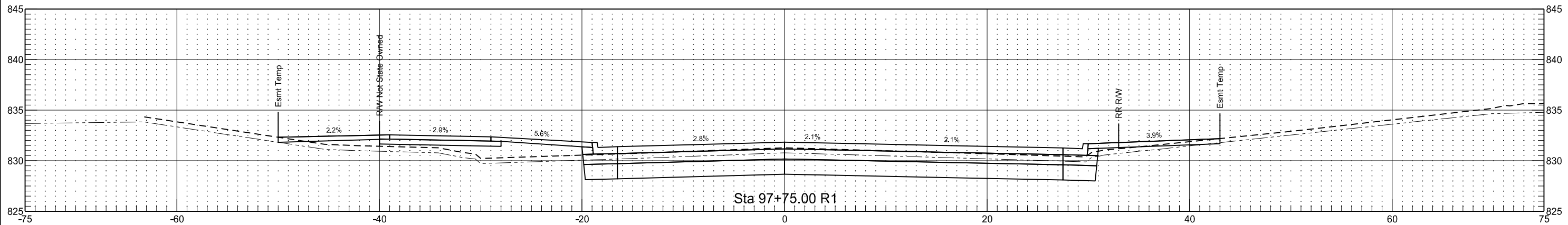

STATE  
ND

PROJECT NO.  
SU-6-986(121)125

SECTION NO.  
200

SHEET NO.  
12

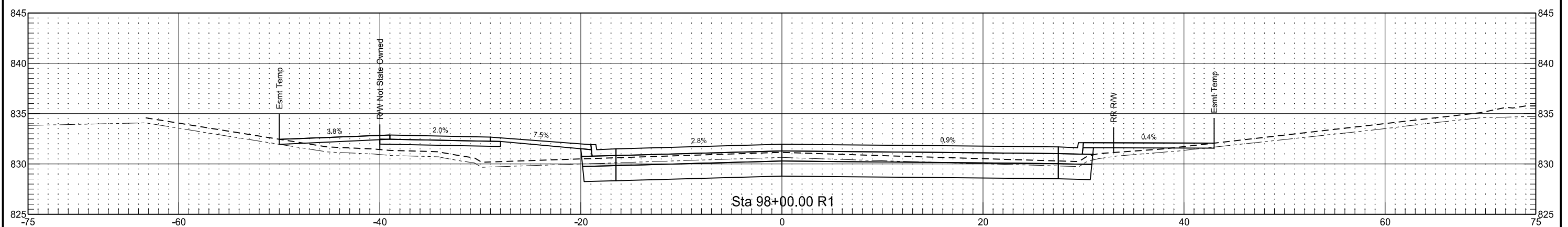
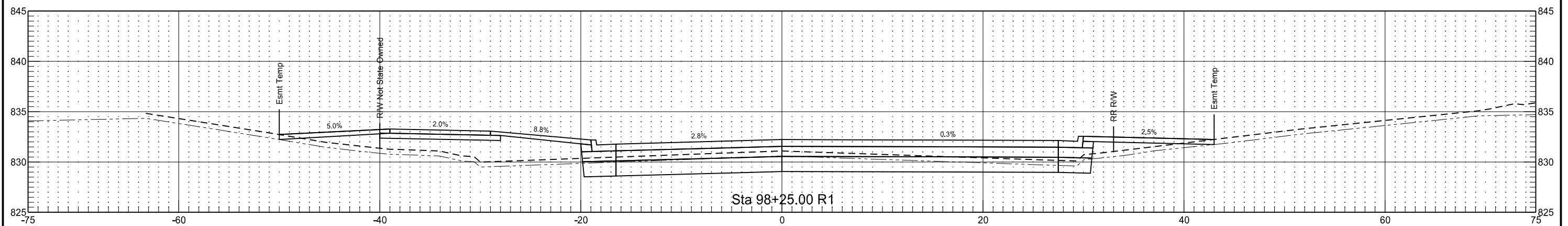
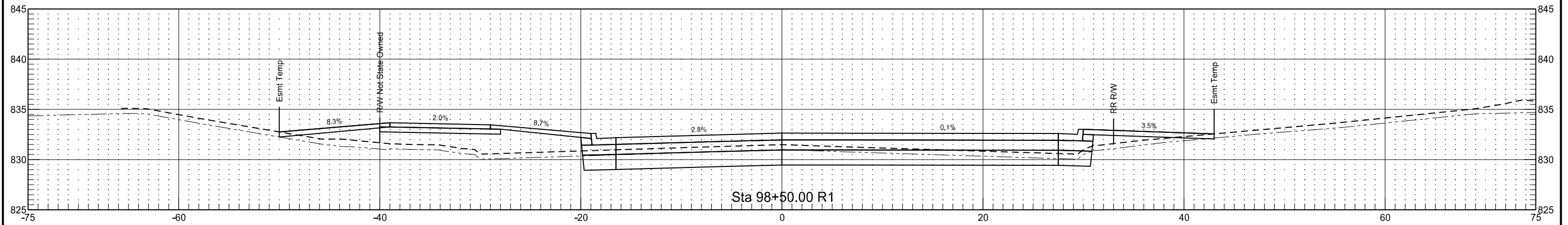

STATE  
ND

PROJECT NO.  
SU-6-986(121)125

SECTION NO.  
200

SHEET NO.  
13

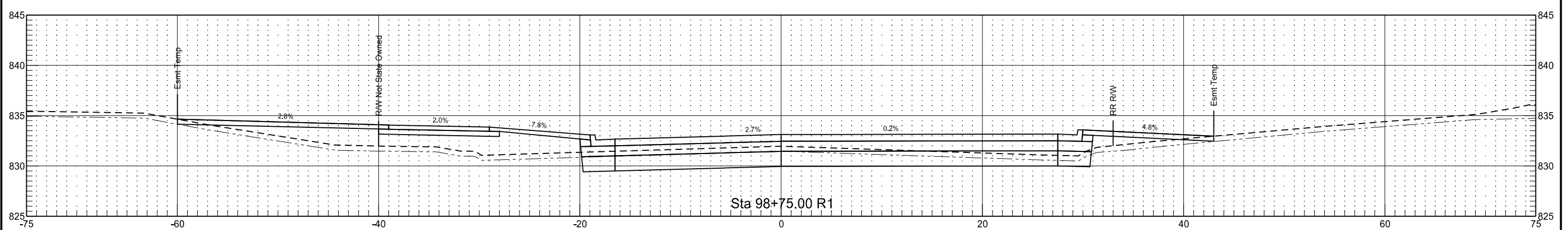
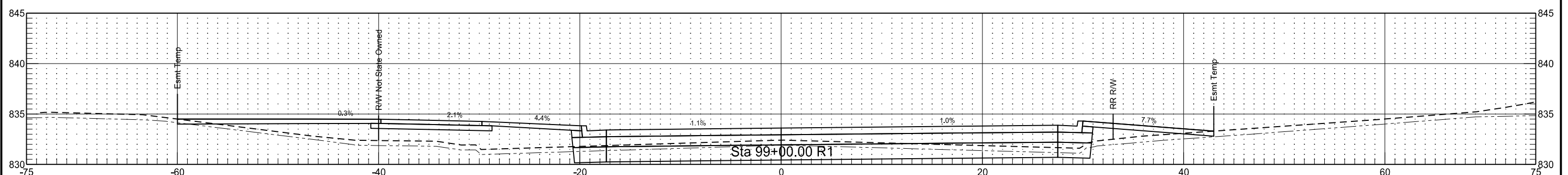
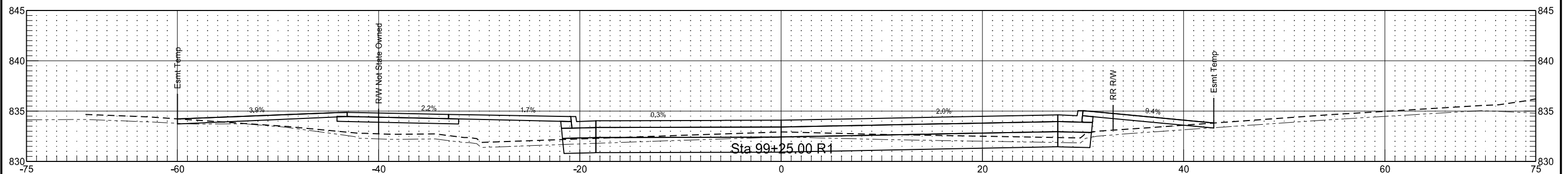
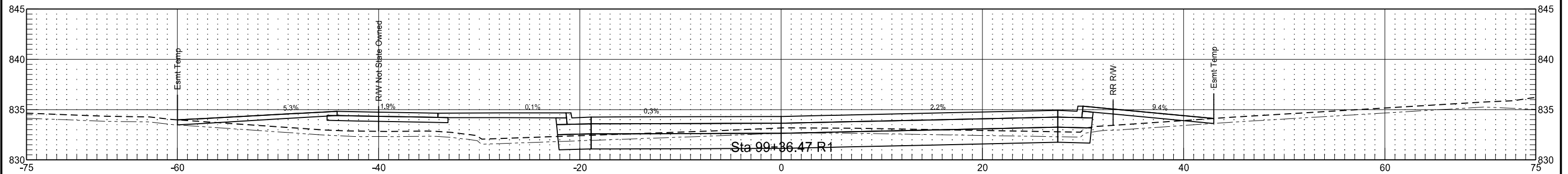

	STATE	PROJECT NO.	SECTION NO.	SHEET NO.
	ND	SU-6-986(121)125	200	14

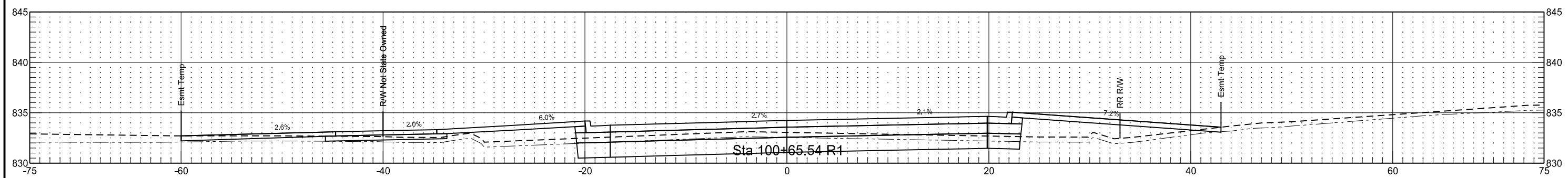
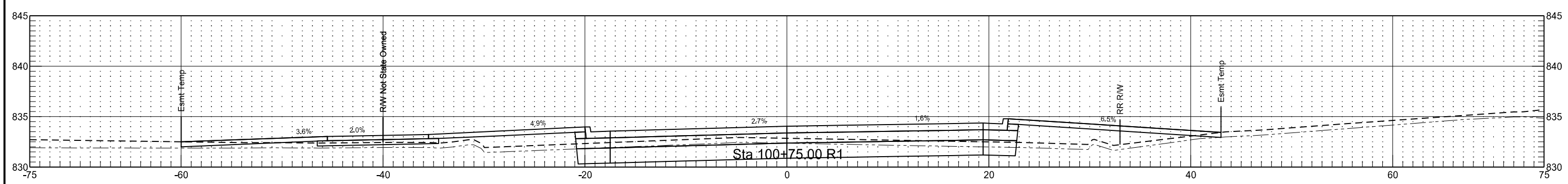
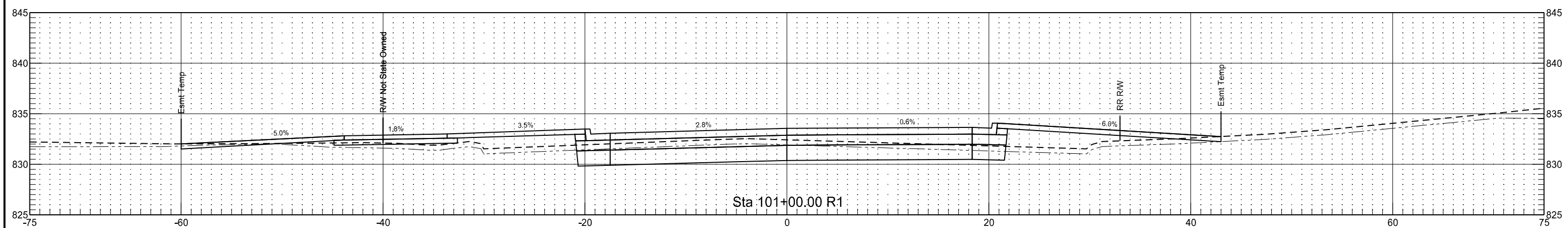
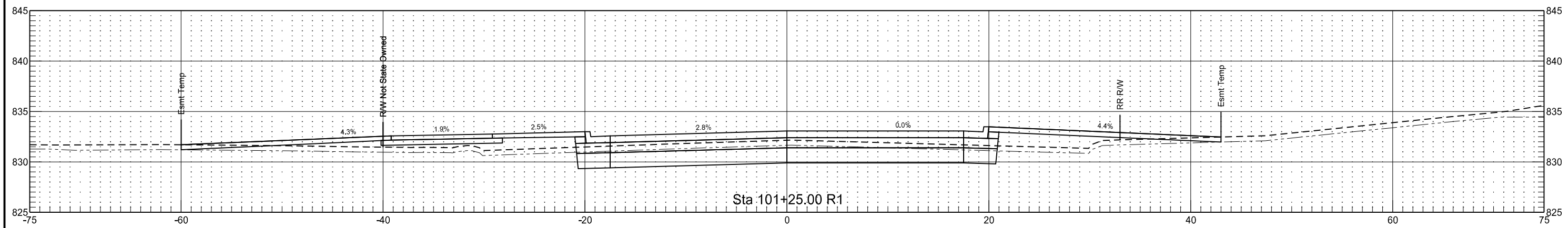

	STATE	PROJECT NO.	SECTION NO.	SHEET NO.
	ND	SU-6-986(121)125	200	15

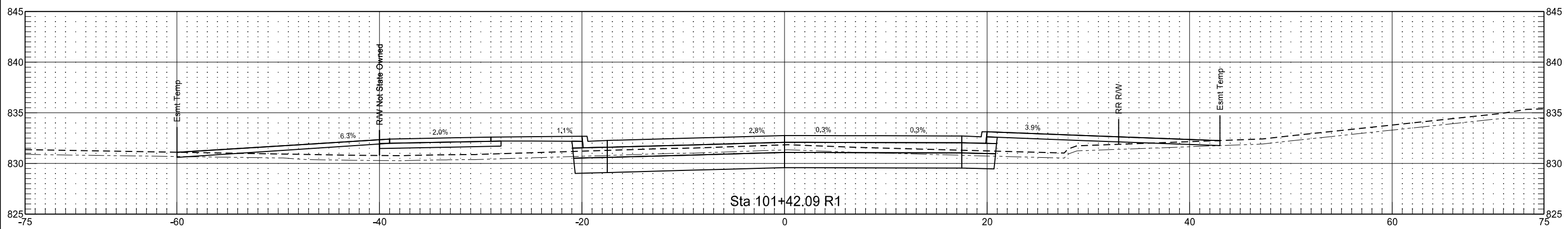
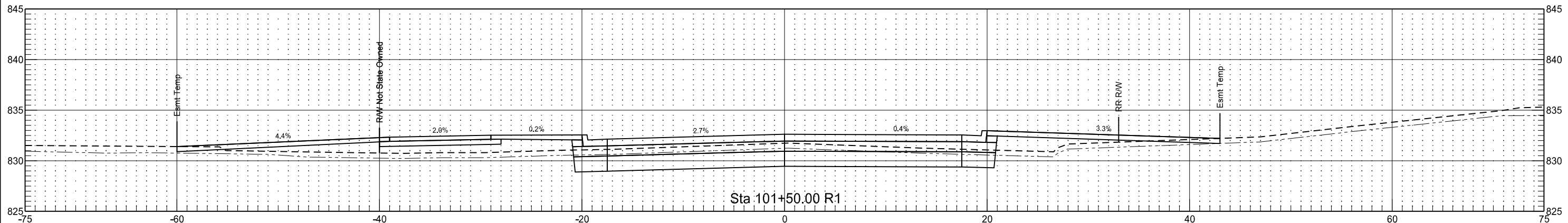
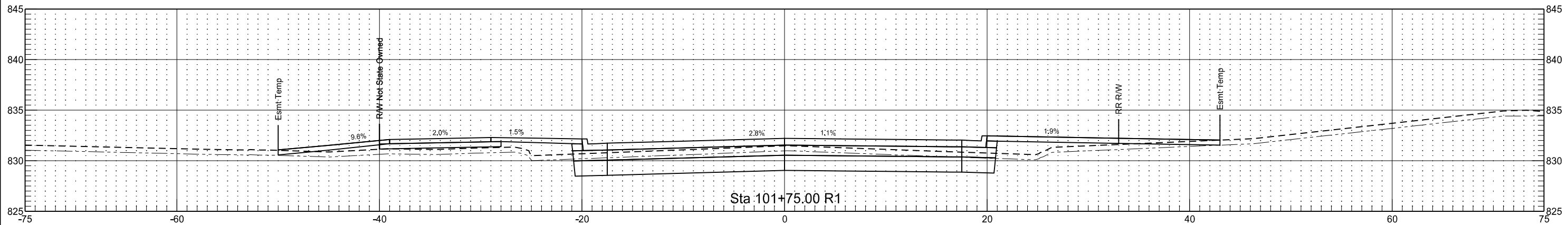

STATE  
ND

PROJECT NO.  
SU-6-986(121)125

SECTION NO.  
200

SHEET NO.  
16

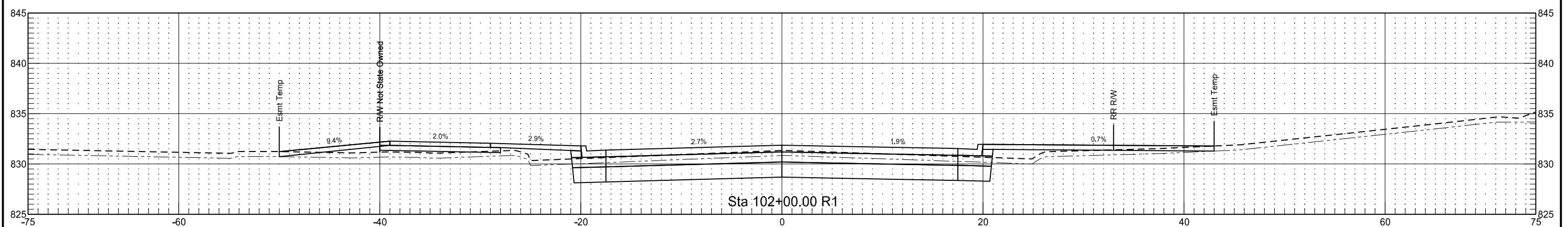
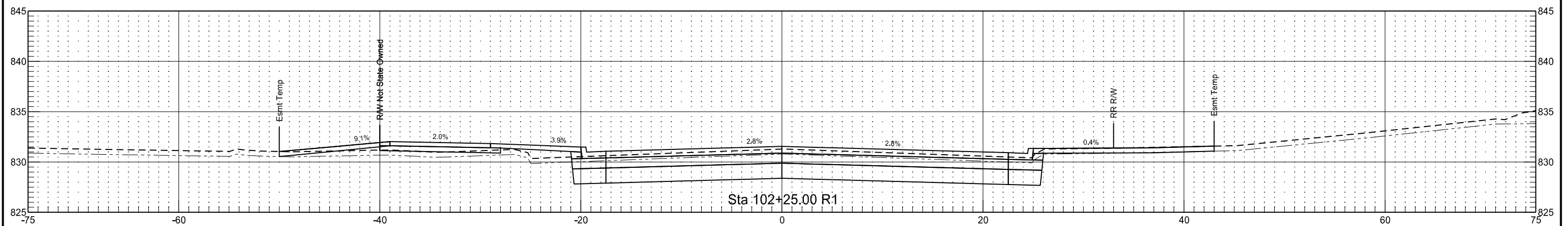
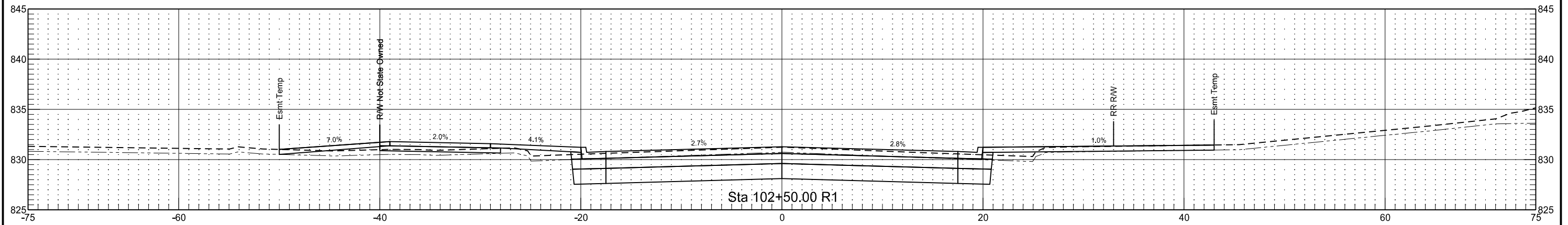



	STATE	PROJECT NO.	SECTION NO.	SHEET NO.
	ND	SU-6-986(121)125	200	17

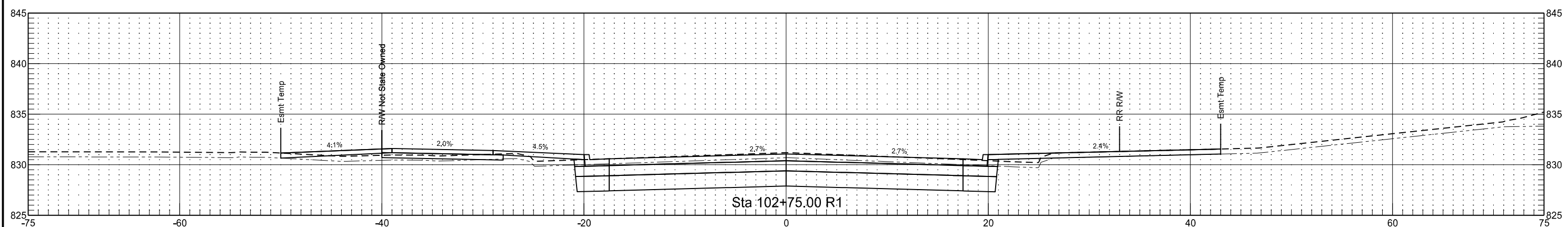
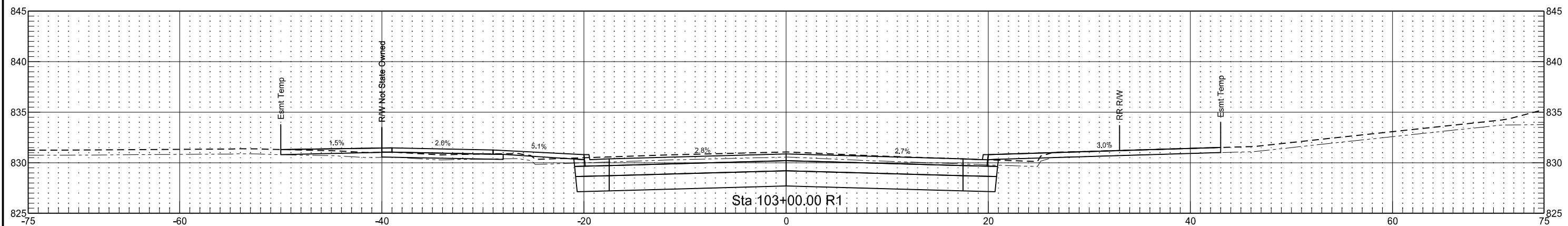
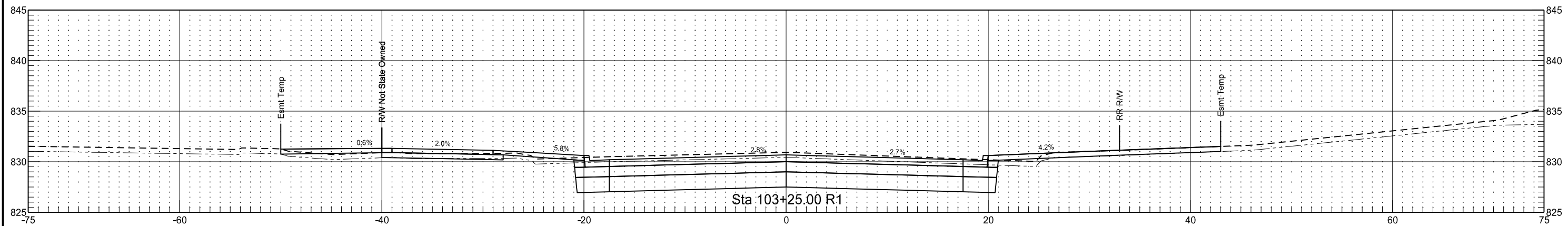

	STATE	PROJECT NO.	SECTION NO.	SHEET NO.
	ND	SU-6-986(121)125	200	18

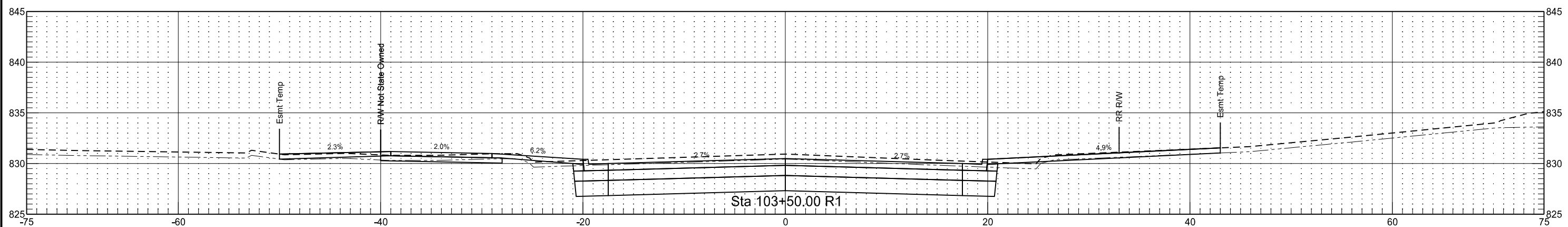
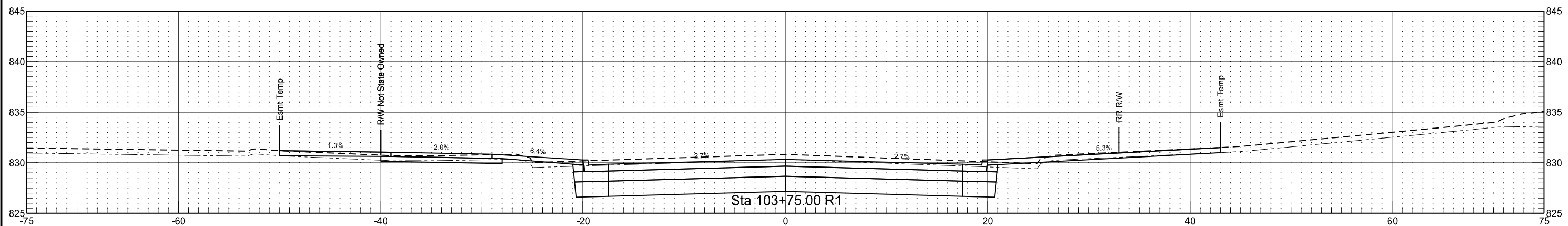
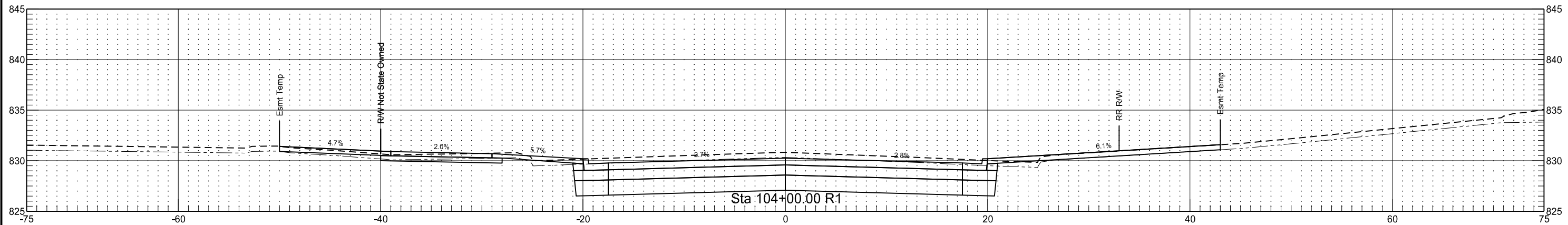

	STATE	PROJECT NO.	SECTION NO.	SHEET NO.
	ND	SU-6-986(121)125	200	19

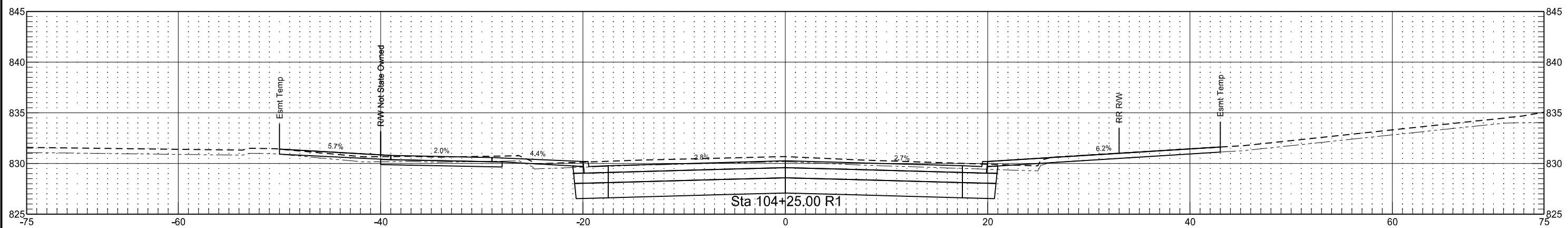
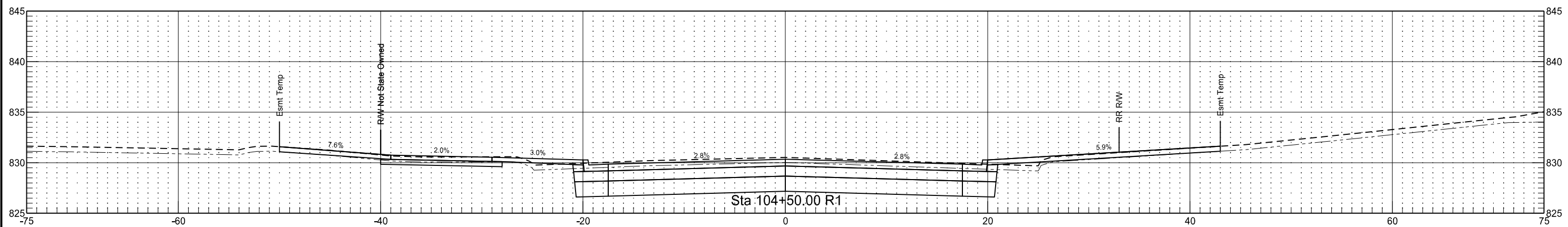
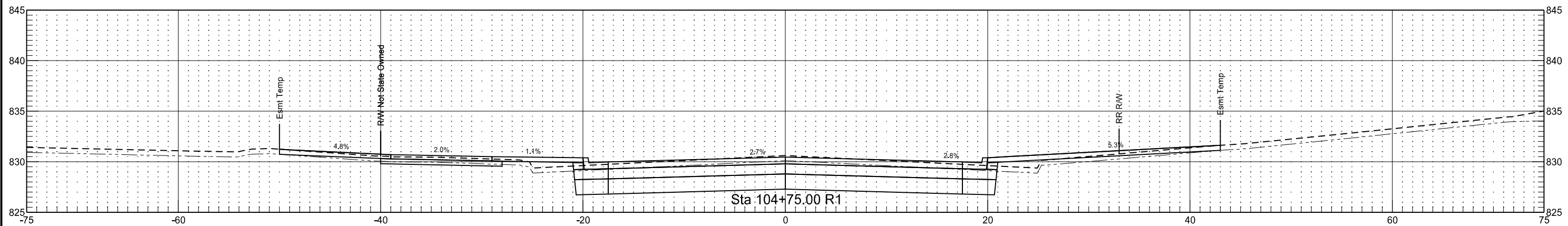

	STATE	PROJECT NO.	SECTION NO.	SHEET NO.
	ND	SU-6-986(121)125	200	20

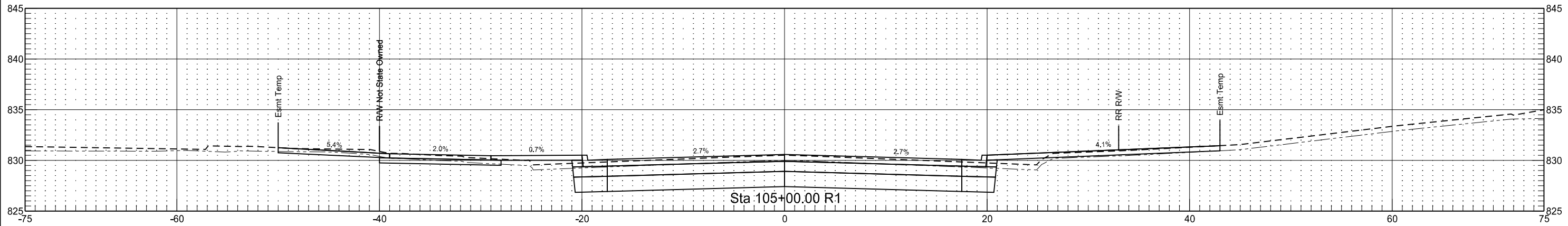
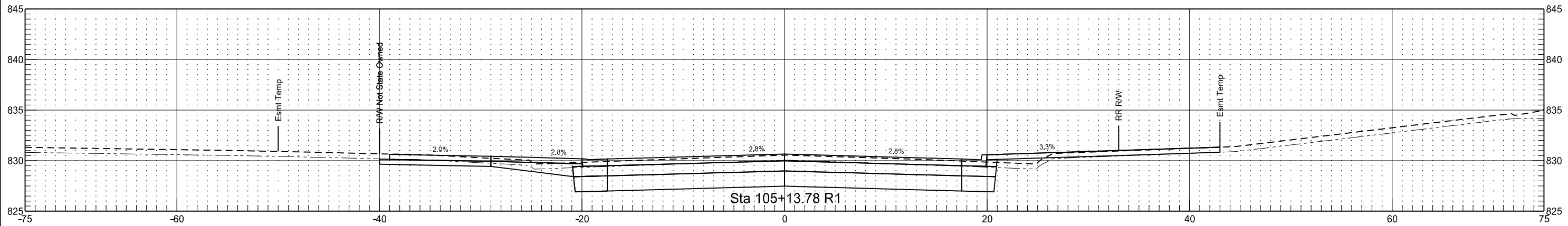
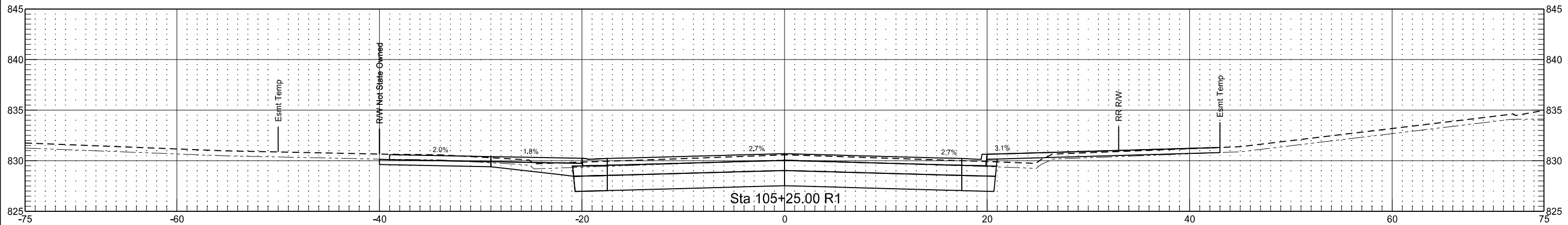

	STATE	PROJECT NO.	SECTION NO.	SHEET NO.
	ND	SU-6-986(121)125	200	21

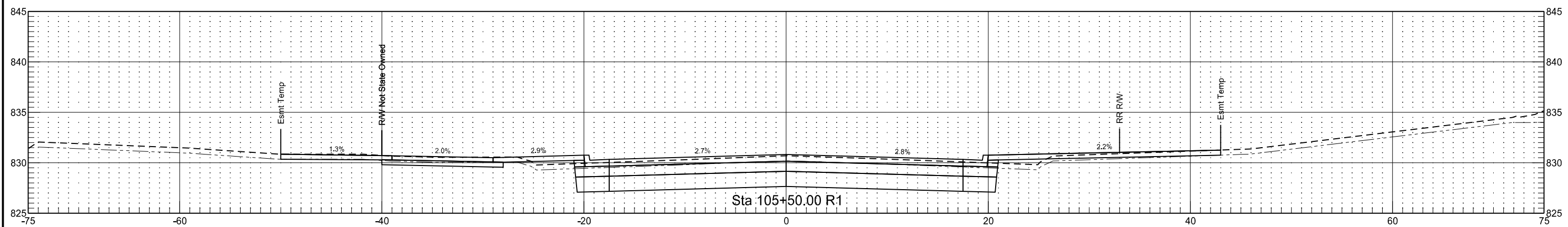
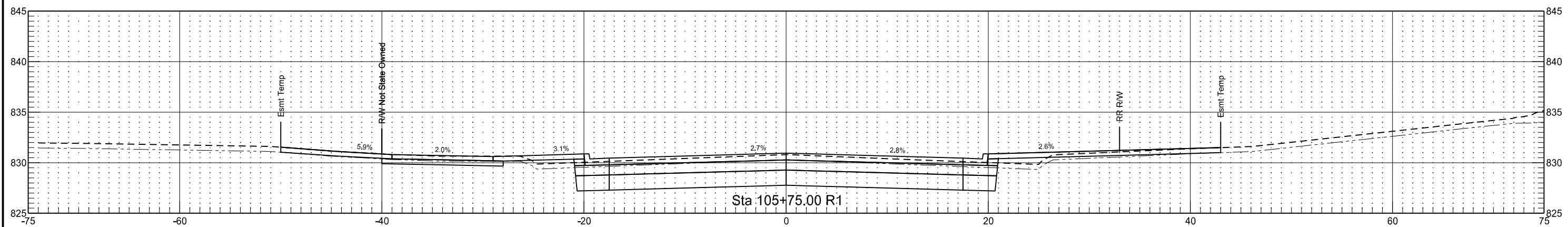
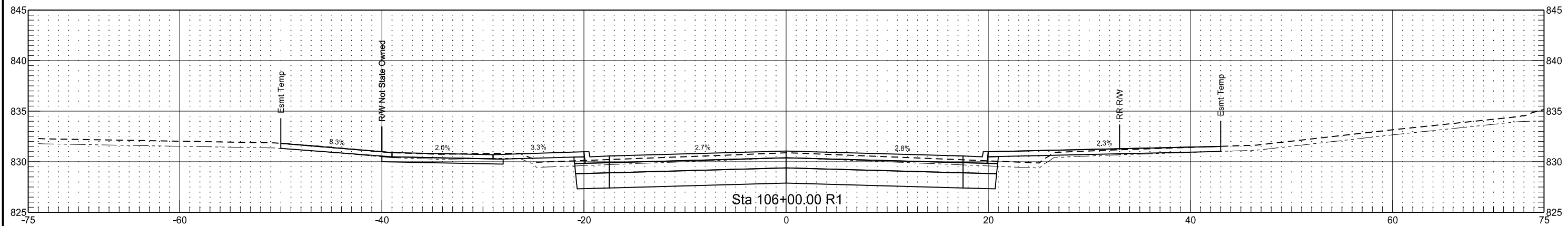

	STATE	PROJECT NO.	SECTION NO.	SHEET NO.
	ND	SU-6-986(121)125	200	22

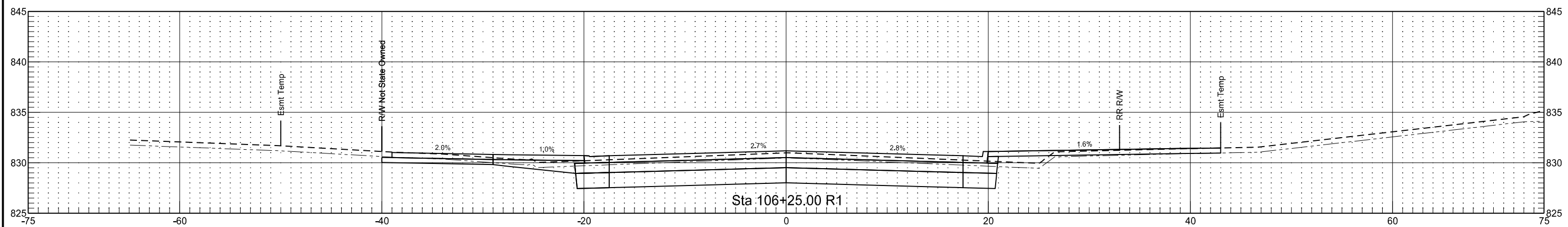
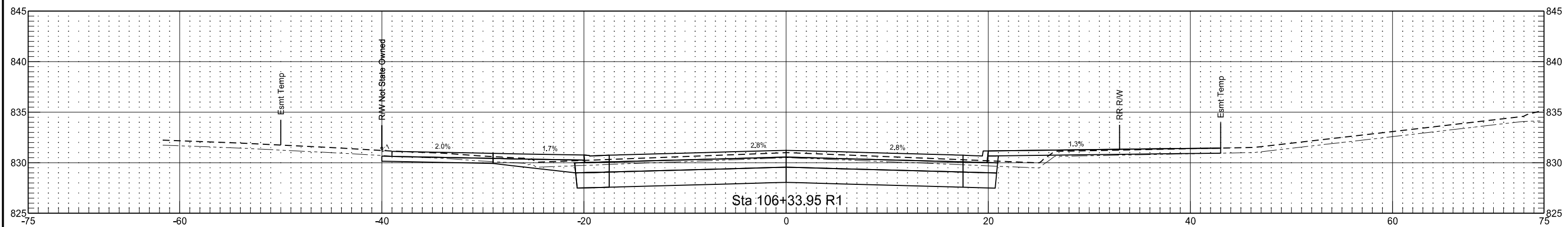
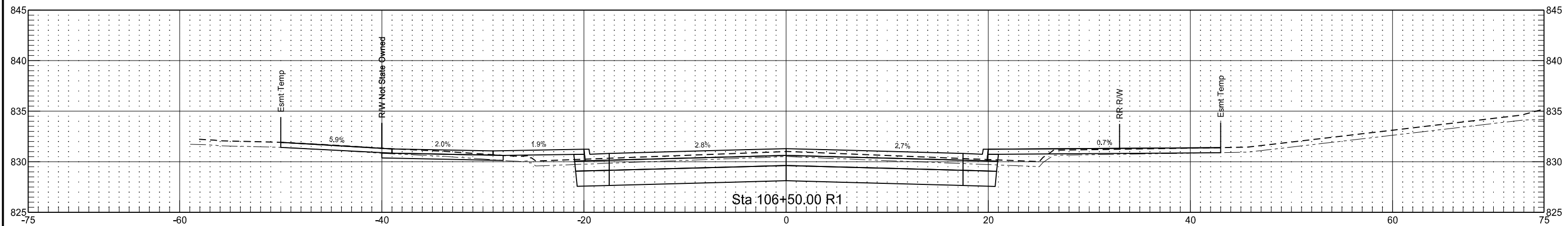

	STATE	PROJECT NO.	SECTION NO.	SHEET NO.
	ND	SU-6-986(121)125	200	23

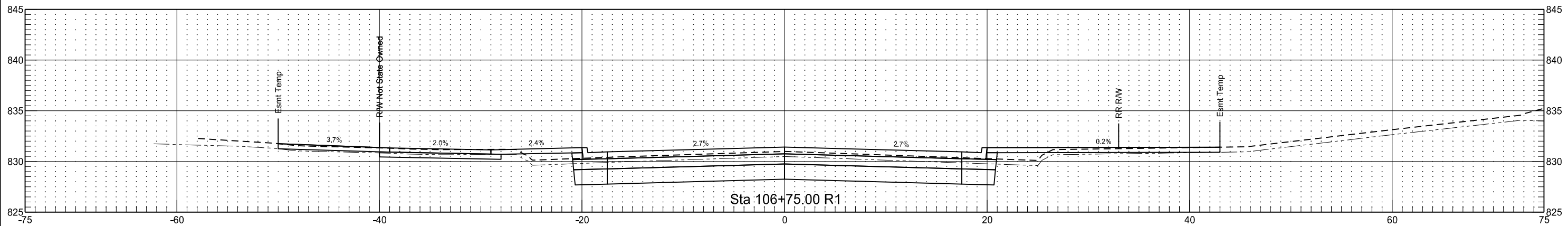
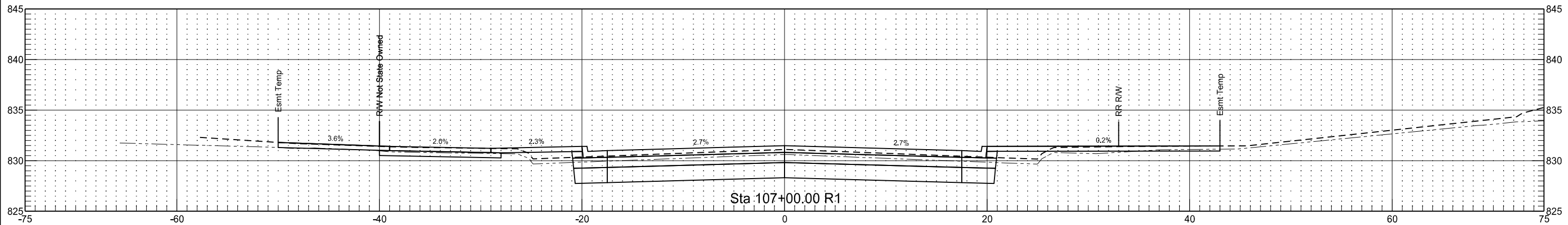
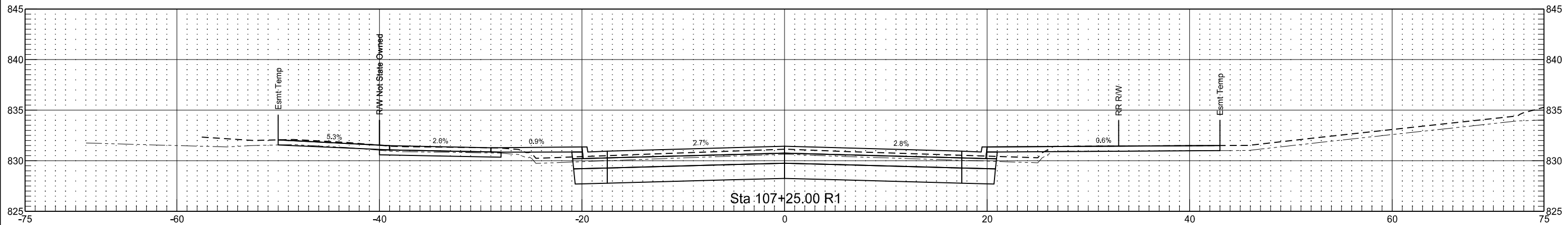

	STATE	PROJECT NO.	SECTION NO.	SHEET NO.
	ND	SU-6-986(121)125	200	24

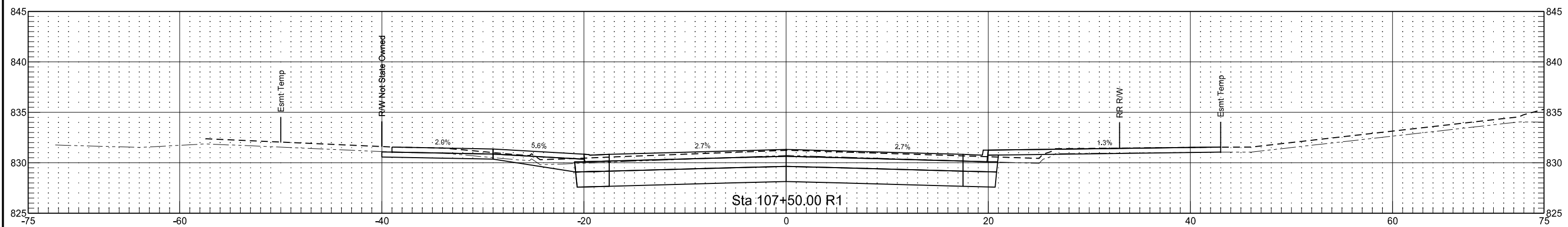
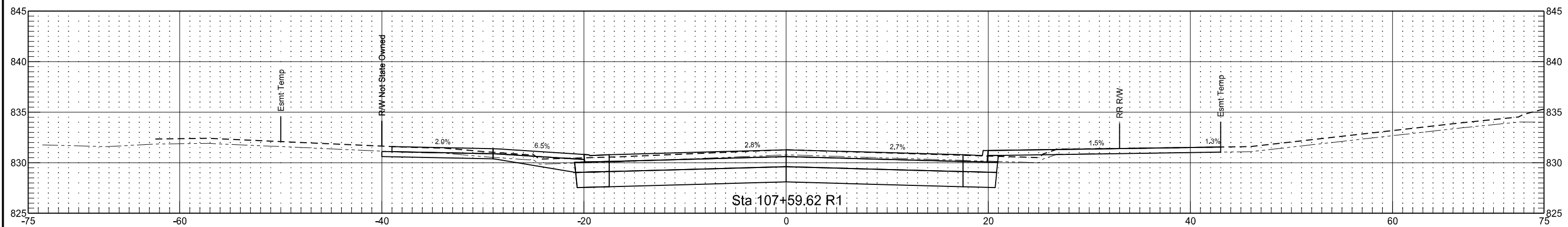
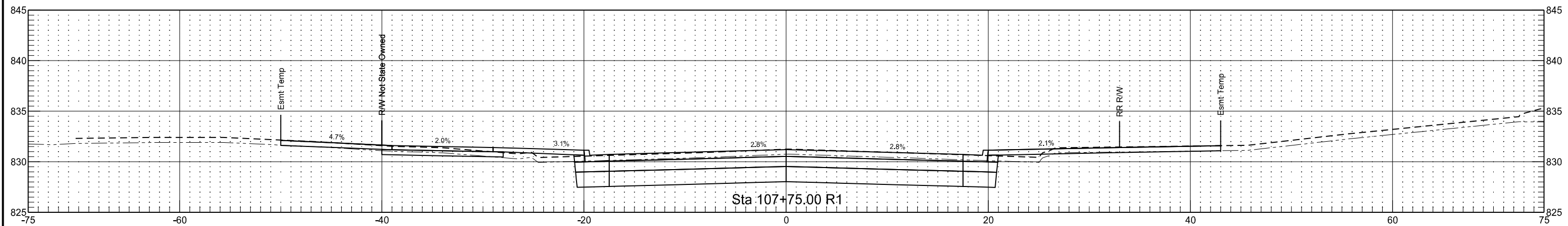



	STATE	PROJECT NO.	SECTION NO.	SHEET NO.
	ND	SU-6-986(121)125	200	25

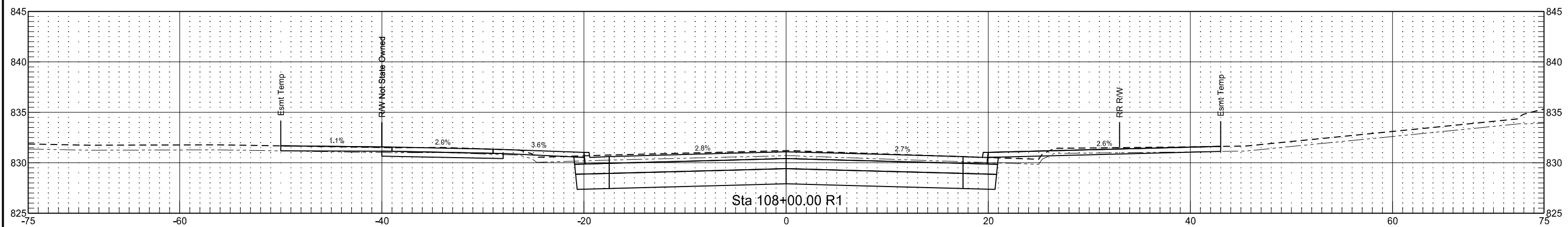
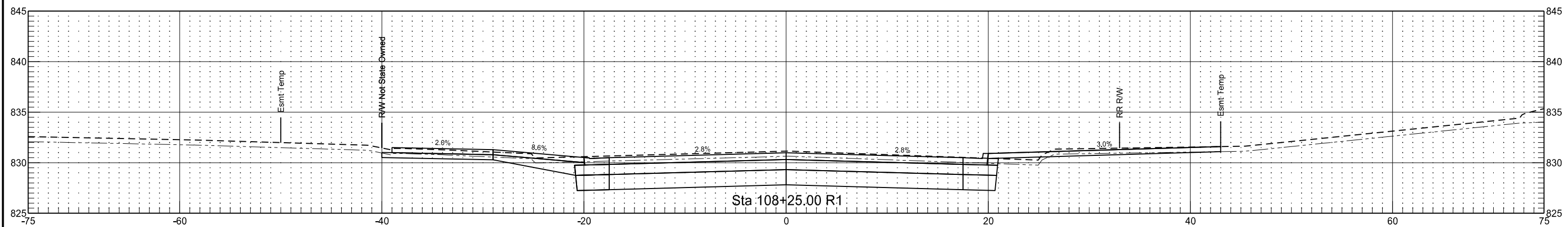
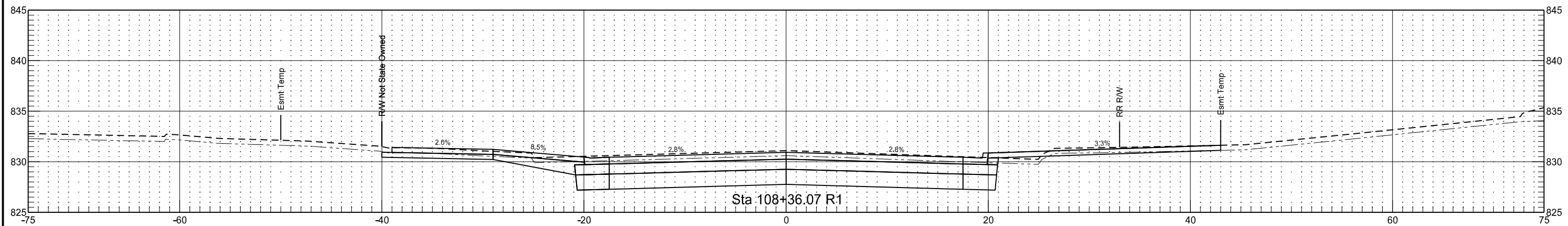

	STATE	PROJECT NO.	SECTION NO.	SHEET NO.
	ND	SU-6-986(121)125	200	26

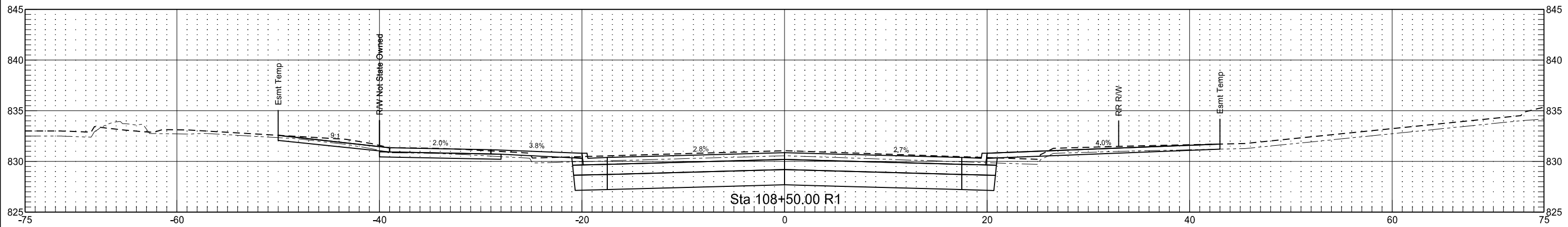
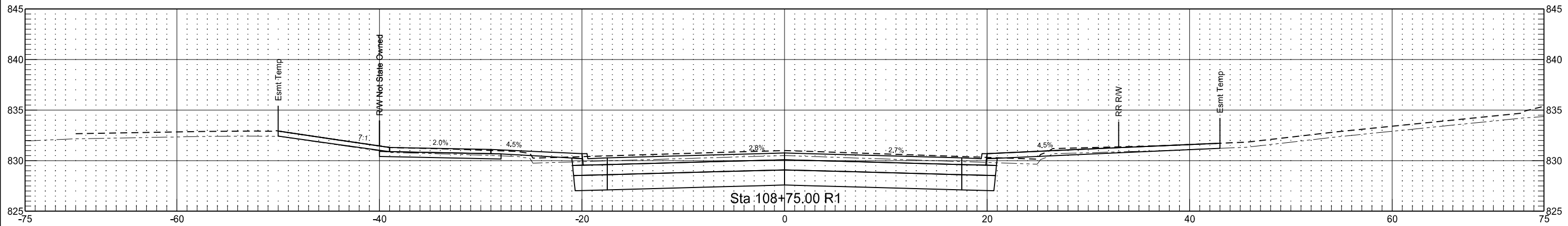
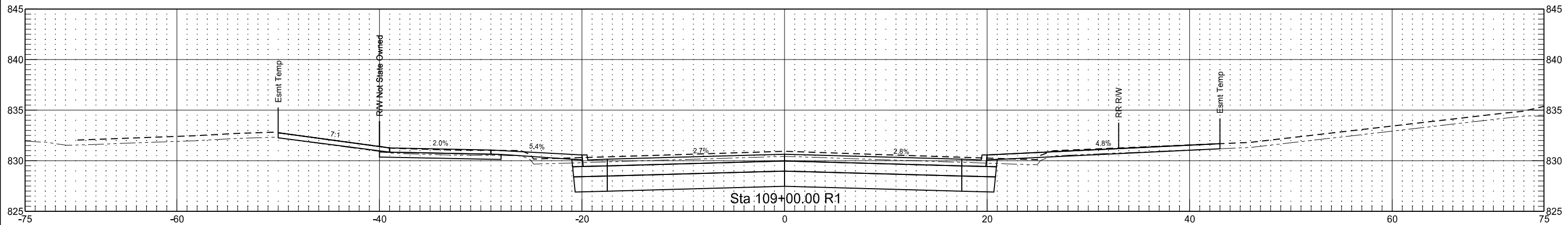

	STATE	PROJECT NO.	SECTION NO.	SHEET NO.
	ND	SU-6-986(121)125	200	27

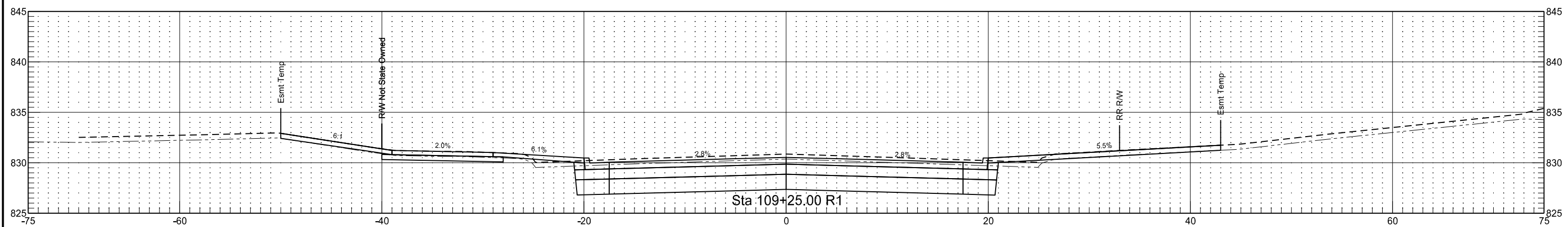
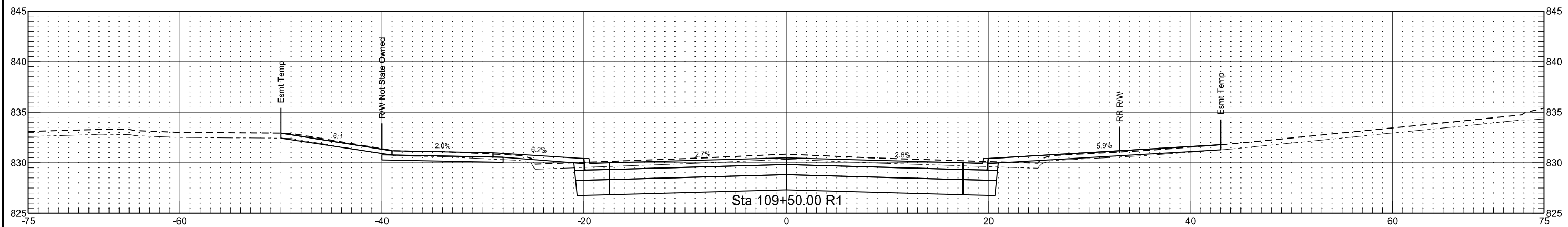
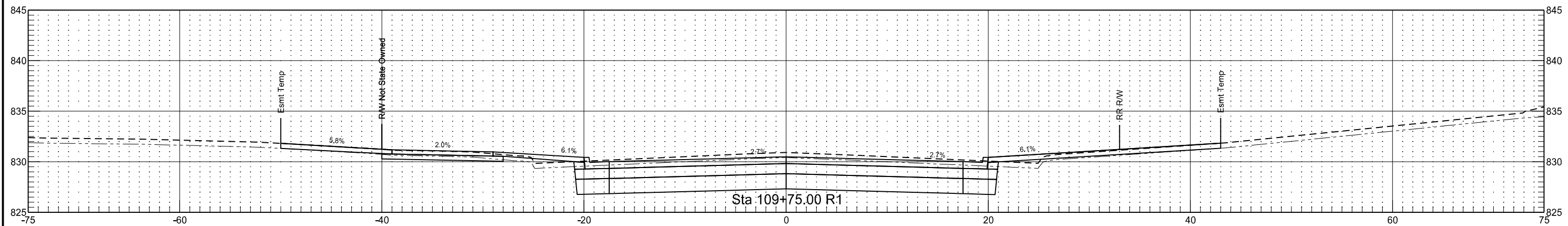

	STATE	PROJECT NO.	SECTION NO.	SHEET NO.
	ND	SU-6-986(121)125	200	28

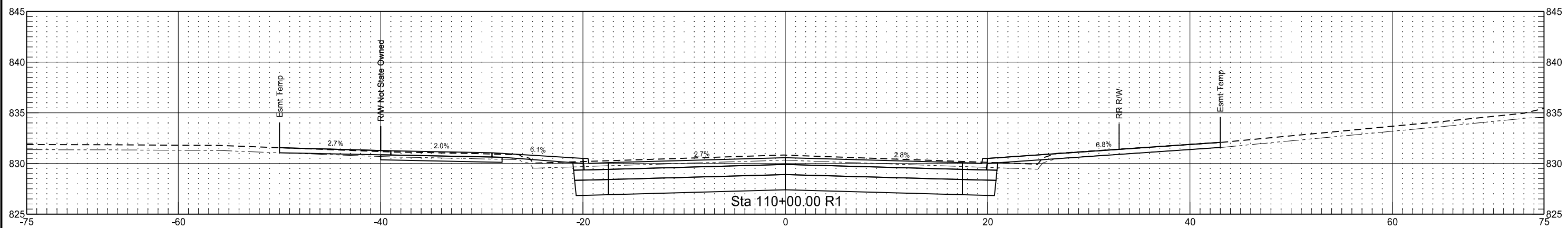
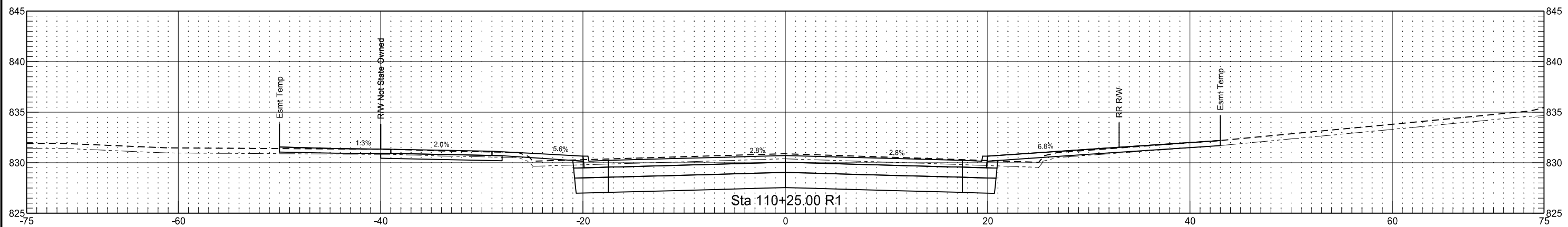
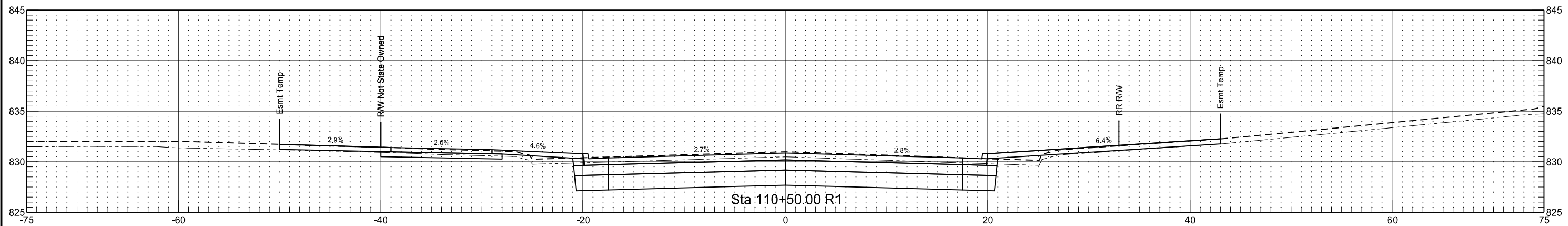

STATE	PROJECT NO.	SECTION NO.	SHEET NO.
ND	SU-6-986(121)125	200	29

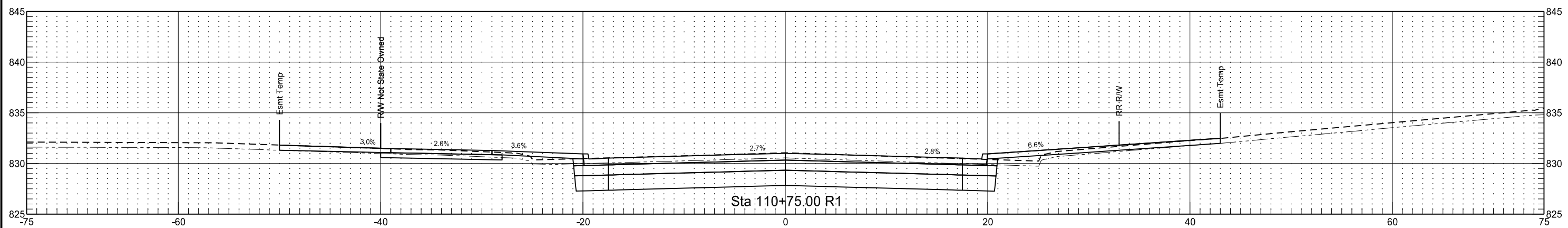
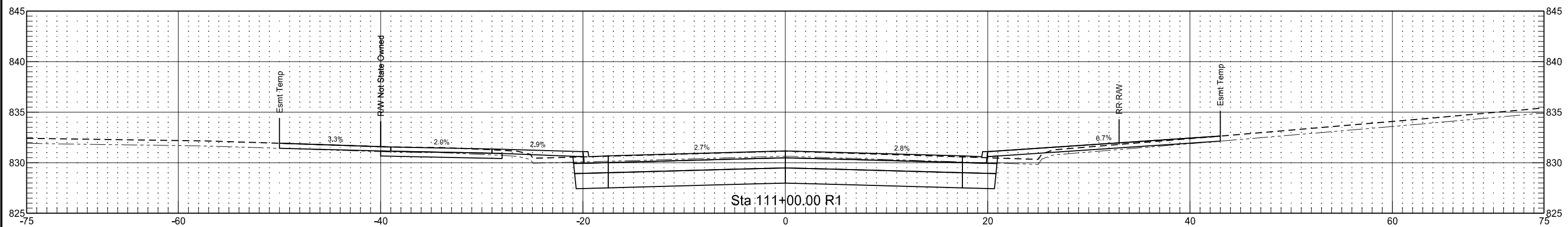
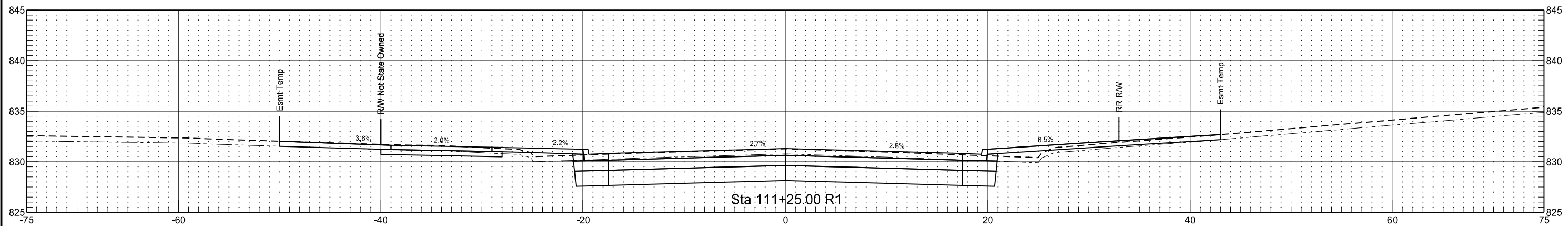

	STATE	PROJECT NO.	SECTION NO.	SHEET NO.
	ND	SU-6-986(121)125	200	30

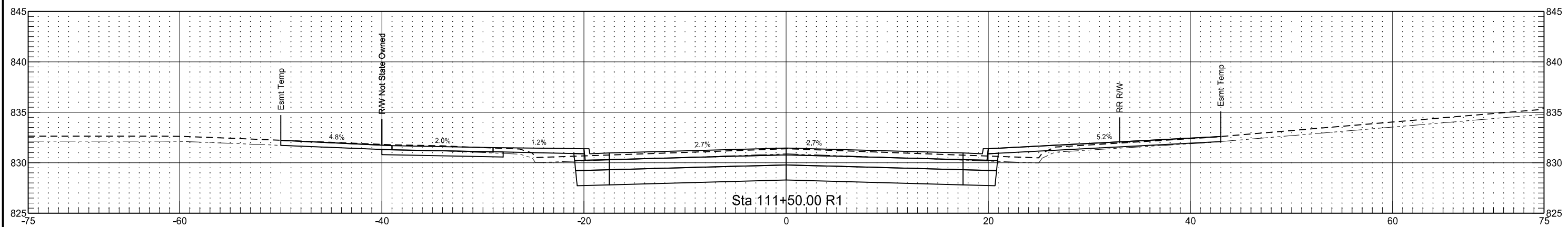
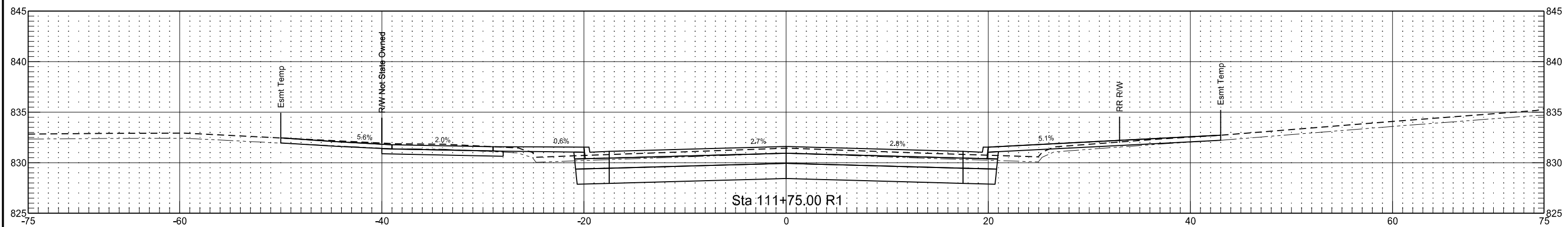
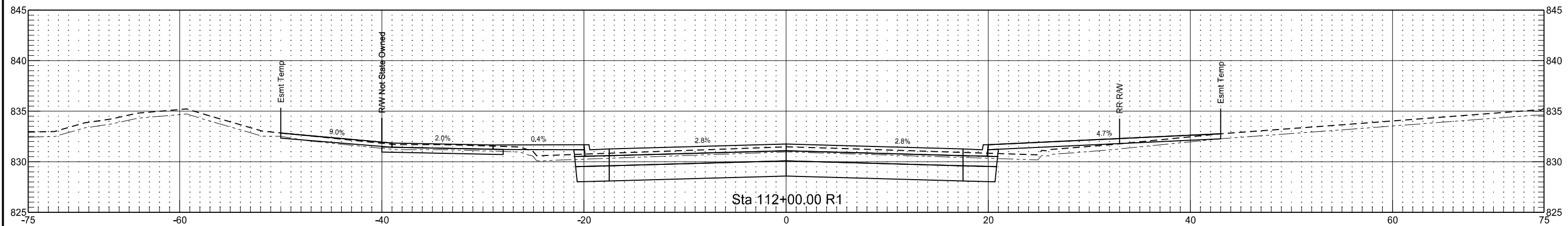

	STATE	PROJECT NO.	SECTION NO.	SHEET NO.
	ND	SU-6-986(121)125	200	31

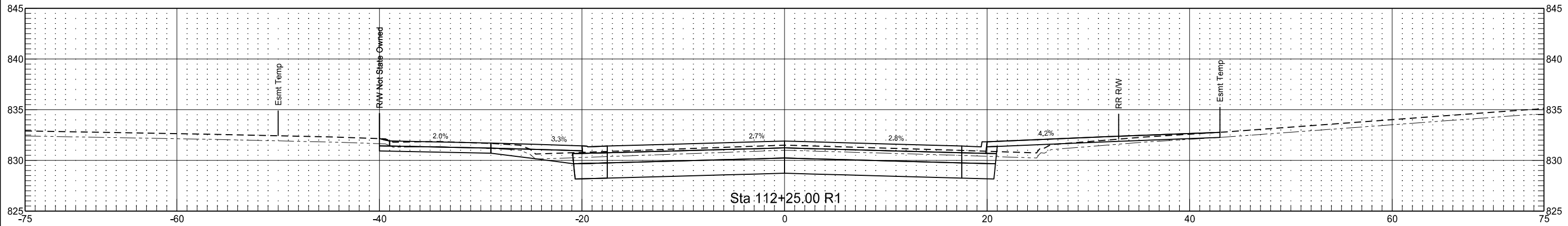
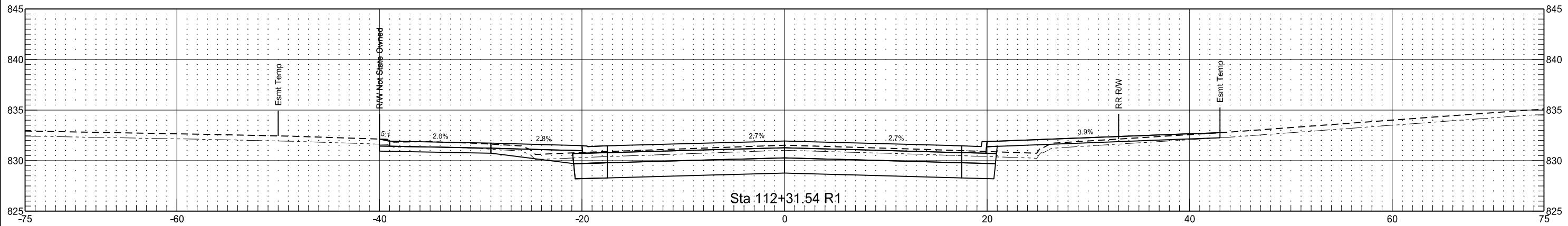
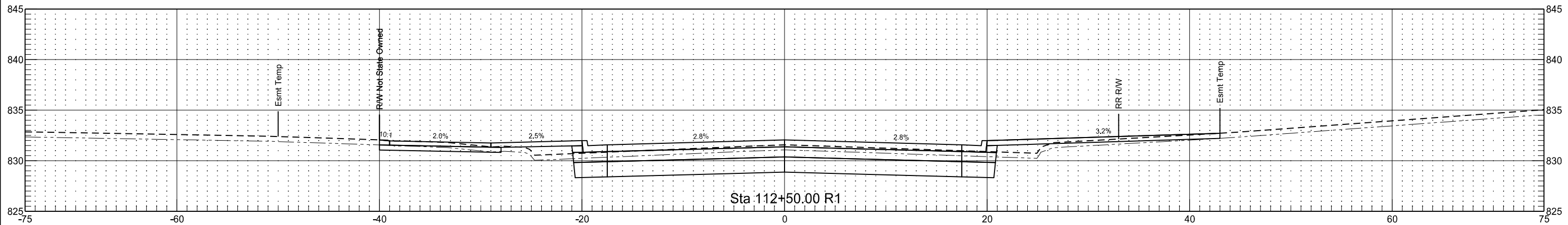

	STATE	PROJECT NO.	SECTION NO.	SHEET NO.
	ND	SU-6-986(121)125	200	32

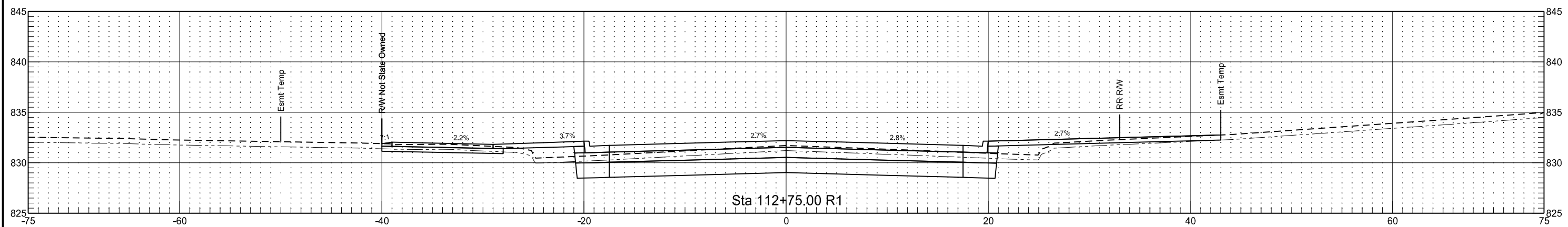
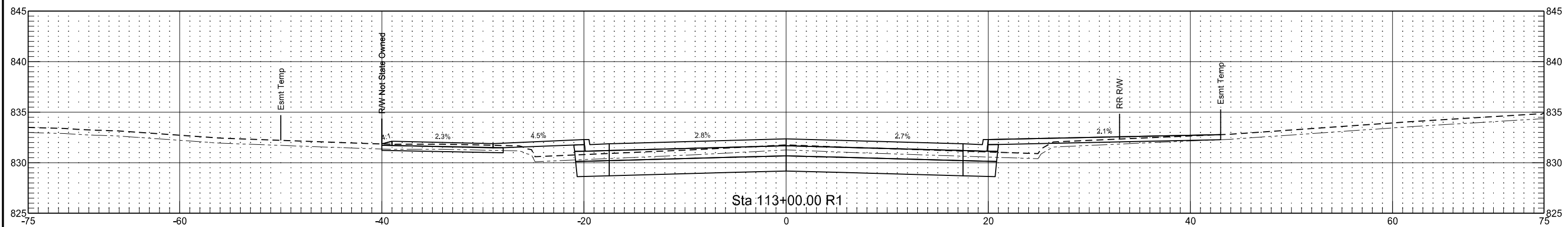
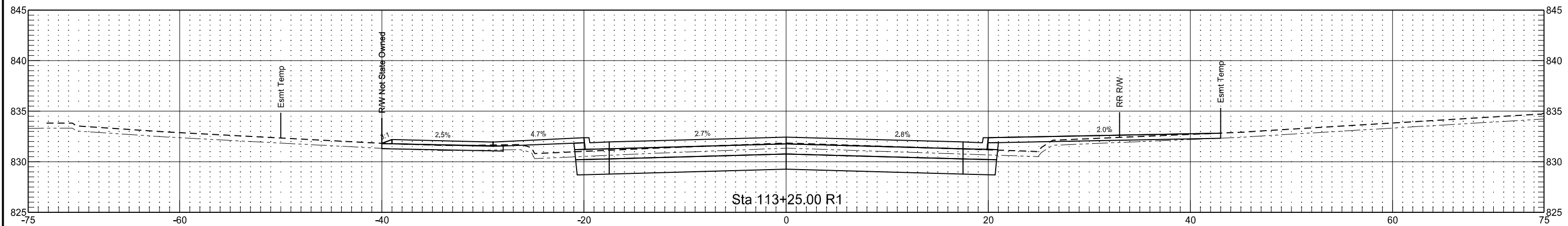



	STATE	PROJECT NO.	SECTION NO.	SHEET NO.
	ND	SU-6-986(121)125	200	33

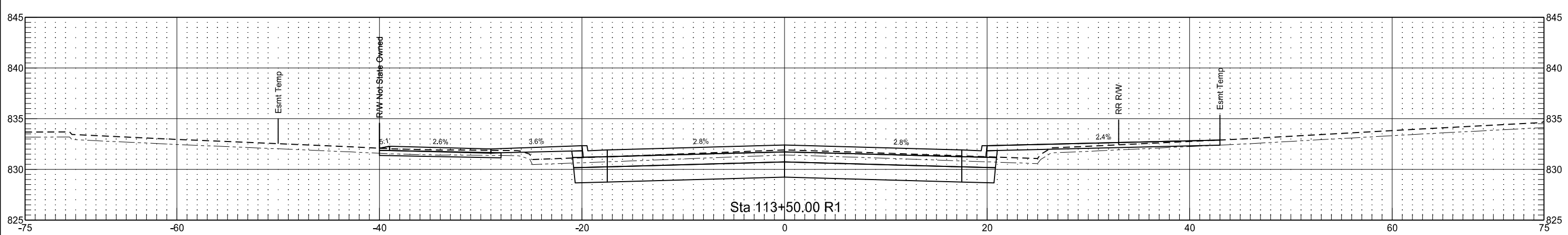
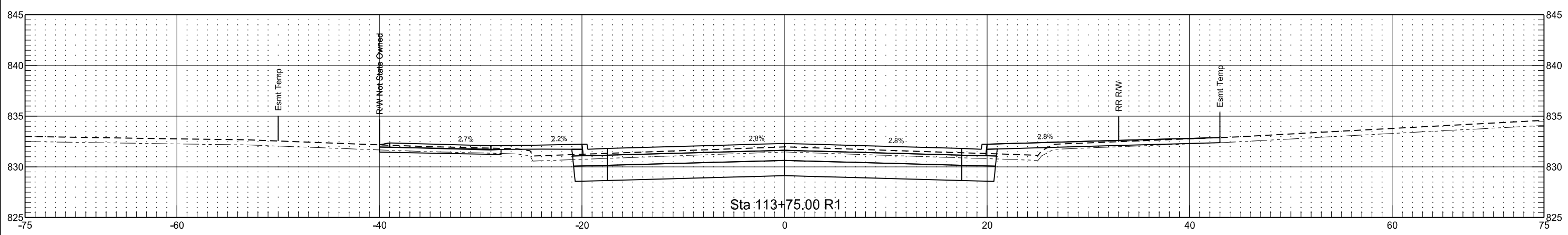
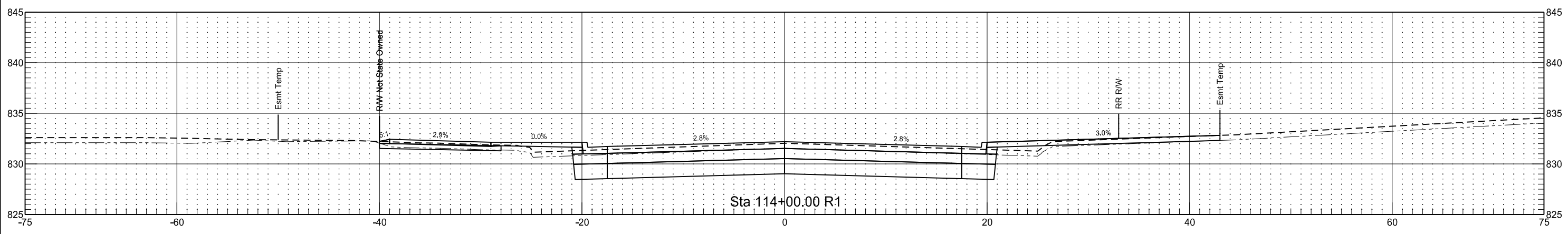

	STATE	PROJECT NO.	SECTION NO.	SHEET NO.
	ND	SU-6-986(121)125	200	34

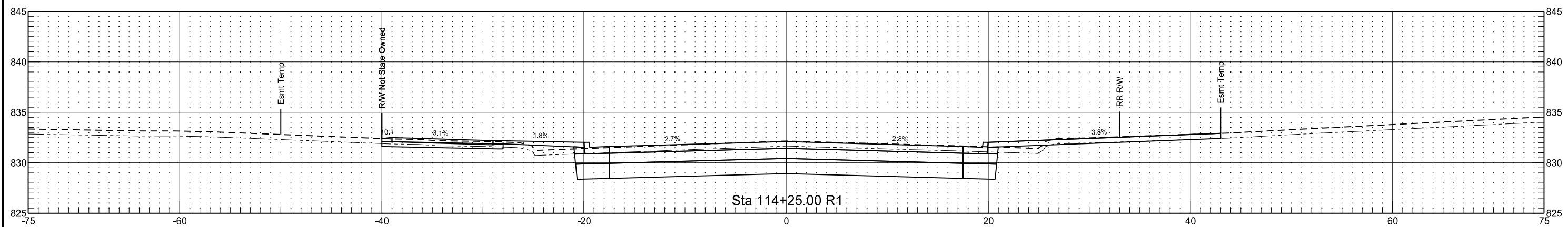
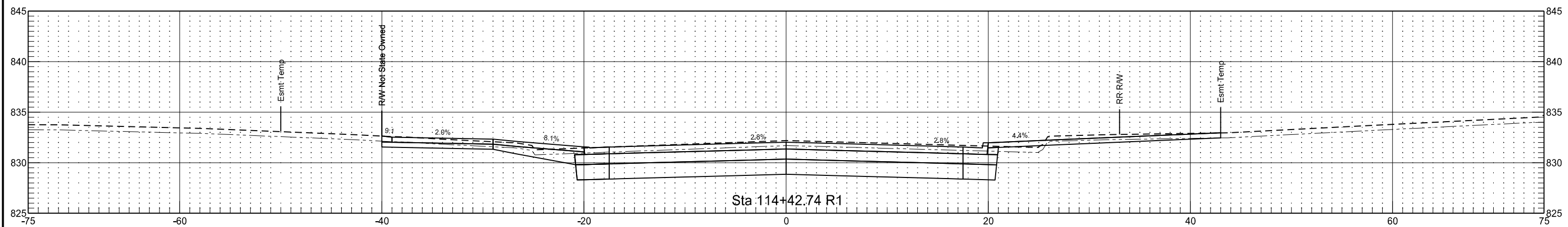
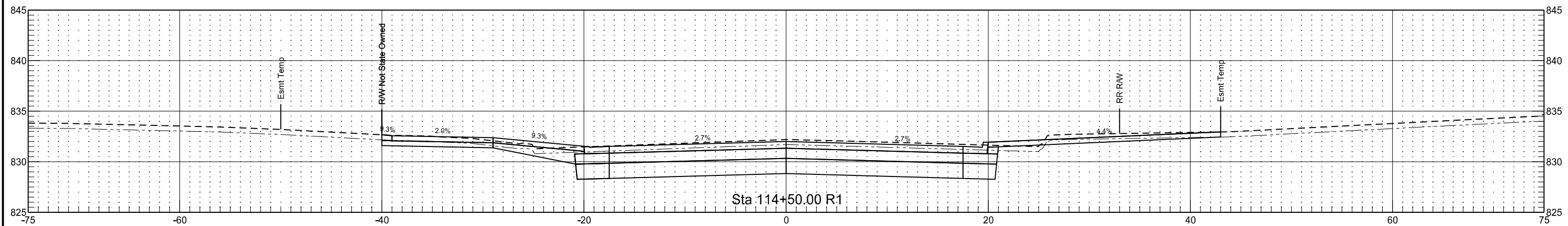

	STATE	PROJECT NO.	SECTION NO.	SHEET NO.
	ND	SU-6-986(121)125	200	35

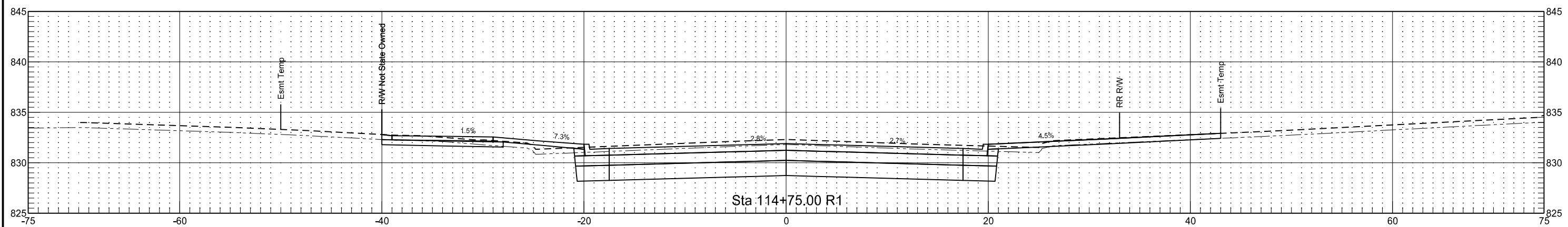
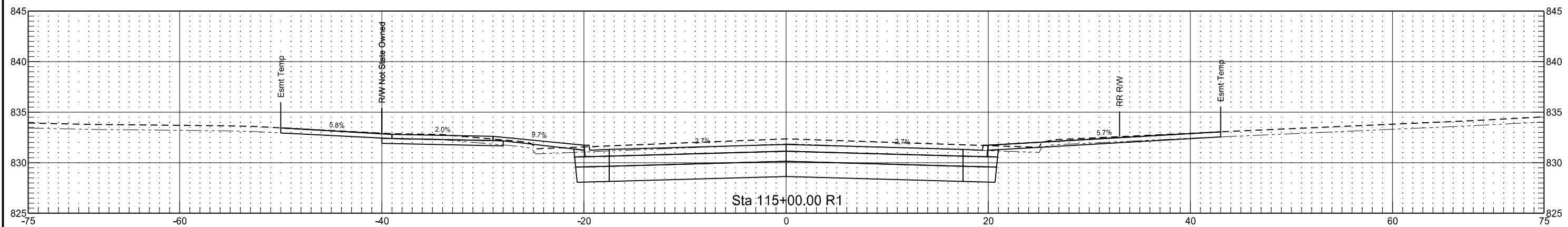
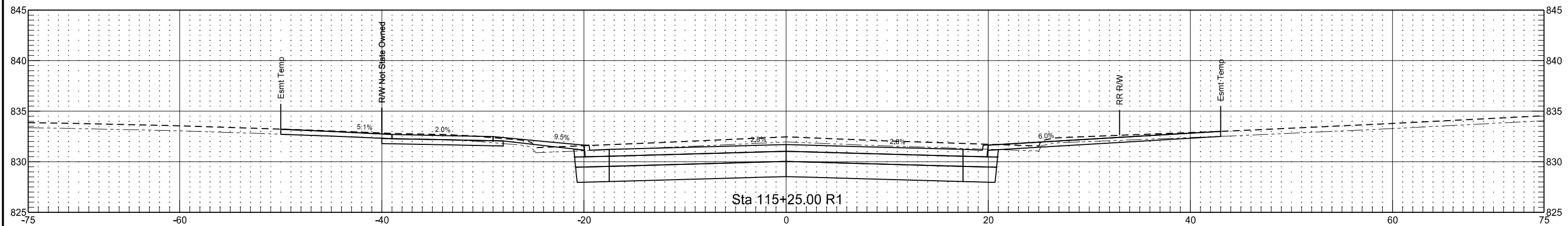

	STATE	PROJECT NO.	SECTION NO.	SHEET NO.
	ND	SU-6-986(121)125	200	36

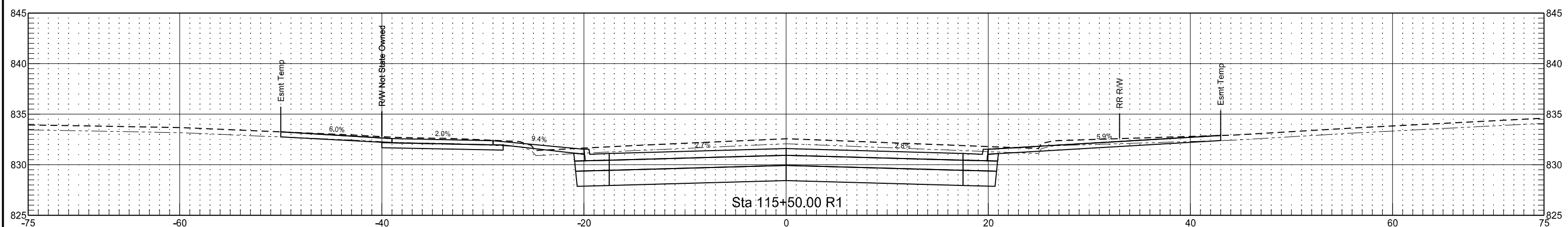
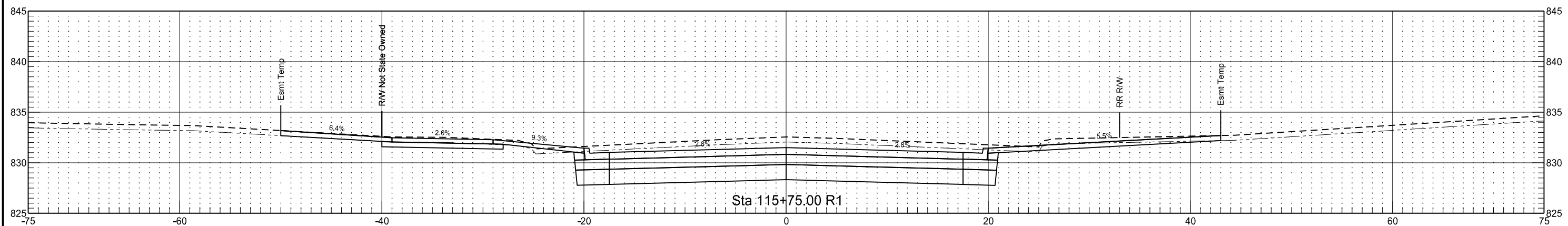
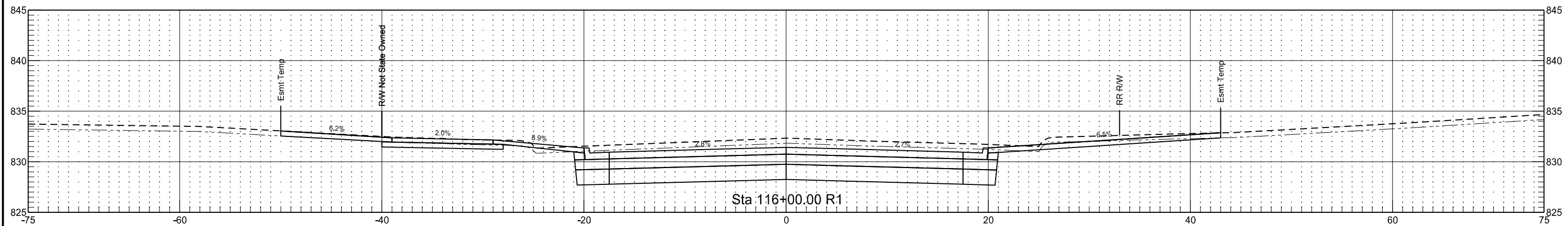

	STATE	PROJECT NO.	SECTION NO.	SHEET NO.
	ND	SU-6-986(121)125	200	37

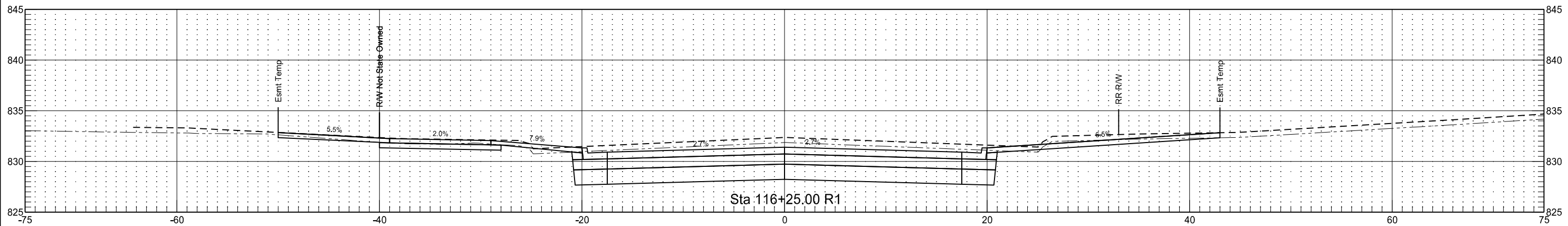
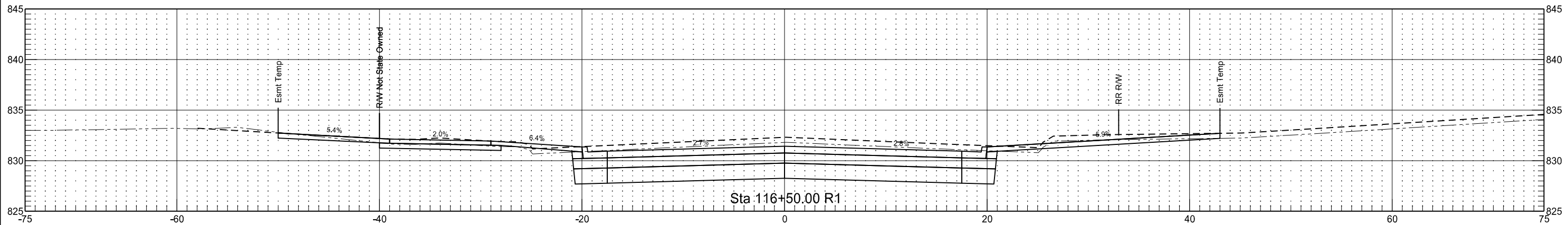
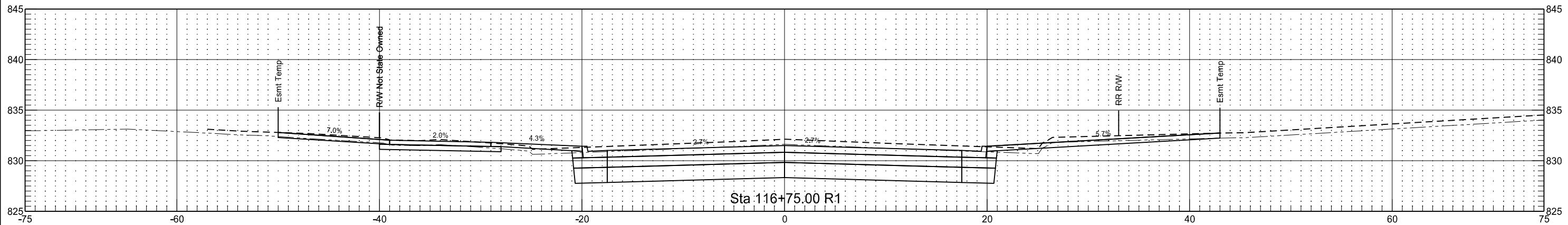

	STATE	PROJECT NO.	SECTION NO.	SHEET NO.
	ND	SU-6-986(121)125	200	38

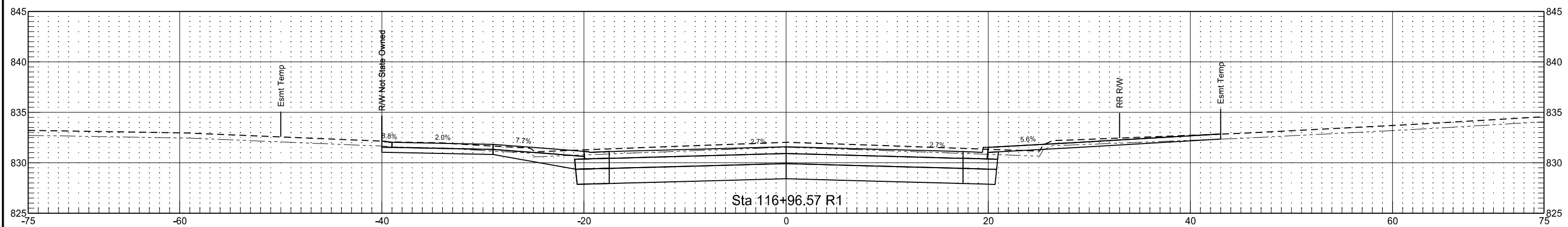
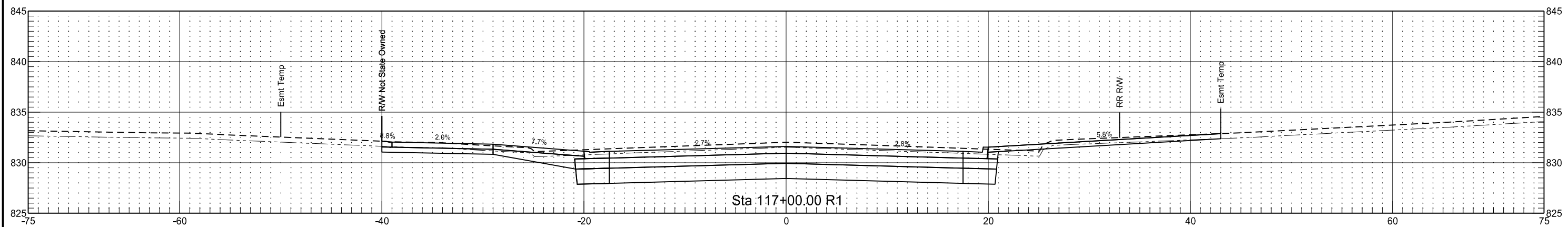
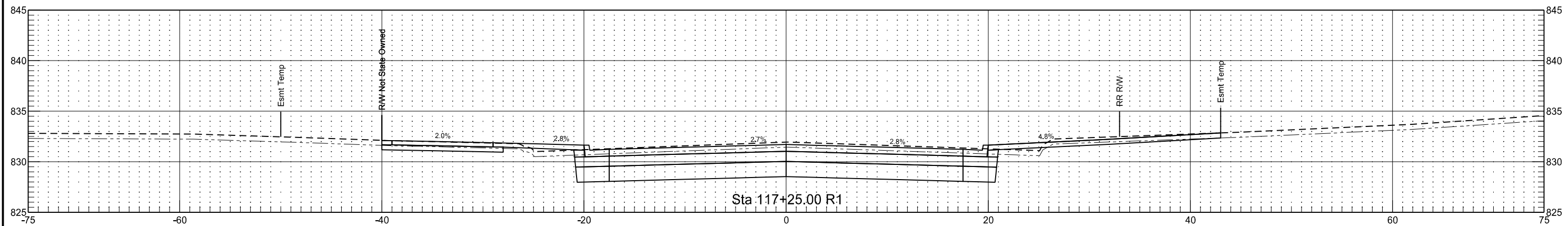

	STATE	PROJECT NO.	SECTION NO.	SHEET NO.
	ND	SU-6-986(121)125	200	39

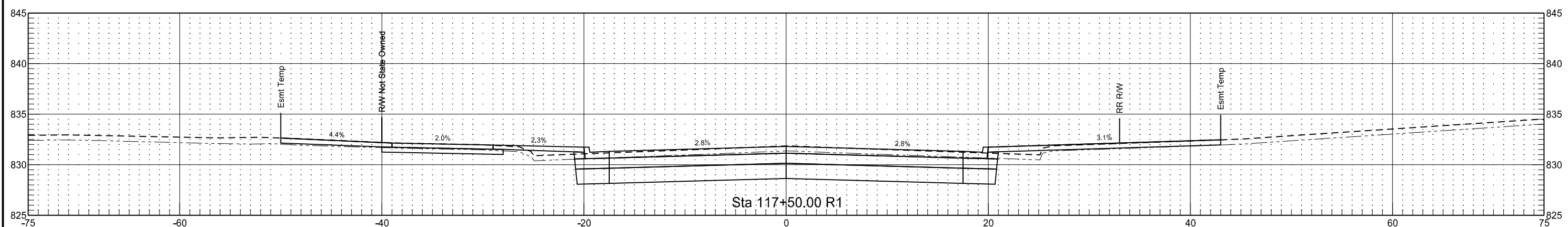
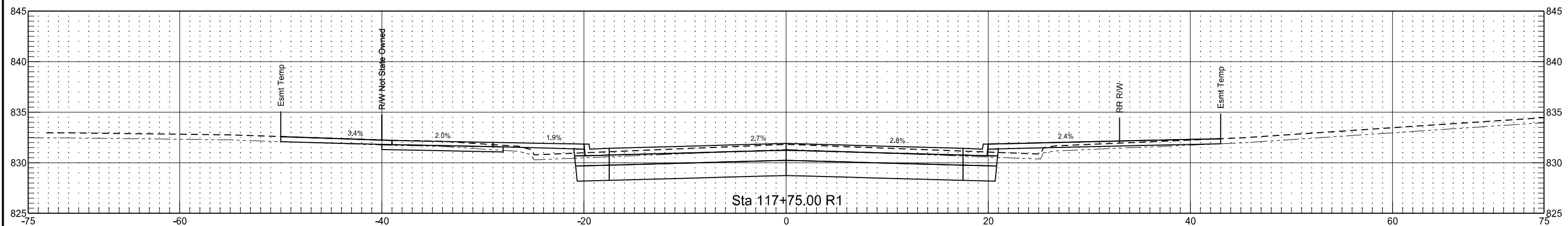
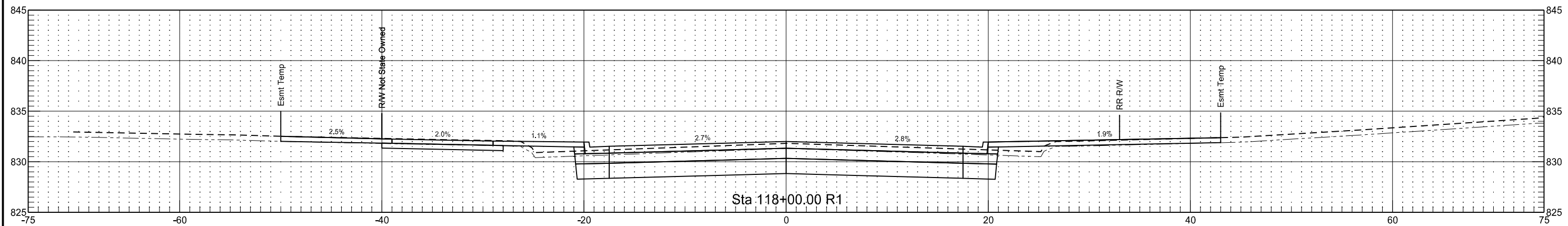

	STATE	PROJECT NO.	SECTION NO.	SHEET NO.
	ND	SU-6-986(121)125	200	40

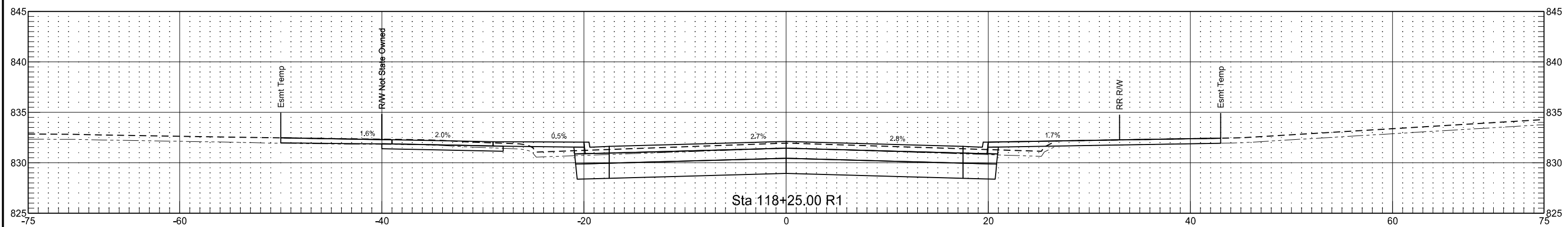
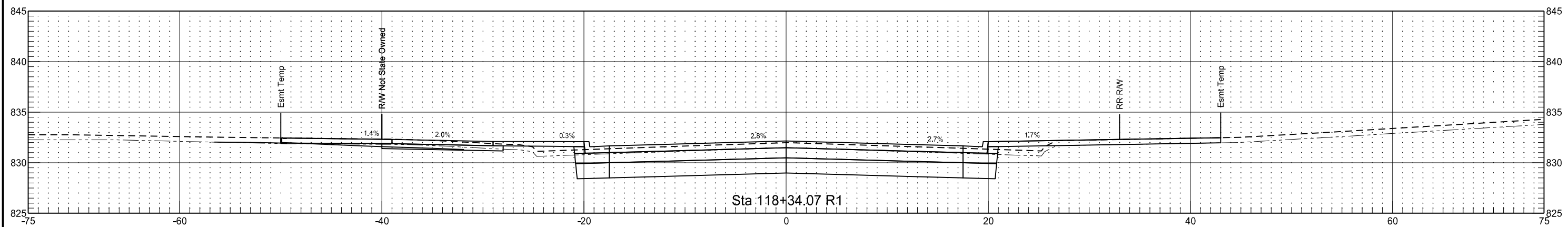
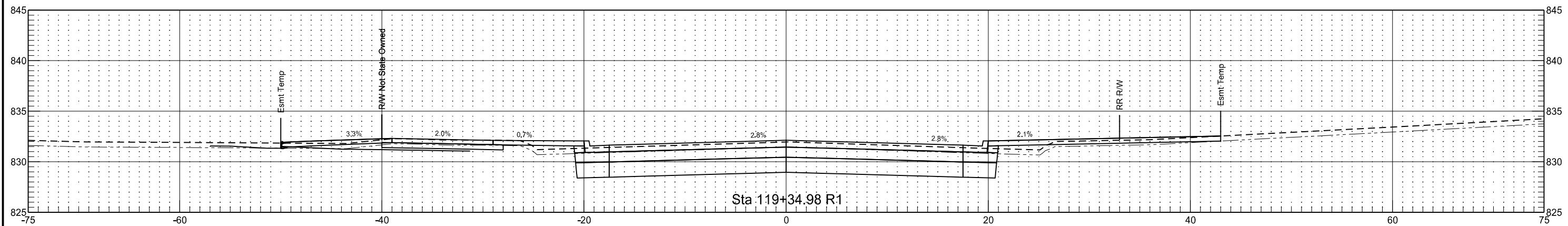



	STATE	PROJECT NO.	SECTION NO.	SHEET NO.
	ND	SU-6-986(121)125	200	41

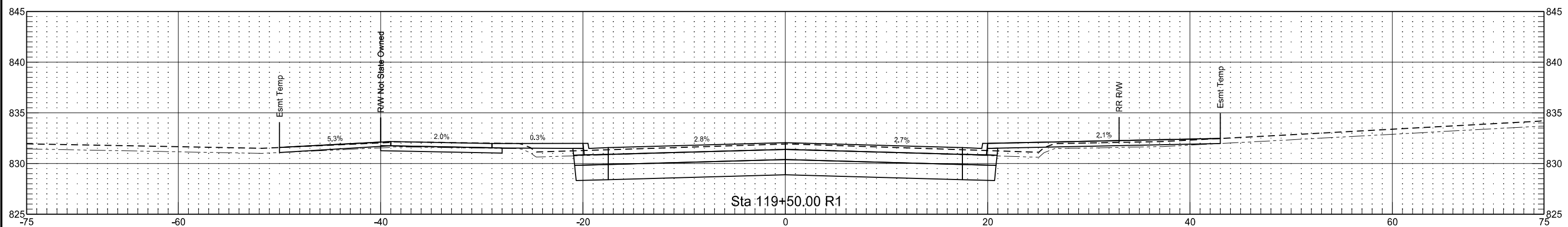
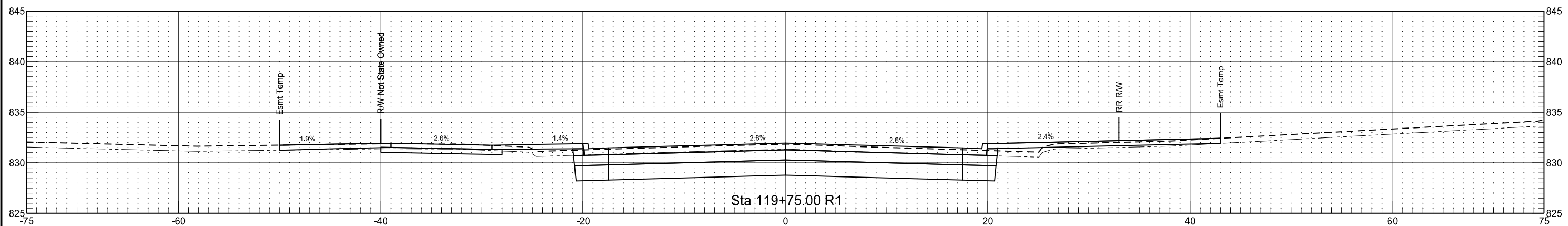
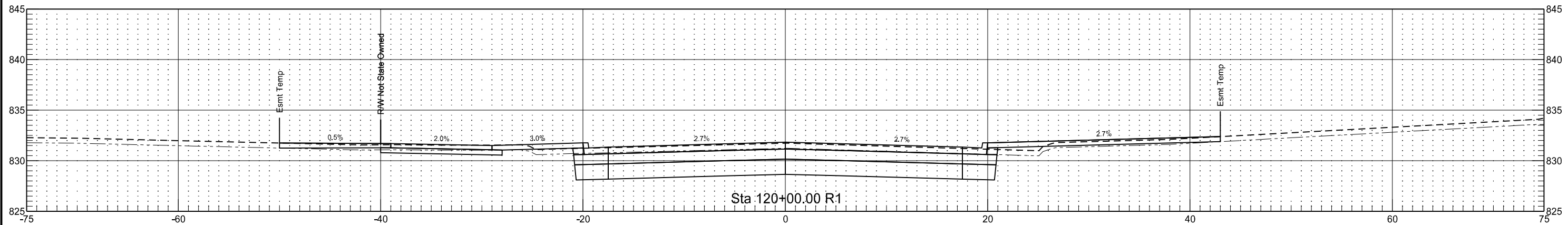

	STATE	PROJECT NO.	SECTION NO.	SHEET NO.
	ND	SU-6-986(121)125	200	42

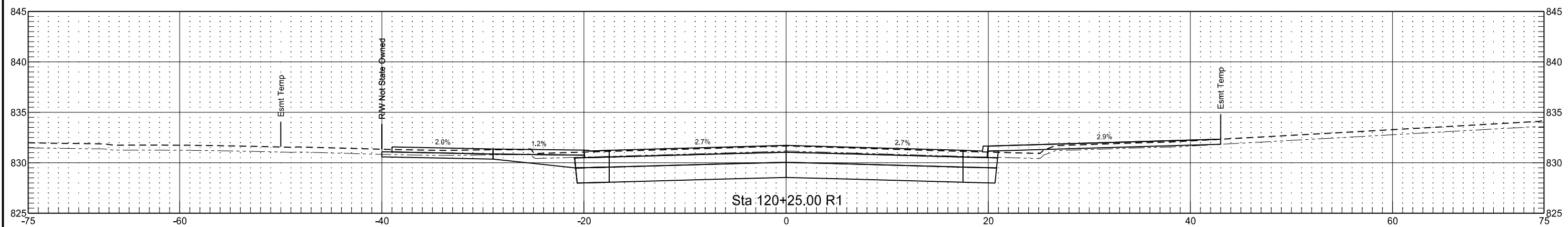
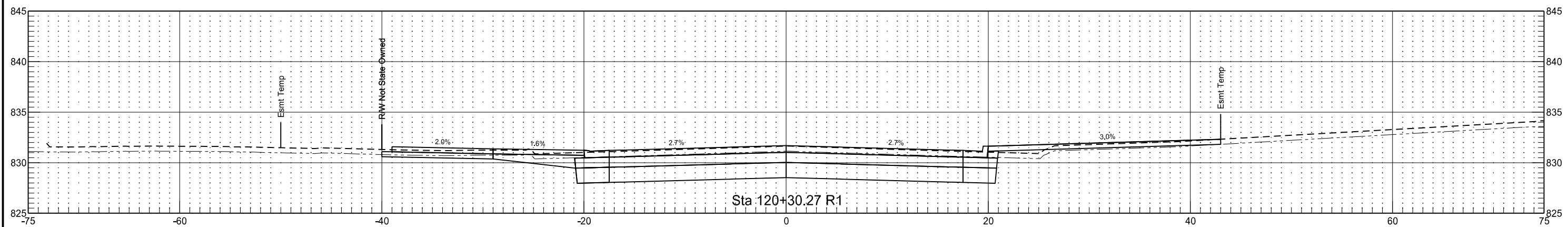
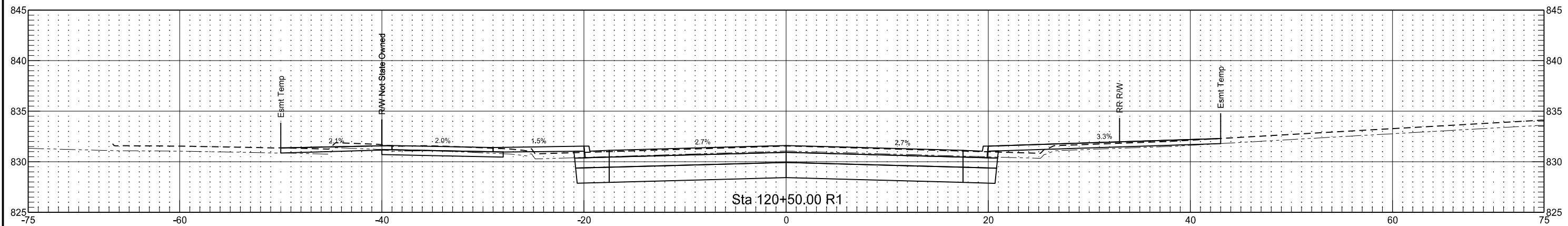

	STATE	PROJECT NO.	SECTION NO.	SHEET NO.
	ND	SU-6-986(121)125	200	43

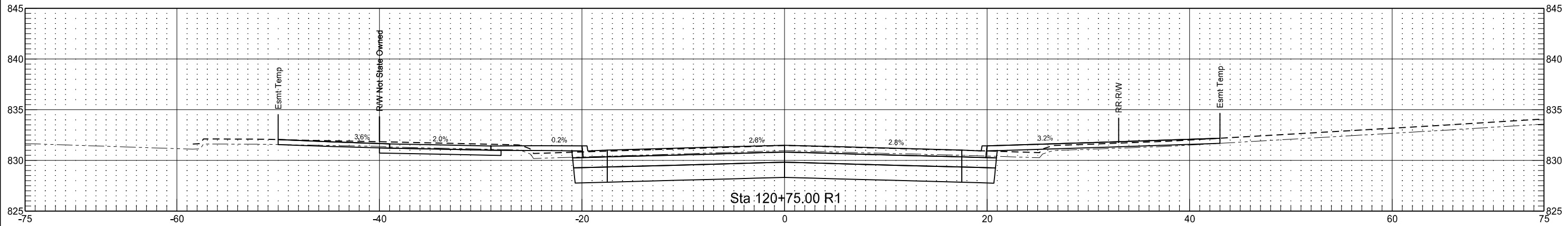
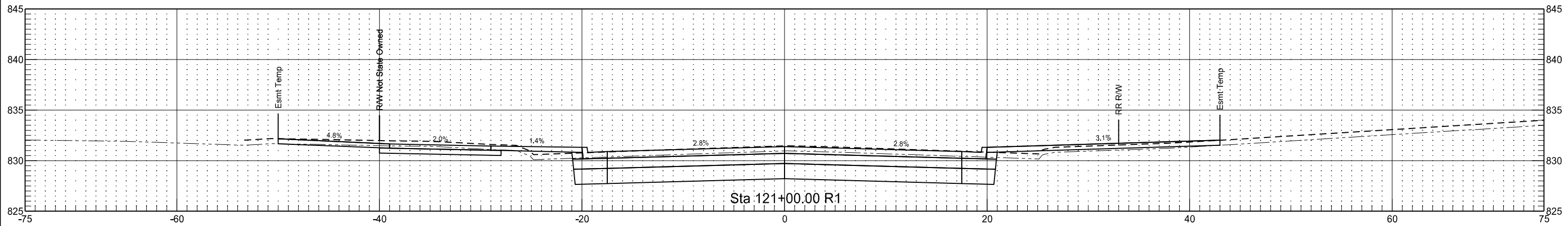
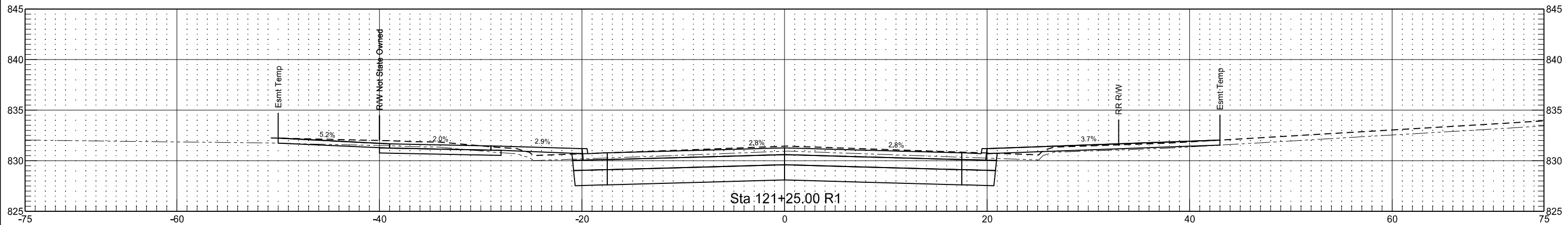

	STATE	PROJECT NO.	SECTION NO.	SHEET NO.
	ND	SU-6-986(121)125	200	44

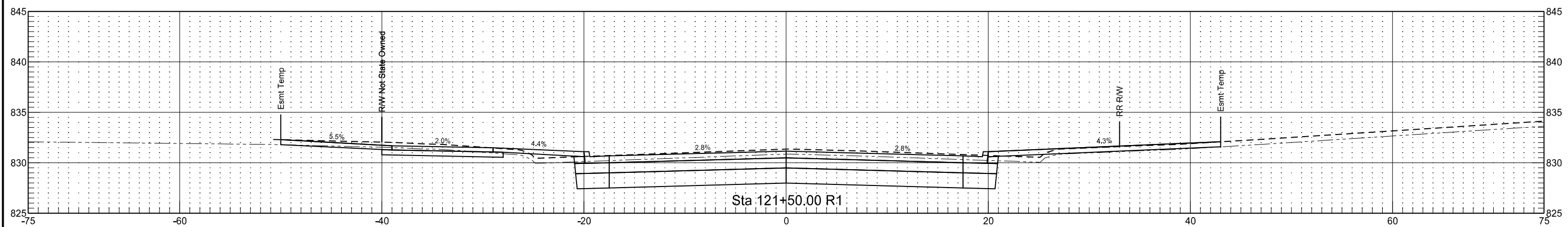
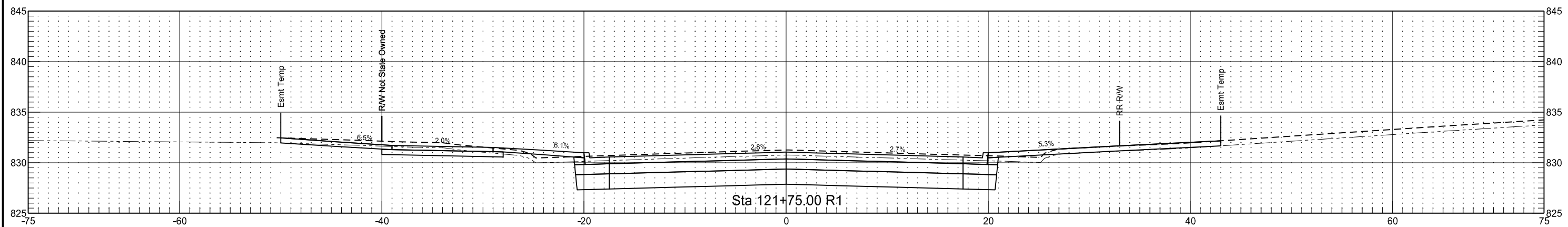
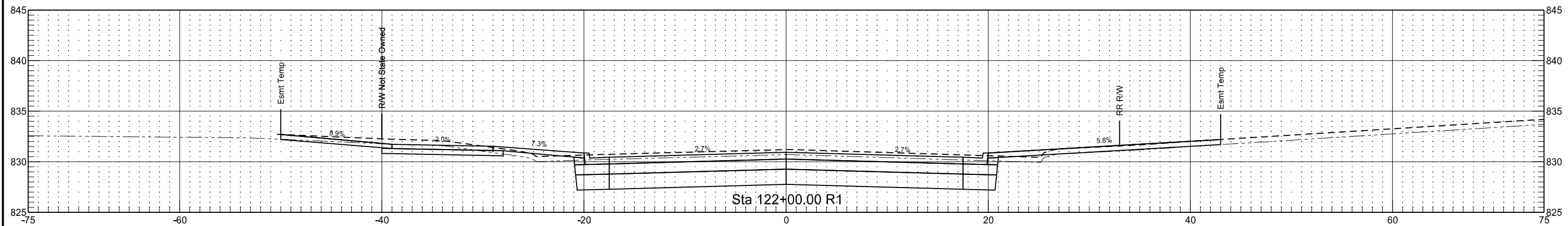

	STATE	PROJECT NO.	SECTION NO.	SHEET NO.
	ND	SU-6-986(121)125	200	45

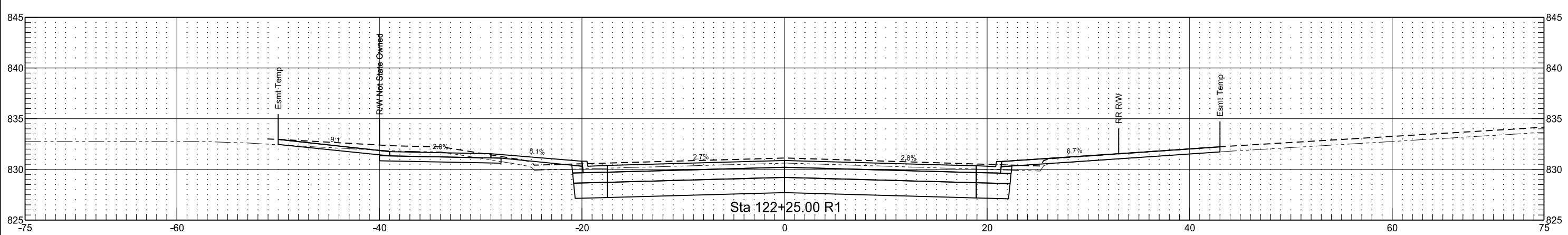
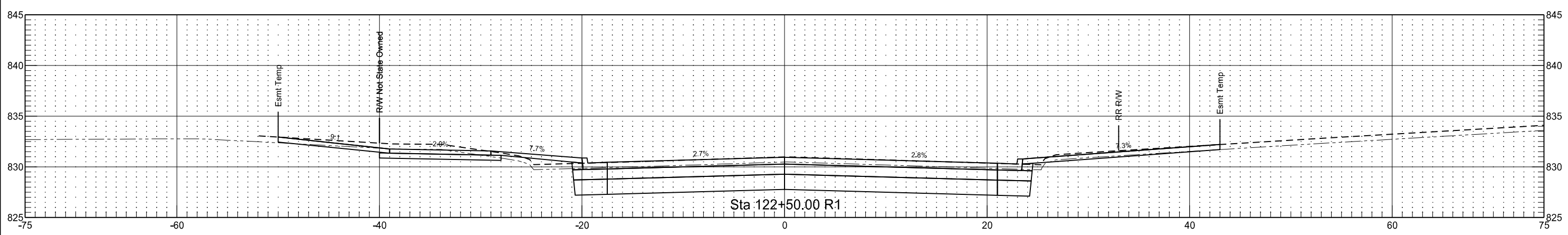
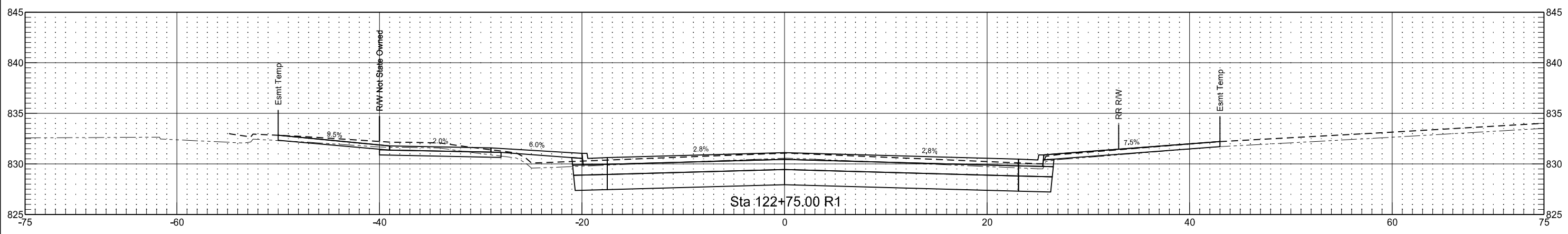

	STATE	PROJECT NO.	SECTION NO.	SHEET NO.
	ND	SU-6-986(121)125	200	46

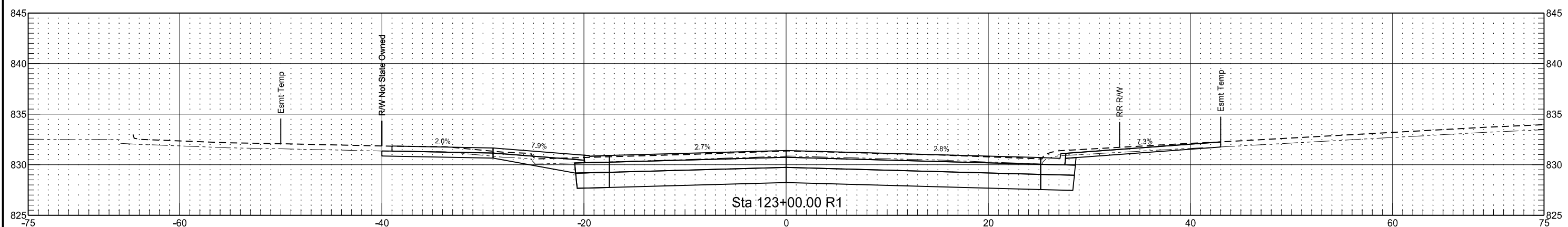
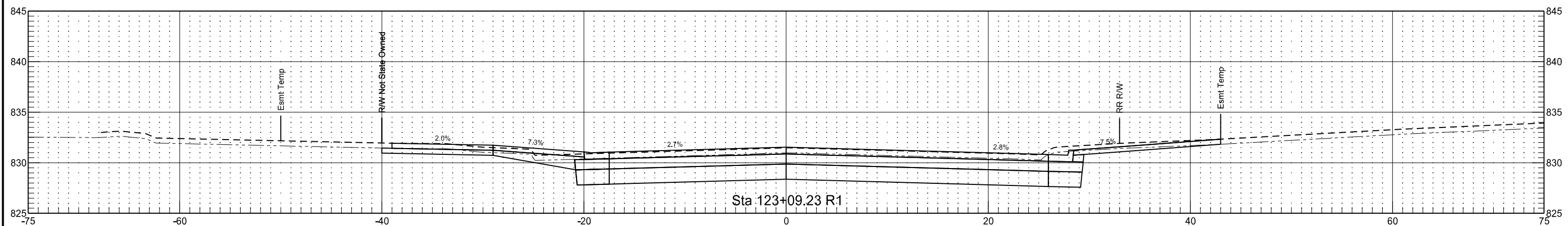
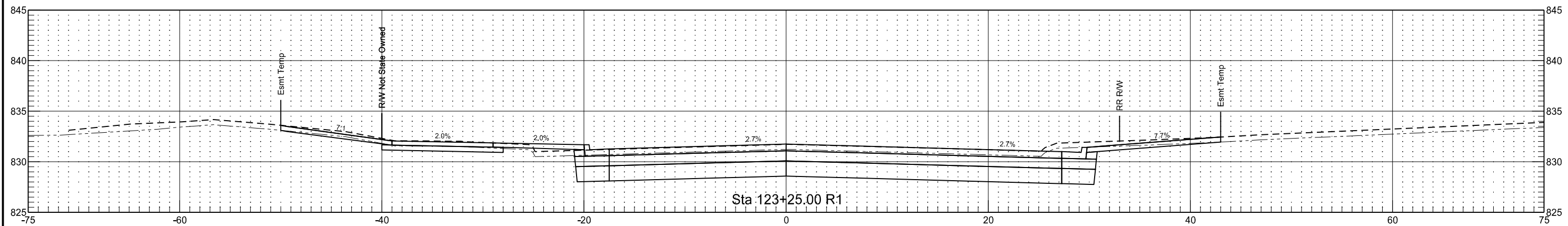

	STATE	PROJECT NO.	SECTION NO.	SHEET NO.
	ND	SU-6-986(121)125	200	47

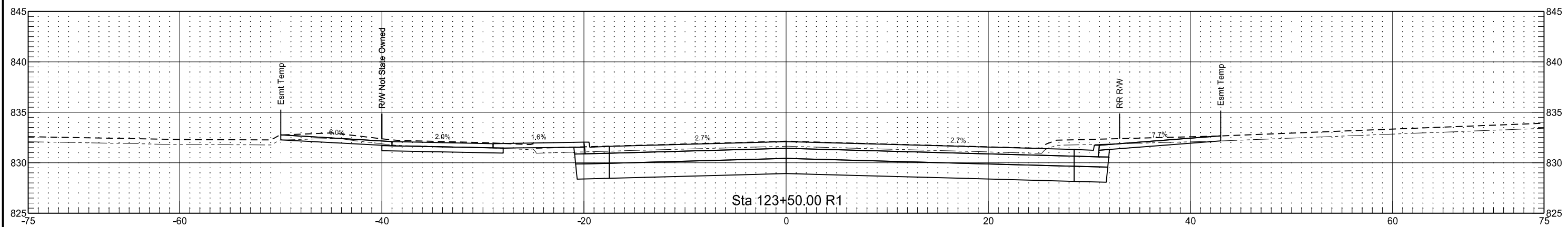
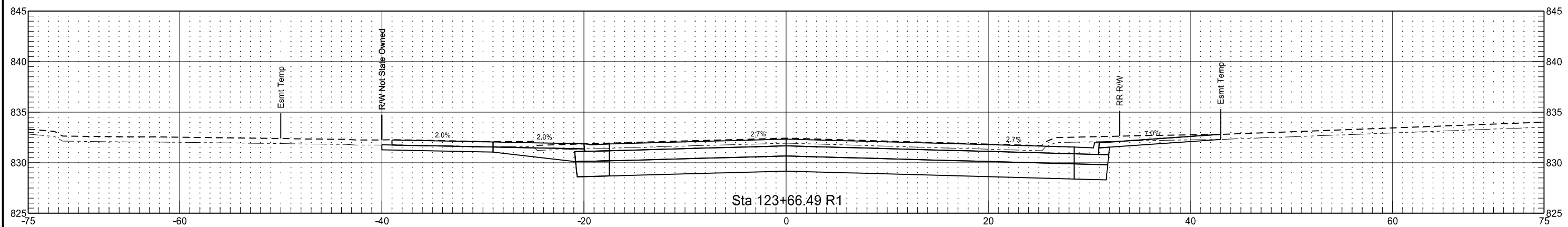
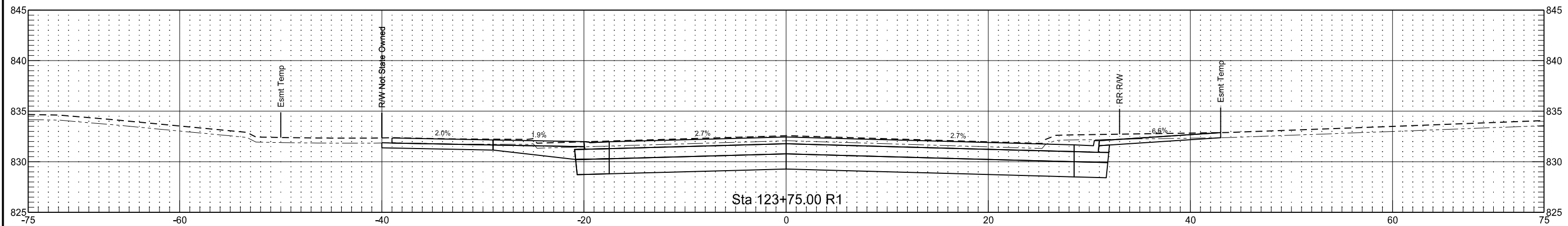

STATE	PROJECT NO.	SECTION NO.	SHEET NO.
ND	SU-6-986(121)125	200	48

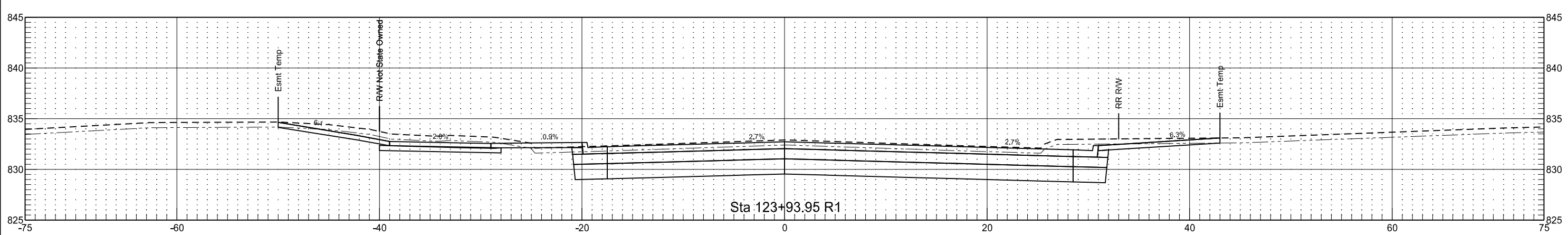
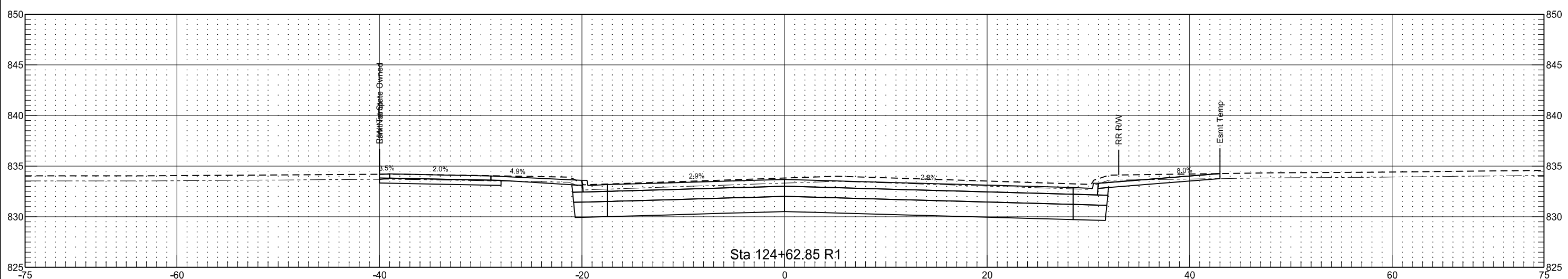
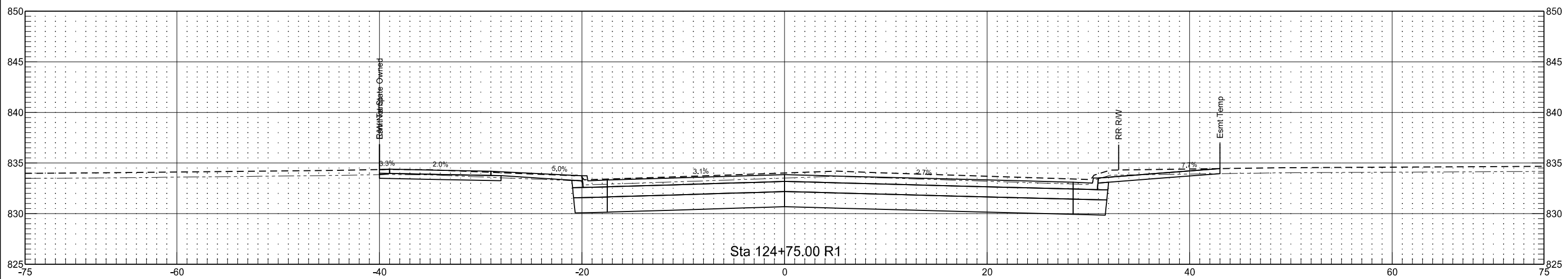



	STATE	PROJECT NO.	SECTION NO.	SHEET NO.
	ND	SU-6-986(121)125	200	49

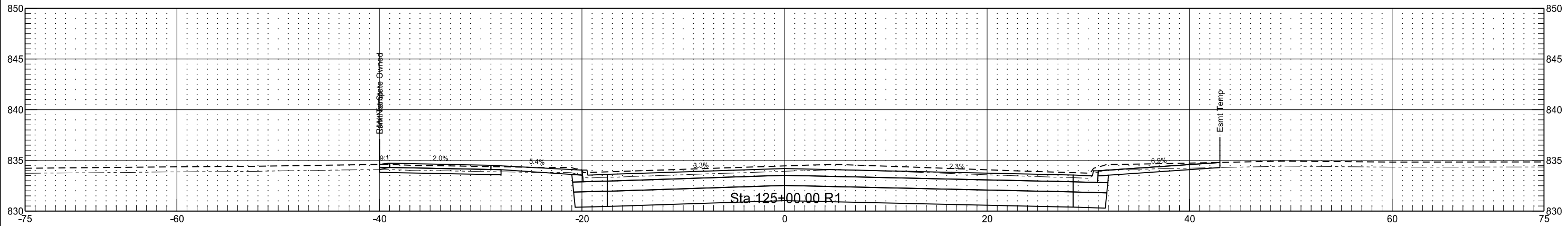
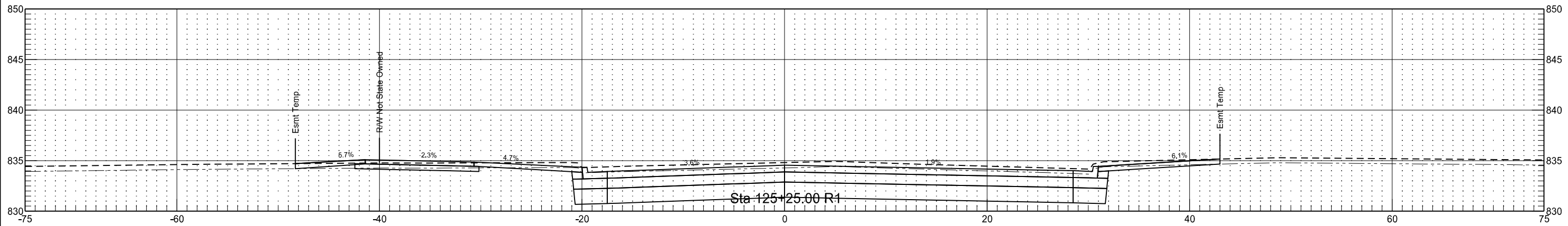
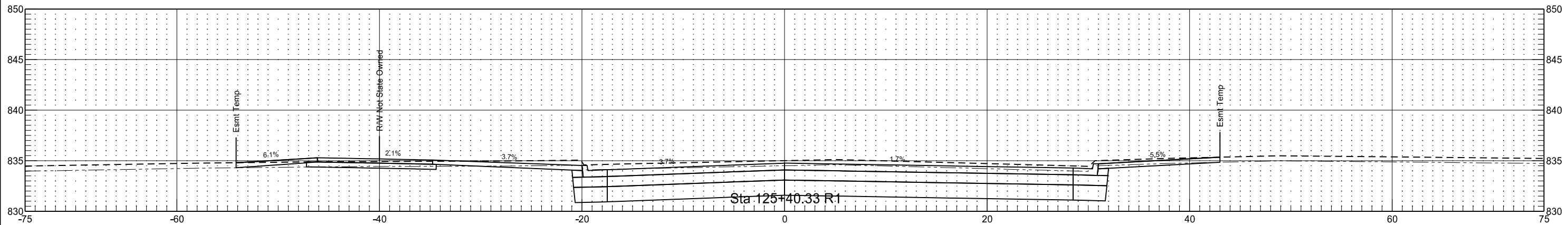

STATE	PROJECT NO.	SECTION NO.	SHEET NO.
ND	SU-6-986(121)125	200	50

